

1 Scope of supply

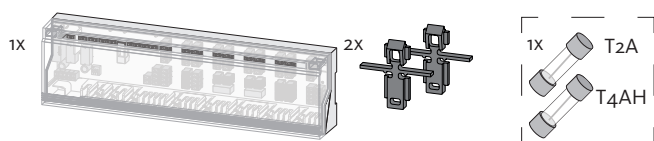

2 About these instructions

These instructions must be read completely and thoroughly before commencing any work with the base. These instructions must be kept and to be handed over to future users.

The following symbols show

- a list,
- a warning with respect to electrical voltage
- an important information.

3 Safety

3.1 Intended use

The base serves

- for the arrangement of a room-by-room temperature control system with a maximum of 6 zones (depending on the type used) for heating and cooling systems,
- the connection of a maximum of 15 actuators and 10 room control units (depending on the type used),
- the connection of actuators with the control direction NC (normally closed) or NO (normally open), depending on the thermostat used,
- the connection of an external timer,
- depending on the type used, the connection of a pump or a boiler, a CO signal generator, a temperature limiter or dew point sensor,
- a fixed installation.

Every other use, modification and conversion is expressly forbidden and leads to dangers the manufacturer cannot be held liable for.

3.2 Safety notes

All safety notes in these instructions must be observed in order to avoid accidents with personal damage or property damage.

WARNING

Danger to life due to the electrical voltage at the base station!

- Always disconnect from the mains network and secure against unintended activation before opening.
- Only an authorised electrician may open the device.
- Disconnect external voltages and secure against activation.
- Only use the product if it is in flawless state.
- Do not operate the device without device cover.
- This unit is not intended to be used by persons (including children) with restricted physical, sensory or mental skills or who lack experience or knowledge. If necessary, these persons must be supervised by a person responsible for their safety or receive instructions from this person on how to use this unit.
- Ensure that children do not play with this device. Children must be monitored if necessary.
- In case of emergency, disconnect the complete room-by-room temperature control system.

4 Device overview

4.1 Connections and indications

The following instructions show the full equipment. Individual positions may be omitted depending on the present base.

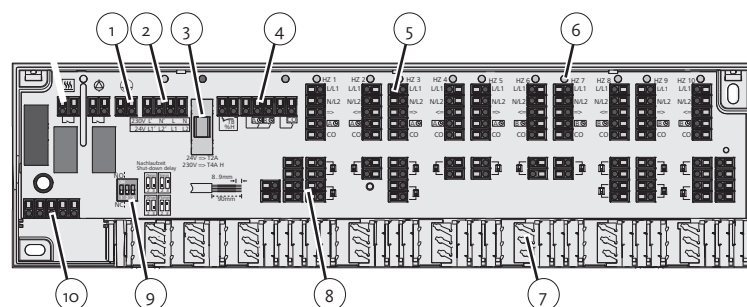

- | | |
|--|---|
| 1 Protective conductor connection (only for 230 V) | 7 Strain relief |
| 2 Voltage supply | 8 Connection of actuators |
| 3 Fuse | 9 DIP switch |
| 4 Reduction channel, external timer | 10 Contacts for casing cover with integrated system clock |
| 5 Thermostat connection | |
| 6 LEDs | |

4.2 Technical data

Operating voltage:	24 V \pm 20 %, 50 Hz 230 V \pm 10 %, 50 Hz
Power input 24 V / 230 V:	max. 30 VA / max. 50 VA
Fuse 24 V / 230 V:	T2A / T4AH
Number of heating zones:	6
Connectable actuators	
Type	A 20x05, A 21x05, A 40x05, A 41x05, AST 20x05, AST 21x05, AST 40x05, AST 41x05
6 / 10 heating zones:	max. 15
The following applies to other actuators than those mentioned above	
Inrush current per actuator:	500 mA (for 230 V)
Nominal load of all actuators:	max. 24 W (for 24 V)
Pump/boiler control ²	
Switching power:	2 A, 200 VA inductive
Turn-on delay:	2 min
Follow-up time fixed/adjustable:	2 min / 5 - 15 min
Pump protection function:	14 days for 1 minute
Control direction:	NC or NO ¹
Ambient temperature:	0 to +50 °C
Storage temperature:	-20 to +70 °C
Ambient humidity:	80%, not condensing
Temperature for ball pressure test:	550 °C
Pollution:	2
Rated impulse voltage:	1500 V
ERP class acc. to EU 811/2013:	1=1 %
Protection class 24 V / 230 V:	III / II
Protection type:	IP 20
Type action:	Type 1 / Type 1.C
Dimensions (H x L x D):	90 x 326.5 x 50 mm

4.3 Conformity

This product is labelled with the CE Marking and thus is in compliance with the requirements from the guidelines:

- 2004/108/EG with amendments "Council Directive on the approximation of the laws of the Member States relating to Electromagnetic Compatibility"
- 2006/95/EG with amendments "Council for Coordination of the Regulations of EU Member Countries regarding the electrical equipment for use within certain voltage limits"
- 2011/65/EU "Restriction of the Use of Certain Hazardous Substances in Electrical and Electronic Equipment"

Increased protection requirements may exist for the overall installation, the compliance of which is the responsibility of the installer.

5 Installation

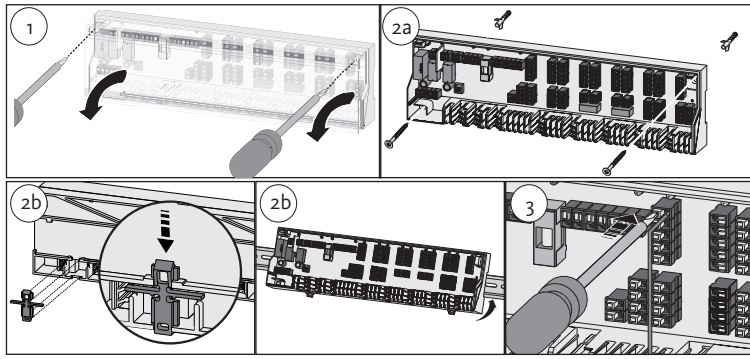

1. Take off the cover.
2. Install the base. In case of wall mounting, fix the base to the wall with 2 screws \varnothing 4 mm and corresponding dowels according to the quality of the wall. In case of installation on a mounting bracket, use a bracket TS 35/7.5.
3. Make the electric connection.
4. Install the cover.

5.1 Select and insert the fuse

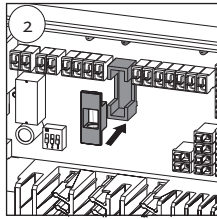
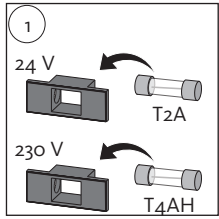

Depending on the fuse inserted (included in the scope of delivery) the CU-6ZONE can be operated at 24 V or 230 V voltage sources.

i The voltage used must be marked on the identification plate.

7 Maintenance

7.1 Fuse change



WARNING Electrical voltage! Danger to life!

- Always disconnect the base from the mains network and secure against unintended activation before opening.
- Disconnect external voltages and secure against unintended activation.

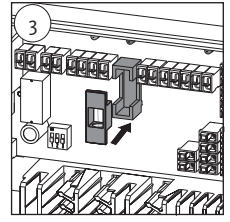
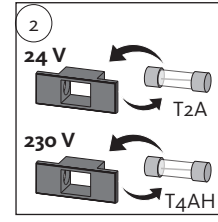
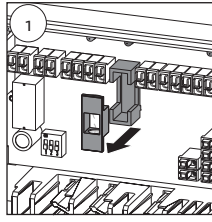

7.2 Cleaning

Only use a dry and solvent-free, soft cloth for cleaning.

8 Dismantling



WARNING! Electrical voltage! Danger to life!

- Always disconnect the base from the mains network and secure against unintended activation before opening.
- Disconnect external voltages and secure against unintended activation.
- De-energise the complete installation.
- Remove the wiring to all externally connected components.
- Remove the base and dispose it of properly, if necessary.

6 Electric connection

For the connection of the voltage supply, the cable sections must be a minimum of 0.75 mm² for 24 V or 1.5 mm² for 230 V. The voltage supply of the 24 V version must come from a safety transformer according to EN 61558-2-6 or, for North America, from a Class II Transformer according to UL. Depending on the voltage version of the base, it is possible to take L1 or L and L2 or N, as well as the protective conductor, from the base. If no temperature limiter is connected, the connection TB/%H must be bridged (provided for at the factory). The bridge must be removed as soon as a temperature limiter is connected. The temperature limiter must be a normally closed contact.



The wiring of the thermostats depends on the present basis. For wiring purposes, please observe the instructions of the thermostat or of the respective component.

- Digital controller
- Analogous thermostat
- Actuator
- Voltage source
- Temperature limiter
- System clock

