



# PRODUCT OVERVIEW 2019/1



HENCO PRODUCT OVERVIEW 2019/1



RADIATOR



SANITARY



FLOOR HEATING

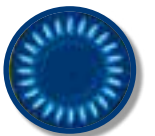

GAS

EN/NL/FR/DE

EN/NL/FR/DE



# PRODUCT OVERVIEW

## 2019/1

WE CARE TO CONNECT



<b>Pipes</b>		4	<b>1</b>
A. STANDARD (PE-Xc/AL/PE-Xc)		5	
B. RIXc (PE-Xc/AL/PE-Xc)		14	
C. FLOOR-RIXc (PE-Xc/AL/PE-Xc)		15	
D. PE-Xc		16	
E. PE-RT		17	
F. PROTECTION HOSE		18	
G. GAS STANDARD (PE-Xc/AL/PE-Xc)		19	
H. SPRINKLER		20	
<b>Henco Press</b>		21	<b>2</b>
A. PK		22	
B. PKW		35	
C. PKG		42	
D. PKS (SPRINKLER)		47	
E. SUPER SIZE		53	
F. HENCO ECOLINE		59	
<b>Henco Vision</b>		60	<b>3</b>
A. SK		61	
B. MANIFOLDS		67	
<b>Brass Press fittings</b>		72	<b>4</b>
A. P		73	
B. PG		87	
<b>Brass Compression fittings</b>		91	<b>5</b>
<b>Manifolds</b>		100	<b>6</b>
<b>Valves</b>		106	<b>7</b>
<b>Underfloor heating</b>		112	<b>8</b>
A. SYSTEMS		113	
B. MANIFOLDS		125	
C. CONTROL UNITS		136	
D. GEOTHERMAL		146	
<b>Cabinets</b>		147	<b>9</b>
<b>Tools</b>		149	<b>10</b>
<b>Accessories</b>		171	<b>11</b>
<b>Certificates</b>		175	



	<i>Page</i>
<b>A. STANDARD (PE-Xc/AL/PE-Xc)</b>	<b>5</b>
<b>B. RIXc (PE-Xc/AL/PE-Xc)</b>	<b>14</b>
<b>C. FLOOR-RIXc (PE-Xc/AL/PE-Xc)</b>	<b>15</b>
<b>D. PE-Xc</b>	<b>16</b>
<b>E. PE-RT</b>	<b>17</b>
<b>F. PROTECTION HOSE</b>	<b>18</b>
<b>G. GAS STANDARD (PE-Xc/AL/PE-Xc)</b>	<b>19</b>
<b>H. SPRINKLER</b>	<b>20</b>



## Type: COIL



Henco multilayer pipe (Coil)  
 Henco meerlagenbuis (Rol)  
 Henco tube multicouche (Rouleau)  
 Henco Mehrschichtverbundrohr (Ring)

Article number	m / Pallet	Type	Pallet dimension
100-121688 *	100 m / 2200 m	12x1,6	75x75 cm
200-121688 *	200 m / 3000 m	12x1,6	75x75 cm
100-140210	100 m / 2200 m	14x2	75x75 cm
200-140210	200 m / 3000 m	14x2	80x80 cm
50-160212	50 m / 1500 m	16x2	120x80 cm
100-160212	100 m / 2200 m	16x2	75x75 cm
200-160212	200 m / 2600 m	16x2	75x75 cm
500-160212D	500 m / 2500 m	16x2	80x80 cm
100-180214	100 m / 1700 m	18x2	75x75 cm
200-180214	200 m / 2000 m	18x2	75x75 cm
25-200216	25 m / 800 m	20x2	120x80 cm
50-200216	50 m / 1000 m	20x2	120x80 cm
100-200216	100 m / 1500 m	20x2	75x75 cm
50-260320	50 m / 800 m	26x3	75x75 cm
50-320326	50 m / 650 m	32x3	90x90 cm

\* 6 bar - 60°C

## Type: COIL CSC



Henco multilayer pipe (Coil Small Core)  
 Henco meerlagenbuis (Rol Kleine Kern)  
 Henco tube multicouche (Petit Rouleau Noyau intérieure)  
 Henco Mehrschichtverbundrohr (Ring kleinen Kern)

Article number	Pallet	Type	Pallet dimension
10-160212-KB	10 m / 800 m	16x2	120x80 cm
15-160212-KB	15 m / 900 m	16x2	120x80 cm
25-160212-KB	25 m / 1125 m	16x2	120x80 cm
25-200216-KB	25 m / 900 m	20x2	120x80 cm

ID Coil: 28cm

## A. STANDARD (PE-Xc/AL/PE-Xc)

### 1 Type: STRAIGHT LENGTH



Henco multilayer pipe (Straight length)

Henco meerlagenbuis (Stang)

Henco tube multicouche (Barre)

Henco Mehrschichtverbundrohr (Stange)

Article number	Cylinder / Pallet	Type	Pallet dimension
03-160212	75 m / 3600 m	16x2	310x70,5cm
04-160212	100 m / 4800 m	16x2	410x70,5 cm
05-160212	125 m / 6000 m	16x2	510x70,5 cm
03-180214	60 m 2880 m	18x2	310x70,5 cm
05-180214	100 m / 4800 m	18x2	510x70,5 cm
03-200216	54 m / 2592 m	20x2	310x70,5 cm
04-200216	72 m / 3456 m	20x2	410x70,5 cm
05-200216	90 m / 4320 m	20x2	510x70,5 cm
03-260320	30 m / 1440 m	26x3	310x70,5 cm
04-260320	40 m / 1920 m	26x3	410x70,5 cm
05-260320	50 m / 2400 m	26x3	510x70,5 cm
03-320326	21 m / 1008 m	32x3	310x70,5 cm
04-320326	28 m / 1344 m	32x3	410x70,5 cm
05-320326	35 m / 1680 m	32x3	510x70,5cm
03-403533	27 m / 648 m	40x3,5	310x70,5 cm
04-403533	36 m / 864 m	40x3,5	410x70,5 cm
05-403533	45 m / 1080 m	40x3,5	510x70,5 cm
03-504042	21 m / 504 m	50x4	310x70,5 cm
04-504042	28 m / 672 m	50x4	410x70,5 cm
05-504042	35 m / 840 m	50x4	510x70,5 cm
03-634554	12 m / 288 m	63x4,5	310x70,5 cm
04-634554	16 m / 384 m	63x4,5	410x70,5 cm
05-634554	20 m / 480 m	63x4,5	510x70,5 cm
05-756063	10 m / 240 m	75x6	510x70,5 cm
05-907076	5 m / 240 m	90x7	510x70,5 cm

### Type: ISO4 (6 mm)



Pre-insulated (Coil)

Vorgeïsoleerd (Rol)

Pré-isolé (Rouleau)

Isoliert (Ring)

Article number	m / Pallet	Type	Pallet dimension
100-ISO4-14-RO	100 m / 1000 m	14x2 red	75x75 cm
100-ISO4-14-BL	100 m / 1000 m	14x2 blue	75x75 cm
100-ISO4-16-RO	100 m / 1300 m	16x2 red	75x75 cm
100-ISO4-16-BL	100 m / 1300 m	16x2 blue	75x75 cm
50-ISO4-18-RO	50 m / 650 m	18x2 red	75x75 cm
50-ISO4-18-BL	50 m / 650 m	18x2 blue	75x75 cm
50-ISO4-20-RO	50 m / 700 m	20x2 red	75x75 cm
50-ISO4-20-BL	50 m / 700 m	20x2 blue	75x75 cm
100-ISO4-20-RO	100 m / 700 m	20x2 red	75x75 cm
100-ISO4-20-BL	100 m / 700 m	20x2 blue	75x75 cm
25-ISO4-26-RO	25 m / 300 m	26x3 red	75x75 cm
25-ISO4-26-BL	25 m / 300 m	26x3 blue	75x75 cm
50-ISO4-26-RO	50 m / 500 m	26x3 red	75x75 cm
50-ISO4-26-BL	50 m / 500 m	26x3 blue	75x75 cm
25-ISO4-32-RO	25 m / 300 m	32x3 red	75x75 cm
25-ISO4-32-BL	25 m / 300 m	32x3 blue	75x75 cm

## A. STANDARD (PE-Xc/AL/PE-Xc)



### Type: ISO9 (10 mm)



Pre-insulated (Coil)  
Voorgeïsoleerd (Rol)  
Pré-isolé (Rouleau)  
Isoliert (Ring)

Article number	m / Pallet	Type	Pallet dimension
50-ISO9-14-RO	50 m / 550 m	14x2 red	75x75 cm
50-ISO9-14-BL	50 m / 550 m	14x2 blue	75x75 cm
50-ISO9-16-RO	50 m / 550 m	16x2 red	75x75 cm
50-ISO9-16-BL	50 m / 550 m	16x2 blue	75x75 cm
50-ISO9-18-RO	50 m / 500 m	18x2 red	75x75 cm
50-ISO9-18-BL	50 m / 500 m	18x2 blue	75x75 cm
50-ISO9-20-RO	50 m / 500 m	20x2 red	75x75 cm
50-ISO9-20-BL	50 m / 500 m	20x2 blue	75x75 cm
25-ISO9-26-RO	25 m / 275 m	26x3 red	75x75 cm
25-ISO9-26-BL	25 m / 275 m	26x3 blue	75x75 cm
50-ISO9-26-RO	50 m / 450 m	26x3 red	75x75 cm
50-ISO9-26-BL	50 m / 450 m	26x3 blue	75x75 cm
25-ISO9-32-RO	25 m / 250 m	32x3 red	75x75 cm
25-ISO9-32-BL	25 m / 250 m	32x3 blue	75x75 cm

### Type: ISO13 (13 mm)



Pre-insulated (Coil)  
Voorgeïsoleerd (Rol)  
Pré-isolé (Rouleau)  
Isoliert (Ring)

Article number	m / Pallet	Type	Pallet dimension
50-ISO13-16-BL	50 m / 400 m	16x2 blue	75x75 cm
50-ISO13-18-BL	50 m / 400 m	18x2 blue	75x75 cm
50-ISO13-20-BL	50 m / 400 m	20x2 blue	75x75 cm
50-ISO13-26-BL	50 m / 400 m	26x3 blue	75x75 cm
25-ISO13-32-BL	25 m / 200 m	32x3 blue	75x75 cm

## A. STANDARD (PE-Xc/AL/PE-Xc)

### 1 Type: COMBI ISO



Henco Combi iso 6 mm (Coil)  
 Henco Combi iso 6mm (Rol)  
 Henco Combi iso 6mm (Rouleau)  
 Henco Combi iso 6mm (Ring)

Article number	m / Pallet	Type	Pallet dimension
50-ISO4-COMBI16	50 m / 400 m	16x2	80x80 cm

### 2 Type: STANDARD PIPE IN PIPE



With colour coded conduit (Coil)  
 Met mantel (Rol)  
 Avec gaine (Rouleau)  
 Mit Mantel (Ring)

Article number	m / Pallet	Type	Pallet dimension
25-014MR	25 m / 500 m	14x2 red	120x80 cm
25-014MB	25 m / 500 m	14x2 blue	120x80 cm
50-014MR	50 m / 800 m	14x2 red	120x80 cm
50-014MB	50 m / 800 m	14x2 blue	120x80 cm
50-014MBLACK	50 m / 800 m	14x2 black	120x80 cm
100-014MR	100 m / 1000 m	14x2 red	120x80 cm
100-014MB	100 m / 1000 m	14x2 blue	120x80 cm
100-014MBLACK	100 m / 1000 m	14x2 black	120x80 cm
25-016MR	25 m / 500 m	16x2 red	120x80 cm
25-016MB	25 m / 500 m	16x2 blue	120x80 cm
50-016MR	50 m / 800 m	16x2 red	120x80 cm
50-016MB	50 m / 800 m	16x2 blue	120x80 cm
50-016MBLACK	50 m / 800 m	16x2 black	120x80 cm
100-016MR	100 m / 1000 m	16x2 red	120x80 cm
100-016MB	100 m / 1000 m	16x2 blue	120x80 cm
100-016MBLACK	100 m / 1000 m	16x2 black	120x80 cm
50-018MR	50 m / 800 m	18x2 red	120x80 cm
50-018MB	50 m / 800 m	18x2 blue	120x80 cm
100-018MR	100 m / 1000 m	18x2 red	120x80 cm
100-018MB	100 m / 1000 m	18x2 blue	120x80 cm
25-020MR	25 m / 500 m	20x2 red	120x80 cm
25-020MB	25 m / 500 m	20x2 blue	120x80 cm
25-020MBLACK	25 m / 500 m	20x2 black	120x80 cm
50-020MR	50 m / 800 m	20x2 red	120x80 cm
50-020MB	50 m / 800 m	20x2 blue	120x80 cm
50-020MBLACK	50 m / 800 m	20x2 black	120x80 cm
100-020MB	100 m / 1000 m	20x2 blue	120x80 cm
100-020MR	100 m / 1000 m	20x2 red	120x80 cm
25-026MR	25 m / 500 m	26x3 red	120x80 cm
25-026MB	25 m / 500 m	26x3 blue	120x80 cm
50-026MR	50 m / 500 m	26x3 red	120x80 cm
50-026MB	50 m / 500 m	26x3 blue	120x80 cm
50-026MBLACK	50 m / 500 m	26x3 black	120x80 cm
25-032MR	25 m / 300 m	32x3 red	120x80 cm
25-032MB	25 m / 300 m	32x3 blue	120x80 cm





## Type: COMBI STANDARD



Henco Combi (Coil)  
 Henco Combi (Rol)  
 Henco Combi (Rouleau)  
 Henco Combi (Ring)

Article number	m / Pallet	Type	Pallet dimension
50-COMBI16	50 m / 800 m	16x2	120x80 cm

- 1
- 2
- 3
- 4
- 5
- 6
- 7
- 8
- 9
- 10
- 11

## Type: FLEX STANDARD



Henco Flex (Coil)  
 Henco Flex (Rol)  
 Henco Flex (Rouleau)  
 Henco Flex (Ring)

Article number	Packing	Type
100-FLEX26	100 m	2 - 26x3 (OD90)
100-FLEX32	100 m	2 - 32x3 (OD125)

*TILL EXHAUSTION OF STOCK*

## A. STANDARD (PE-Xc/AL/PE-Xc)

### 1 Type: STANDARD PIPE IN PIPE CSC



With colour coded conduit (Coil Small Core)

Met mantel (Rol Kleine Kern)

Avec gaine (Petit Rouleau Noyau intérieure)

Mit Mantel (Ring kleinen Kern)

Article number	Pallet	Type	Pallet dimension
25-016MB-KB	25 m / 600 m	16x2	120x80 cm
25-016MR-KB	25 m / 600 m	16x2	120x80 cm

*ID Coil: 28cm*

### 9 Type: LB



Henco carcassing pipe Ø 16

Dubbele radiatorbocht Henco buis Ø 16, doorverbonden einde

Double courbe radiateur, tube Henco Ø 16, embout fermé

Heizkörperwinkel doppelt, Henco Rohr Ø 16, durchgestellt Ende

Article number	m	Type
LB50	1 m	50 mm



## Type: ISO-BLOCK-S



Henco carcassing pipe Ø 16 with insulation  
 Dubbele radiator aansluitbocht met isolatie, Ø 16, doorverbonden einde  
 Double courbe radiateur, Ø 16, avec isolation, embout fermé  
 Heizkörperwinkel doppelt mit Isolation, Ø 16, durchgestellt Ende

Article number	m	Type
ISO-BLOCK-S	1 m	ISO-BLOCK-S

## Type: ISO-BLOCK-XL



Henco carcassing pipe Ø 16 with insulation  
 Dubbele radiator aansluitbocht met isolatie, Ø 16, doorverbonden einde  
 Double courbe radiateur, Ø 16, avec isolation, embout fermé  
 Heizkörperwinkel doppelt mit Isolation, Ø 16, durchgestellt Ende

Article number	m	Type
ISO-BLOCK-XL	1 m	ISO-BLOCK-XL

*TILL EXHAUSTION OF STOCK*

- 1
- 2
- 3
- 4
- 5
- 6
- 7
- 8
- 9
- 10
- 11

## A. STANDARD (PE-Xc/AL/PE-Xc)

### Type: COIL



Henco multilayer pipe RIXc (Coil)  
 Henco meerlagenbuis RIXc (Rol)  
 Henco tube multicouche RIXc (Rouleau)  
 Henco Merschichtverbundrohr RIXc (Ring)

Article number	m / Pallet	Type	Pallet dimension
50-R160212	50 m / 1500 m	16x2	160x80 cm
100-R160212	100 m / 2200 m	16x2	75x75 cm
200-R160212	200 m / 2600 m	16x2	75x75 cm
500-R160212D	500 m / 2500 m	16x2	75x75 cm
100-R180214	100 m / 1700 m	18x2	75x75 cm
200-R180214	200 m / 2000 m	18x2	75x75 cm
100-R200216	100 m / 1500 m	20x2	75x75 cm
50-R260320	50 m / 800 m	26x3	75x75 cm

### Type: COIL CSC



Henco multilayer pipe RIXc (Coil Small Core)  
 Henco meerlagenbuis RIXc (Rol Kleine Kern)  
 Henco tube multicouche RIXc (Rouleau Petit Noyau)  
 Henco Merschichtverbundrohr RIXc (Ring kleinen Kern)

Article number	Pallet	Type	Pallet dimension
10-R160212-KB	10 m / 800 m	16x2	120x80 cm
15-R160212-KB	15 m / 900 m	16x2	120x80 cm
25-R160212-KB	25 m / 1125 m	16x2	120x80 cm

*ID Coil: 28cm*

### Type: STRAIGHT LENGTH



Henco multilayer pipe RIXc (Straight length)  
 Henco meerlagenbuis RIXc (Stang)  
 Henco tube multicouche RIXc (Barre)  
 Henco Merschichtverbundrohr RIXc (Stange)

Article number	Cylinder	Type	Pallet dimension
03-R160212	75 m / 3600 m	16x2	310x75 cm
04-R160212	100 m / 4800 m	16x2	410x75 cm
05-R160212	125 m / 6000 m	16x2	510x75 cm
03-R200216	54 m / 2592 m	20x2	310x75 cm
04-R200216	72 m / 3456 m	20x2	410x75 cm
05-R200216	90 m / 4320 m	20x2	510x75 cm
03-R260320	30 m / 1440 m	26x3	310x75 cm
04-R260320	40 m / 1920 m	26x3	410x75 cm
05-R260320	50 m / 2400 m	26x3	510x75 cm

## A. STANDARD (PE-Xc/AL/PE-Xc)



### Type: ISO4 (6 mm)



RIXc Pre-insulated (Coil)  
 RIXc Voorgeïsoleerd (Rol)  
 RIXc Pré-isolé (Rouleau)  
 RIXc Isoliert (Ring)

Article number	m / Pallet	Typ	Pallet dimension
100-ISO4-R16-RO	100 m / 1300 m	16x2 red	75x75 cm
100-ISO4-R16-BL	100 m / 1300 m	16x2 blue	75x75 cm
50-ISO4-R18-RO	50 m / 650 m	18x2 red	75x75 cm
50-ISO4-R18-BL	50 m / 650 m	18x2 blue	75x75 cm
50-ISO4-R20-RO	50 m / 700 m	20x2 red	75x75 cm
50-ISO4-R20-BL	50 m / 700 m	20x2 blue	75x75 cm
25-ISO4-R26-RO	25 m / 300 m	26x3 red	75x75 cm
25-ISO4-R26-BL	25 m / 300 m	26x3 blue	75x75 cm
50-ISO4-R26-RO	50 m / 500 m	26x3 red	75x75 cm
50-ISO4-R26-BL	50 m / 500 m	26x3 blue	75x75 cm

### Type: ISO9 (10 mm)



RIXc Pre-insulated (Coil)  
 RIXc Voorgeïsoleerd (Rol)  
 RIXc Pré-isolé (Rouleau)  
 RIXc Isoliert (Ring)

Article number	m / Pallet	Typ	Pallet dimension
50-ISO9-R16-RO	50 m / 550 m	16x2 red	75x75 cm
50-ISO9-R16-BL	50 m / 550 m	16x2 blue	75x75 cm
50-ISO9-R18-BL	50 m / 650 m	18x2 blue	75x75 cm
50-ISO9-R20-RO	50 m / 500 m	20x2 red	75x75 cm
50-ISO9-R20-BL	50 m / 500 m	20x2 blue	75x75 cm
25-ISO9-R26-RO	25 m / 275 m	26x3 red	75x75 cm
25-ISO9-R26-BL	25 m / 275 m	26x3 blue	75x75 cm

### Type: ISO13 (13 mm)



RIXc Pre-insulated (Coil)  
 RIXc Voorgeïsoleerd (Rol)  
 RIXc Pré-isolé (Rouleau)  
 RIXc Isoliert (Ring)

Article number	m / Pallet	Typ	Pallet dimension
50-ISO13-R16-BL	50 m / 500 m	16x2 blue	75x75 cm
50-ISO13-R20-BL	50 m / 400 m	20x2 blue	75x75 cm
50-ISO13-R26-BL	50 m / 400 m	26x3 blue	75x75 cm

1

2

3

4

5

6

7

8

9

10

11

## B. RIXc (PE-Xc/AL/PE-Xc)

### 1 Type: COMBI ISO RIXc



Henco Combi iso 6 mm (Coil)  
 Henco Combi iso 6mm (Rol)  
 Henco Combi iso 6mm (Rouleau)  
 Henco Combi iso 6mm (Ring)

Article number	m / Pallet	Type	Pallet dimension
50-ISO4-COMBI16R	50 m / 400 m	16x2	75x75 cm

### 8 Type: RIXc PIPE IN PIPE



RIXc With colour coded conduit (Coil)  
 RIXc Met mantel (Rol)  
 RIXc Avec gaine (Rouleau)  
 RIXc Mit Mantel (Ring)

Article number	m / Pallet	Type	Pallet dimension
25-R16MR	25 m / 500 m	16x2 red	120x80 cm
25-R16MB	25 m / 500 m	16x2 blue	120x80 cm
50-R16MR	50 m / 1000 m	16x2 red	120x80 cm
50-R16MB	50 m / 1000 m	16x2 blue	120x80 cm
50-R16MBLACK	50 m / 1000 m	16x2 black	120x80 cm
100-R16MR	100 m / 1000 m	16x2 red	120x80 cm
100-R16MB	100 m / 1000 m	16x2 blue	120x80 cm
100-R16MBLACK	100 m / 1000 m	16x2 black	120x80 cm
50-R18MR	50 m / 800 m	18x2 red	120x80 cm
50-R18MB	50 m / 800 m	18x2 blue	120x80 cm
25-R20MR	25 m / 500 m	20x2 red	120x80 cm
25-R20MB	25 m / 500 m	20x2 blue	120x80 cm
25-R20MBLACK	25 m / 500 m	20x2 black	120x80 cm
50-R20MR	50 m / 800 m	20x2 red	120x80 cm
50-R20MB	50 m / 800 m	20x2 blue	120x80 cm
100-R20MR	100 m / 1000 m	20x2 red	120x80 cm
100-R20MB	100 m / 1000 m	20x2 blue	120x80 cm
50-R26MR	50 m / 500 m	26x3 red	120x80 cm
50-R26MB	50 m / 500 m	26x3 blue	120x80 cm

### Type: COMBI RIXc



Henco Combi (Coil)  
 Henco Combi (Rol)  
 Henco Combi (Rouleau)  
 Henco Combi (Ring)

Article number	m / Pallet	Type	Pallet dimension
50-COMBI16R	50 m / 800 m	16x2	120x80 cm



### Type: FLOOR-RIXc



Henco multilayer pipe (Coil)

Henco meerlagenbuis (Rol)

Henco tube multicouche (Rouleau)

Henco Mehrschichtverbundrohr (Ring)

Article number	m / Pallet	Type	Pallet dimension
100-F16R-WZ	100 m / 2200 m	16x2	75x75 cm
200-F16R-WZ	200 m / 2600 m	16x2	80x80 cm
500-F16R-WZ	500 m / 2500 m	16x2	75x75 cm
100-F20R-WZ	100 m / 1000 m	20x2	75x75 cm
200-F20R-WZ	200 m / 1000 m	20x2	75x75 cm
400-F20R-WZ	400 m / 1200 m	20x2	75x75 cm

6 bar - 60°C

1

2

3

4

5

6

7

8

9

10

11



## D. PE-Xc

- 1
- 2
- 3
- 4
- 5
- 6
- 7
- 8
- 9
- 10
- 11

### Type: 5L PE-Xc



Henco 5L PE-Xc pipe PE-Xc/EVOH/PE-Xc (Coil)

Henco 5L PE-Xc buis PE-Xc/EVOH/PE-Xc (Rol)

Henco 5L PE-Xc tube PE-Xc/EVOH/PE-Xc (Rouleau)

Henco 5L PE-Xc Rohr PE-Xc/EVOH/PE-Xc (Ring)

Article number	m / Pallet	Type	Pallet dimension
200-PXC1620	200 m / 1600 m	16x2	75x75 cm
600-PXC1620	600 m / 2400 m	16x2	80x80 cm
200-PXC1720	200 m / 2000 m	17x2	80x80 cm
600-PXC1720	600 m / 2400 m	17x2	80x80 cm
240-PXC1820	240 m / 2160 m	18x2	80x80 cm
200-PXC2020	200 m / 1000 m	20x2	75x75 cm
600-PXC2020	600 m / 1200 m	20x2	





## Type: 5L PE-RT



**Henco 5L PE-RT pipe PE-RT/EVOH/PE-RT (Coil)**

**Henco 5L PE-RT buis PE-RT/EVOH/PE-RT (Rol)**

**Henco 5L PE-RT tube PE-RT/EVOH/PE-RT (Rouleau)**

**Henco 5L PE-RT Rohr PE-RT/EVOH/PE-RT (Ring)**

Article number	m / Pallet	Type	Pallet dimension
120-PRT1620	120 m / 1440 m	16x2	80x80 cm
200-PRT1620	200 m / 1600 m	16x2	80x80 cm
200-PRT1820	200 m / 2000 m	18x2	80x80 cm
600-PRT1620	600 m / 2400 m	16x2	80x80 cm
600-PRT1720	600 m / 2400 m	17x2	80x80 cm
600-PRT1820	600 m / 1200 m	18x2	80x80 cm
600-PRT2020	600 m / 1800 m	20x2	80x80 cm

1

2

3

4

5

6

7

8

9

10

11

## F. PROTECTION HOSE

### 1 Type: PROTECTION HOSE



Colour coded conduit (Coil)

Mantel (Rol)

Gaine (Rouleau)

Mantel (Ring)

Article number	m / Pallet	Type	Pallet dimension
100-MR	100 m / 2400 m	Ø14/Ø16/Ø18	120x80 cm
100-MB	100 m / 2400 m	Ø14/Ø16/Ø18 blue	120x80 cm
50-MR20	50 m / 1800 m	Ø20 red	120x80 cm
50-MB20	50 m / 1800 m	Ø20 blue	120x80 cm
50-MR26	50 m / 1200 m	Ø26 red	120x80 cm
50-MB26	50 m / 1200 m	Ø26 blue	120x80 cm
25-MR32	25 m / 1000 m	Ø32 red	120x80 cm
25-MB32	25 m / 1000 m	Ø32 blue	120x80 cm
100-MBLACK	100 m / 2400 m	Ø14/Ø16/Ø18 black	120x80 cm
50-MBLACK20	50 m / 1800 m	Ø20 black	120x80 cm
50-MBLACK26	50 m / 1200 m	Ø26 black	120x80 cm

### 11 Type: PROTECTION HOSE GAS



Colour coded conduit (Coil)

Mantel (Rol)

Gaine (Rouleau)

Mantel (Ring)

Article number	m / Pallet	Type	Pallet dimension
50-MG16	50 m / 2400 m	Ø16 yellow	120x80 cm
100-MG16	100 m / 2400 m	Ø16 yellow	120x80 cm
50-MG20	50 m / 1800 m	Ø20 yellow	120x80 cm
50-MG26	50 m / 1200 m	Ø26 yellow	120x80 cm
25-MG32	25 m / 1000 m	Ø32 yellow	120x80 cm

## G. GAS STANDARD (PE-Xc/AL/PE-Xc)



Gas: only allowed in countries where has been a HENCO GAS testing + certificate is available! (see [www.henco.be](http://www.henco.be))  
 Gas: enkel toegelaten in landen waar er een HENCO GAS keur is + een certificaat voorhanden is! (zie [www.henco.be](http://www.henco.be))  
 Gaz: seulement permis dans des pays où le contrôle a eu lieu + certificat est disponible! (Consultez [www.henco.be](http://www.henco.be))  
 Gas: nur zugelassen in Länder wo HENCO GAS Prüfung geschehen ist + Zertifikat vorhanden ist! (Siehe [www.henco.be](http://www.henco.be))

### Type: COIL



Henco multilayer pipe (Coil)  
 Henco Meerlagenbuis (Rol)  
 Henco tube multicouche (Rouleau)  
 Henco Mehrschichtverbundrohr (Ring)

Article number	m / Pallet	Type	Pallet dimension
25-160212-GAS	25 m / 800 m	16x2	75x75 cm
50-160212-GAS	50 m / 1500 m	16x2	120x80 cm
25-200216-GAS	25 m / 800 m	20x2	75x75 cm
50-200216-GAS	50 m / 1000 m	20x2	120x80 cm
50-260320-GAS	50 m / 800 m	26x3	75x75 cm
50-320326-GAS	50 m / 650 m	32x3	90x90 cm

### Type: STRAIGHT LENGTH



Henco multilayer pipe (Straight length)  
 Henco Meerlagenbuis (Stang)  
 Henco tube multicouche (Barre)  
 Henco Mehrschichtverbundrohr (Stange)

Article number	Cylinder / Pallet	Type	Pallet dimension
05-160212-GAS	125 m / 6000 m	16x2	510x70,5 cm
05-200216-GAS	90 m / 4300 m	20x2	510x70,5 cm
05-260320-GAS	50 m / 2400 m	26x3	510x70,5 cm
05-320326-GAS	35 m / 1680 m	32x3	510x70,5 cm
05-403533-GAS	45 m / 1080 m	40x3,5	510x70,5 cm

### Type: GAS PIPE IN PIPE



With colour coded conduit (Coil)  
 Met mantel (Rol)  
 Avec gaine (Rouleau)  
 Mit Mantel (Ring)

Article number	m / Pallet	Typ	Pallet dimension
25-016GASMG	25 m / 500 m	16x2	120x80 cm
50-016GASMG	50 m / 500 m	16x2	120x80 cm
25-020GASMG	25 m / 500 m	20x2	120x80 cm
50-020GASMG	50 m / 800 m	20x2	120x80 cm
50-026GASMG	50 m / 500 m	26x3	120x80 cm
25-032GASMG	25 m / 300 m	32x3	120x80 cm

Gastec: Standard pipe gas in combination with Henco press fittings PVDF for gas, see page 43

DVGW and Kiwa Uni: Standard pipe gas in combination with Henco brass press fittings for gas, see page 85





## H. SPRINKLER

### 1 Type: COIL



Henco multilayer pipe (Coil)  
 Henco Meerlagenbuis (Rol)  
 Henco tube multicouche (Rouleau)  
 Henco Mehrschichtverbundrohr (Ring)

Article number	m / Pallet	Type	Pallet dimension
50-260320-SPR	30 m / 1440 m	26 x 3	310x70,5 cm
50-320326-SPR	40 m / 1920 m	32 x 3	410x70,5 cm

### 7 Type: Straight length



Henco multilayer pipe (Straight length)  
 Henco meerlagenbuis (stang)  
 Henco tube multicouche (Barre)  
 Hanco Merhschichtverbundrohr (Stange)

Article number	m / Pallet	Type	Pallet dimension
05-260320-SPR	50 m / 2400 m	26 x 3	510x70,5 cm
05-320326-SPR	35 m / 1680 m	32 x 3	510x70,5 cm
05-403533-SPR	45 m / 1080 m	40 x 3,5	510x70,5 cm
05-504042-SPR	35 m / 840 m	50 x 4	510x70,5 cm
05-634554-SPR	20 m / 480 m	63 x 4,5	510x70,5 cm

Standard pipe Sprinkler in combination with Henco press fittings PVDF for Sprinkler, see page 47





	<i>Page</i>
<i>A. PK</i>	<i>22</i>
<i>B. PKW</i>	<i>35</i>
<i>C. PKG</i>	<i>42</i>
<i>E. PKS</i>	<i>47</i>
<i>D. SUPER SIZES</i>	<i>53</i>
<i>F. ECOLINE</i>	<i>59</i>

## Type: 1PK



Elbow 90°

Knie 90°

Coude 90°

Winkel 90°

Article number	Bag / Box	Type
1PK-1414	10 pc. / 150 pc.	14x14
1PK-1616	10 pc. / 120 pc.	16x16
1PK-1818	10 pc. / 100 pc.	18x18
1PK-2020	10 pc. / 80 pc.	20x20
1PK-2626	5 pc. / 50 pc.	26x26
1PK-3232	5 pc. / 30 pc.	32x32
1PK-4040	5 pc. / 20 pc.	40x40
1PK-5050	1 pc. / 8 pc.	50x50
1PK-6363	1 pc. / 6 pc.	63x63
1PK-7575	See page 51	75x75
1PK-9090	See page 51	90x90

## Type: 1PK-JG



Elbow 90° 16x10JG (ceiling cooling)

Knie 90° 16x10JG (koelplafond)

Coude 90° 16x10JG (plafond climatisé)

Winkel 90° 16x10JG (Klimaatplafond)

Article number	Bag / Box	Type
1PK-16JG10	10 pc. / 120 pc.	16x10JG
1PK-20JG10	10 pc. / 100 pc.	20x10JG

## Type: 2PK



Backplate elbow female

Sanitair muurplaat binnendraad

Culasse pour sanitaire

Sanitär Wandscheibe IG

Article number	Bag / Box	Type
2PK-1404BP*	10 pc. / 50 pc.	14x1/2" (56 mm)
2PK-1603	10 pc. / 50 pc.	16x3/8" (56 mm)
2PK-1604BP*	10 pc. / 50 pc.	16x1/2" (56 mm)
2PK-1804BP*	10 pc. / 50 pc.	18x1/2" (56 mm)
2PK-2004BP*	10 pc. / 50 pc.	20x1/2" (56 mm)
2PK-2005	5 pc. / 30 pc.	20x3/4" (56 mm)
2PK-2605	5 pc. / 30 pc.	26x3/4" (56 mm)

\* With black plug BP04 1/2"

Accessory 2PK: galvanised bracket plate - see page 168



PLP-P-PK



PLF-P-PK



## Type: 2PK-K



**Backplate elbow female, short model**  
**Sanitair muurplaat binnendraad, laag**  
**Culasse pour sanitaire, modèle court**  
**Sanitär Wandscheibe IG, kurzes Modell**

Article number	Bag / Box	Type
2PK-1604KBP*	10 pc. / 50 pc.	16x1/2" (40 mm)

*\* With black plug BP04 1/2"*

Accessory 2PK-K: galvanised bracket plate - see page 168



PLP-P-PK



PLF-P-PK

## Type: 3PK



**Double backplate elbow female, short model**  
**Sanitair muurplaat binnendraad dubbel, laag**  
**Culasse double pour sanitaire, modèle court**  
**Sanitär Wandscheibe doppelt IG, kurzes Modell**

Article number	Bag / Box	Type
3PK-160416BP*	10 pc. / 30 pc.	16x1/2"x16 (40 mm)
3PK-200420BP*	10 pc. / 30 pc.	20x1/2"x20 (40 mm)

*\* With black plug BP04 1/2"*

## Type: BP04



**Black plug for 1/2" female nipple**  
**Zwarte stop voor 1/2"**  
**Bouchon noir pour 1/2" nipple femelle**  
**Schwarzen Stopf für 1/2" Nippel**

Article number	Bag / Box	Type
BP04	50 pc. / 500 pc.	1/2"

- 1
- 2
- 3
- 4
- 5
- 6
- 7
- 8
- 9
- 10
- 11

## Type: 5PK (CW617)



PK-TOOL p 170

**Bend 90° male adapter**

**Knie 90° buitendraad**

**Coude 90° mâle**

**Winkel 90° AG**

Article number	Bag / Box	Type
5PK-1404	10 pc. / 60 pc.	14x1/2"
5PK-1604	10 pc. / 60 pc.	16x1/2"
5PK-1804	10 pc. / 60 pc.	18x1/2"
5PK-2004	10 pc. / 60 pc.	20x1/2"
5PK-2005	10 pc. / 50 pc.	20x3/4"
5PK-2605	10 pc. / 40 pc.	26x3/4"
5PK-3206	5 pc. / 20 pc.	32x1"
5PK-4007	3 pc. / 15 pc.	40x1 1/4"
5PK-5007	1 pc. / 10 pc.	50x1 1/4"
5PK-5008	1 pc. / 8 pc.	50x1 1/2"
5PK-6310	1 pc. / 4 pc.	63x2"
5PK-7510	See page 51	75x2"
5PK-7512	See page 51	75x2 1/2"

## Type: 5PK-N (CW602)



PK-TOOL p 170

**Bend 90° male adapter**

**Knie 90° buitendraad**

**Coude 90° mâle**

**Winkel 90° AG**

Article number	Bag / Box	Type
5PK-4007-N	3 pc. / 15 pc.	40x1 1/4"
5PK-5007-N	1 pc. / 10 pc.	50x1 1/4"
5PK-5008-N	1 pc. / 8 pc.	50x1 1/2"
5PK-6310-N	1 pc. / 4 pc.	63x2"

## Type: 6PK (CW617)



PK-TOOL p 170

**Bend 90° female adapter**

**Knie 90° binnendraad**

**Coude 90° femelle**

**Winkel 90° IG**

Article number	Bag / Box	Type
6PK-1404BP*	10 pc. / 60 pc.	14x1/2"
6PK-1603	10 pc. / 60 pc.	16x3/8"
6PK-1604BP*	10 pc. / 60 pc.	16x1/2"
6PK-1804BP*	10 pc. / 60 pc.	18x1/2"
6PK-2004BP*	10 pc. / 60 pc.	20x1/2"
6PK-2005	10 pc. / 50 pc.	20x3/4"
6PK-2605	10 pc. / 50 pc.	26x3/4"
6PK-3206	5 pc. / 20 pc.	32x1"
6PK-4007	5 pc. / 15 pc.	40x1 1/4"
6PK-5007	1 pc. / 8 pc.	50x1 1/4"
6PK-5008	1 pc. / 8 pc.	50x1 1/2"
6PK-6310	1 pc. / 4 pc.	63x2"
6PK-7506	See page 51	75x1"
6PK-7510	See page 51	75x2"
6PK-7512	See page 51	75x2 1/2"
6PK-9014	See page 51	90x3"





## Type: 6PK-N (CW602)



PK-TOOL p 170

**Bend 90° female adapter**  
**Knie 90° binnendraad**  
**Coude 90° femelle**  
**Winkel 90° IG**

Article number	Bag / Box	Type
6PK-4007-N	5 pc. / 15 pc.	40x1 1/4"
6PK-5007-N	1 pc. / 8 pc.	50x1 1/4"
6PK-5008-N	1 pc. / 8 pc.	50x1 1/2"
6PK-6310-N	1 pc. / 4 pc.	63x2"

## Type: 9PK



**T-piece**  
**T-stuk**  
**Pièce en T**  
**T-Stück**

Article number	Bag / Box	Type
9PK-141414	10 pc. / 100 pc.	14x14x14
9PK-161616	10 pc. / 60 pc.	16x16x16
9PK-181818	10 pc. / 60 pc.	18x18x18
9PK-202020	10 pc. / 50 pc.	20x20x20
9PK-262626	5 pc. / 30 pc.	26x26x26
9PK-323232	5 pc. / 15 pc.	32x32x32
9PK-404040	5 pc. / 10 pc.	40x40x40
9PK-505050	1 pc. / 6 pc.	50x50x50
9PK-636363	1 pc. / 3 pc.	63x63x63
9PK-757575	See page 51	75x75x75
9PK-909090	See page 51	90x90x90

- 1
- 2
- 3
- 4
- 5
- 6
- 7
- 8
- 9
- 10
- 11

## Type: 10PK



T-reduced centre

T-verlopend

Pièce en T-réduit

T-reduziert

Article number	Bag / Box	Type
10PK-161416	10 pc. / 50 pc.	16x14x16
10PK-181418	10 pc. / 50 pc.	18x14x18
10PK-181618	10 pc. / 50 pc.	18x16x18
10PK-201420	10 pc. / 50 pc.	20x14x20
10PK-201620	10 pc. / 50 pc.	20x16x20
10PK-201820	10 pc. / 50 pc.	20x18x20
10PK-261626	5 pc. / 30 pc.	26x16x26
10PK-261826	5 pc. / 30 pc.	26x18x26
10PK-262026	5 pc. / 30 pc.	26x20x26
10PK-321632	5 pc. / 25 pc.	32x16x32
10PK-321832	5 pc. / 25 pc.	32x18x32
10PK-322032	5 pc. / 25 pc.	32x20x32
10PK-322632	5 pc. / 20 pc.	32x26x32
10PK-401640	5 pc. / 15 pc.	40x16x40
10PK-402040	5 pc. / 15 pc.	40x20x40
10PK-402640	5 pc. / 15 pc.	40x26x40
10PK-403240	5 pc. / 10 pc.	40x32x40
10PK-502050	1 pc. / 6 pc.	50x20x50
10PK-502650	1 pc. / 8 pc.	50x26x50
10PK-503250	1 pc. / 8 pc.	50x32x50
10PK-504050	1 pc. / 6 pc.	50x40x50
10PK-632663	1 pc. / 4 pc.	63x26x63
10PK-633263	1 pc. / 3 pc.	63x32x63
10PK-634063	1 pc. / 3 pc.	63x40x63
10PK-635063	1 pc. / 3 pc.	63x50x63
10PK-753275	See page 51	75x32x75
10PK-754075	See page 51	75x40x75
10PK-755075	See page 51	75x50x75
10PK-756375	See page 51	75x63x75
10PK-903290	See page 51	90x32x90
10PK-904090	See page 51	90x40x90
10PK-905090	See page 51	90x50x90
10PK-906390	See page 51	90x63x90
10PK-907590	See page 51	90x75x90

## Type: 10PK-JG



T-reduced centre 16x10JGx16 (ceiling cooling)

T-verlopend 16x10JGx16 (koelplafond)

Pièce en T-réduit 16x10JGx16 (plafond climatisé)

T-reduziert 16x10JGx16 (Klimaatplafond)

Article number	Bag / Box	Type
10PK-16JG1016	10 pc. / 50 pc.	16x10JGx16
10PK-20JG1020	10 pc. / 50 pc.	20x10JGx20



Type: 11PK



## T-branch and line reduced

T-2X verlopemd

Pièce en T 2X réduit

T-2X reduziert

Article number	Bag / Box	Type
11PK-161414	10 pc. / 50 pc.	16x14x14
11PK-181616	10 pc. / 50 pc.	18x16x16
11PK-201616	10 pc. / 50 pc.	20x16x16
11PK-201818	10 pc. / 50 pc.	20x18x18
11PK-202016	10 pc. / 50 pc.	20x20x16
11PK-261616	10 pc. / 50 pc.	26x16x16
11PK-261620	5 pc. / 30 pc.	26x16x20
11PK-262016	5 pc. / 30 pc.	26x20x16
11PK-262020	5 pc. / 30 pc.	26x20x20
11PK-262616	5 pc. / 30 pc.	26x26x16
11PK-262620	5 pc. / 30 pc.	26x26x20
11PK-322026	5 pc. / 20 pc.	32x20x26
11PK-322626	5 pc. / 20 pc.	32x26x26
11PK-402032	5 pc. / 15 pc.	40x20x32
11PK-402632	5 pc. / 15 pc.	40x26x32
11PK-403232	5 pc. / 10 pc.	40x32x32
11PK-404026	5 pc. / 10 pc.	40x40x26
11PK-404032	5 pc. / 10 pc.	40x40x32
11PK-502040	1 pc. / 10 pc.	50x20x40
11PK-502640	1 pc. / 10 pc.	50x26x40
11PK-503240	1 pc. / 10 pc.	50x32x40
11PK-504040	1 pc. / 8 pc.	50x40x40
11PK-753232	See page 51	75x32x32
11PK-753240	See page 51	75x32x40
11PK-753250	See page 51	75x32x50
11PK-753263	See page 51	75x32x63
11PK-753275	See page 51	75x32x75
11PK-754040	See page 51	75x40x40
11PK-754050	See page 51	75x40x50
11PK-754063	See page 51	75x40x63
11PK-755050	See page 51	75x50x50
11PK-755063	See page 51	75x50x63
11PK-756363	See page 51	75x63x63
11PK-903232	See page 51	90x32x32
11PK-903240	See page 51	90x32x40
11PK-903250	See page 51	90x32x50
11PK-903263	See page 51	90x32x63
11PK-903275	See page 51	90x32x75
11PK-903290	See page 51	90x32x90
11PK-904040	See page 51	90x40x40
11PK-904050	See page 51	90x40x50
11PK-904063	See page 51	90x40x63
11PK-904075	See page 51	90x40x75
11PK-905050	See page 51	90x50x50
11PK-905063	See page 51	90x50x63
11PK-905075	See page 51	90x50x75
11PK-906363	See page 51	90x63x63
11PK-906375	See page 51	90x63x75
11PK-907575	See page 51	90x75x75

1

2

3

4

5

6

7

8

9

10

11

## Type: 12PK



T-enlarged branch

T-vergroot

Pièce en T agrandi

T-erweitert

Article number	Bag / Box	Type
12PK-161816	10 pc. / 50 pc.	16x18x16
12PK-162016	10 pc. / 50 pc.	16x20x16
12PK-202620	5 pc. / 30 pc.	20x26x20
12PK-263226	5 pc. / 20 pc.	26x32x26
12PK-324032	5 pc. / 15 pc.	32x40x32
12PK-327532	See page 51	32x75x32
12PK-329032	See page 51	32x90x32
12PK-405040	1 pc. / 8 pc.	40x50x40
12PK-407540	See page 51	40x75x40
12PK-507550	See page 51	50x75x50
12PK-637563	See page 51	63x75x63
12PK-409040	See page 51	40x90x40
12PK-509050	See page 51	50x90x50
12PK-639063	See page 51	63x90x63
12PK-759075	See page 51	75x90x75

## Type: 13PK (CW617)



PK-TOOL p 170

T-female centre

T-binnendraad

Pièce en T femelle

T-IG

Article number	Bag / Box	Type
13PK-160416BP*	10 pc. / 50 pc.	16x1/2"x16
13PK-180418BP*	10 pc. / 50 pc.	18x1/2"x18
13PK-200420BP*	10 pc. / 50 pc.	20x1/2"x20
13PK-200520	10 pc. / 30 pc.	20x3/4"x20
13PK-260420BP*	5 pc. / 30 pc.	26x1/2"x20
13PK-260426BP*	5 pc. / 30 pc.	26x1/2"x26
13PK-260526	5 pc. / 30 pc.	26x3/4"x26
13PK-320532	5 pc. / 15 pc.	32x3/4"x32
13PK-320632	5 pc. / 10 pc.	32x1"x32
13PK-320732	5 pc. / 10 pc.	32x1 1/4"x32
13PK-400640	5 pc. / 10 pc.	40x1"x40
13PK-400740	5 pc. / 10 pc.	40x1 1/4"x40
13PK-500850	1 pc. / 4 pc.	50x1 1/2"x50
13PK-631063	1 pc. / 2 pc.	63x2"x63



## Type: 13PK-N (CW602)



PK-TOOL p 170

T-female centre  
T-binnendraad  
Pièce en T femelle  
T-IG

Article number	Bag / Box	Type
13PK-400640-N	5 pc. / 10 pc.	40x1"x40
13PK-400740-N	5 pc. / 10 pc.	40x1 1/4"x40
13PK-500850-N	1 pc. / 4 pc.	50x1 1/2"x50
13PK-631063-N	1 pc. / 2 pc.	63x2"x63

## Type: 14PK (CW617)



PK-TOOL p 170

T-male centre  
T-buitendraad  
Pièce en T mâle  
T-AG

Article number	Bag / Box	Type
14PK-160416	10 pc. / 50 pc.	16x1/2"x16
14PK-180418	10 pc. / 50 pc.	18x1/2"x18
14PK-200420	10 pc. / 40 pc.	20x1/2"x20
14PK-200520	10 pc. / 30 pc.	20x3/4"x20
14PK-260426	5 pc. / 30 pc.	26x1/2"x26
14PK-260526	5 pc. / 25 pc.	26x3/4"x26
14PK-260626	5 pc. / 20 pc.	26x1"x26
14PK-320532	5 pc. / 15 pc.	32x3/4"x32
14PK-400640	5 pc. / 10 pc.	40x1"x40
14PK-400740	5 pc. / 10 pc.	40x1 1/4"x40
14PK-500850	1 pc. / 5 pc.	50x1 1/2"x50
14PK-631063	1 pc. / 2 pc.	63x2"x63
14PK-751075	See page 52	75x2"x75
14PK-751275	See page 52	75x2 1/2"x75

## Type: 14PK-N (CW602)



PK-TOOL p 170

T-male centre  
T-buitendraad  
Pièce en T mâle  
T-AG

Article number	Bag / Box	Type
14PK-400640-N	5 pc. / 10 pc.	40x1"x40
14PK-400740-N	5 pc. / 10 pc.	40x1 1/4"x40
14PK-500850-N	1 pc. / 5 pc.	50x1 1/2"x50
14PK-631063-N	1 pc. / 2 pc.	63x2"x63

**Type: 15PK**



**Straight coupling**  
**Doorverbinder recht / perssok**  
**Manchon**  
**Kupplung**

Article number	Bag / Box	Type
15PK-1414	10 pc. / 150 pc.	14x14
15PK-1616	10 pc. / 150 pc.	16x16
15PK-1818	10 pc. / 100 pc.	18x18
15PK-2020	10 pc. / 80 pc.	20x20
15PK-2626	5 pc. / 50 pc.	26x26
15PK-3232	5 pc. / 30 pc.	32x32
15PK-4040	5 pc. / 25 pc.	40x40
15PK-5050	1 pc. / 12 pc.	50x50
15PK-6363	1 pc. / 9 pc.	63x63
15PK-7575	See page 52	75x75
15PK-9090	See page 52	90x90

**Type: 16PK**



**Reducing coupling**  
**Verloopstuk**  
**Réduction**  
**Kupplung-reduziert**

Article number	Bag / Box	Type
16PK-1614	10 pc. / 100 pc.	16x14
16PK-1814	10 pc. / 100 pc.	18x14
16PK-1816	10 pc. / 100 pc.	18x16
16PK-2014	10 pc. / 100 pc.	20x14
16PK-2016	10 pc. / 100 pc.	20x16
16PK-2018	10 pc. / 100 pc.	20x18
16PK-2616	5 pc. / 60 pc.	26x16
16PK-2618	5 pc. / 50 pc.	26x18
16PK-2620	5 pc. / 50 pc.	26x20
16PK-3216	5 pc. / 50 pc.	32x16
16PK-3220	5 pc. / 40 pc.	32x20
16PK-3226	5 pc. / 40 pc.	32x26
16PK-4026	5 pc. / 30 pc.	40x26
16PK-4032	5 pc. / 25 pc.	40x32
16PK-5032	1 pc. / 15 pc.	50x32
16PK-5040	1 pc. / 15 pc.	50x40
16PK-6340	1 pc. / 8 pc.	63x40
16PK-6350	1 pc. / 8 pc.	63x50
16PK-7532	See page 52	75x32
16PK-7540	See page 52	75x40
16PK-7550	See page 52	75x50
16PK-7563	See page 52	75x63
16PK-9032	See page 52	90x32
16PK-9040	See page 52	90x40
16PK-9050	See page 52	90x50
16PK-9063	See page 52	90x63
16PK-9075	See page 52	90x75



## Type: 17PK (CW617)



PK-TOOL p 170

**Straight male adapter**  
**Recht aansluitstuk buitendraad / Puntstuk**  
**Raccord droit mâle**  
**Übergangsfitting AG**

Article number	Bag / Box	Type
17PK-1404	10 pc. / 80 pc.	14x1/2"
17PK-1604	10 pc. / 80 pc.	16x1/2"
17PK-1804	10 pc. / 80 pc.	18x1/2"
17PK-1805	10 pc. / 50 pc.	18x3/4"
17PK-2004	10 pc. / 80 pc.	20x1/2"
17PK-2005	10 pc. / 50 pc.	20x3/4"
17PK-2605	10 pc. / 50 pc.	26x3/4"
17PK-2606	10 pc. / 40 pc.	26x1"
17PK-3206	10 pc. / 40 pc.	32x1"
17PK-3207	5 pc. / 25 pc.	32x1 1/4"
17PK-4006	5 pc. / 25 pc.	40x1"
17PK-4007	5 pc. / 25 pc.	40x1 1/4"
17PK-5008	1 pc. / 10 pc.	50x1 1/2"
17PK-6310	1 pc. / 6 pc.	63x2"
17PK-7510	See page 53	75x2"
17PK-7512	See page 53	75x2 1/2"

## Type: 17PK-N (CW602)



PK-TOOL p 170

**Straight male adapter**  
**Recht aansluitstuk buitendraad / Puntstuk**  
**Raccord droit mâle**  
**Übergangsfitting AG**

Article number	Bag / Box	Type
17PK-4006-N	5 pc. / 25 pc.	40x1"
17PK-4007-N	5 pc. / 25 pc.	40x1 1/4"
17PK-5008-N	1 pc. / 10 pc.	50x1 1/2"
17PK-6310-N	1 pc. / 6 pc.	63x2"

## Type: 18PK (CW617)



PK-TOOL p 170

**Straight female adapter**  
**Recht aansluitstuk binnendraad / Schroefbus**  
**Raccord droit femelle**  
**Übergangsfitting IG**

Article number	Bag / Box	Type
18PK-1404	10 pc. / 80 pc.	14x1/2"
18PK-1604	10 pc. / 80 pc.	16x1/2"
18PK-1804	10 pc. / 80 pc.	18x1/2"
18PK-1805	10 pc. / 50 pc.	18x3/4"
18PK-2004	10 pc. / 80 pc.	20x1/2"
18PK-2005	10 pc. / 50 pc.	20x3/4"
18PK-2605	10 pc. / 50 pc.	26x3/4"
18PK-2606	10 pc. / 40 pc.	26x1"
18PK-3206	10 pc. / 40 pc.	32x1"
18PK-3207	5 pc. / 25 pc.	32x1 1/4"
18PK-4006	5 pc. / 25 pc.	40x1"
18PK-4007	5 pc. / 25 pc.	40x1 1/4"
18PK-5008	1 pc. / 10 pc.	50x1 1/2"
18PK-6310	1 pc. / 6 pc.	63x2"
18PK-7506	See page 53	75x1"
18PK-7510	See page 53	75x2"
18PK-7512	See page 53	75x2 1/2"
18PK-9014	See page 53	90x3"

## Type: 18PK-N (CW602)



PK-TOOL p 170

**Straight female adapter**  
**Recht aansluitstuk binnendraad / Schroefbus**  
**Raccord droit femelle**  
**Übergangsfitting IG**

Article number	Bag / Box	Type
18PK-4006-N	5 pc. / 25 pc.	40x1"
18PK-4007-N	5 pc. / 25 pc.	40x1 1/4"
18PK-5008-N	1 pc. / 10 pc.	50x1 1/2"
18PK-6310-N	1 pc. / 6 pc.	63x2"

## Type: 19PK



**Press fit with swivel to eurocone**  
**Perskoppeling met wartel en euroconus aansluiting**  
**Raccord à sertir avec ecrou à visser eurocone**  
**Pressfitting mit Drehbar und Eurokonus**

Article number	Bag / Box	Type
19PK-1605	10 pc. / 80 pc.	16x3/4"
19PK-2005	10 pc. / 80 pc.	20x3/4"





## Type: 26PK



Press fitting with swivel and flat sealing  
 Perskoppeling met wartel en vlakke dichting  
 Raccord avec écrou et joint plat  
 Pressfitting mit Drehbar und flach Versiegelung

Article number	Bag / Box	Type
26PK-1605	10 pc. / 80 pc.	16x3/4"
26PK-2005	10 pc. / 80 pc.	20x3/4"

## Type: 26PK (CW617)



Press fitting with swivel and flat sealing  
 Perskoppeling met wartel en vlakke dichting  
 Raccord avec écrou et joint plat  
 Pressfitting mit Drehbar und flach Versiegelung

Article number	Bag / Box	Type
26PK-4008	5 pc. / 15 pc.	40x1 1/2"
26PK-5010	1 pc. / 10 pc.	50x2"
26PK-6312	1 pc. / 6 pc.	63x2 1/2"

## Type: 27PK



45° bend  
 Bocht 45°  
 Coude 45°  
 Winkel 45°

Article number	Bag / Box	Type
27PK-4040	5 pc. / 25 pc.	40x40
27PK-5050	1 pc. / 10 pc.	50x50
27PK-6363	1 pc. / 5 pc.	63x63
27PK-7575	See page 53	75x75
27PK-9090	See page 53	90x90

## Type: 28PK-04



Bracket wallplate for 2PK, 6PK and 13PK, interaxis 153mm  
 Muurplaatbeugel voor 2PK, 6PK en 13PK, asafstand 153mm  
 Attache culasse pour 2PK, 6PK et 13PK, entraxe 153mm  
 Bügel Wandscheibe für 28PK-2PK1604 und 28PK-6PK-1604, Mitte-zu-Mitte-Abstand

Article number	Box	Type
28PK-04	50 pc.	1/2"

- 1
- 2
- 3
- 4
- 5
- 6
- 7
- 8
- 9
- 10
- 11

**Type: 28PK-2PK1604**



Double backplate 153mm centres for art. 2PK-1604  
 Dubbele muurplaat 153mm asafstand voor art. 2PK-1604  
 Culasse double, entraxe 153mm pour art. 2PK-1604  
 Wandwinkel doppelt 153mm Abstand für Art. 2PK-1604

Article number	Bag / Box	Type
28PK-2PK1604BP *	2 pc. / 10 pc.	2x(16x1/2")

\* With black plug BP04 1/2"  
 TILL EXHAUSTION OF STOCK

**Type: 28PK-6PK1604**



Double backplate 153mm centres for art. 6PK-1604  
 Dubbele muurplaat 153mm asafstand voor art. 6PK-1604  
 Culasse double, entraxe 153mm pour art. 6PK-1604  
 Wandwinkel doppelt 153mm Abstand für Art. 6PK-1604

Article number	Bag / Box	Type
28PK-6PK1604BP *	2 pc. / 18 pc.	2x(16x1/2")

\* With black plug BP04 1/2"  
 TILL EXHAUSTION OF STOCK

**Type: 53PK**



Easy mounting fitting  
 Eenvoudige montage fitting  
 Raccord montage facile  
 Einfache Montage Fitting

Article number	Bag / Box	Type
53PK40	1 pc. / 20 pc.	40x40
53PK50	1 pc. / 9 pc.	50x50
53PK63	1 pc. / 6 pc.	63x63

for Ø16, 20, 26 and 32: chapter 4, article 52P



### Type: 1PKW



Elbow 90°  
Knie 90°  
Coude 90°  
Winkel 90°

Article number	Bag / Box	Type
1PKW-1616	10 pc. / 120 pc.	16x16
1PKW-2020	10 pc. / 80 pc.	20x20
1PKW-2626	5 pc. / 50 pc.	26x26
1PKW-3232	5 pc. / 30 pc.	32x32

### Type: 2PKW (CW617)



Backplate elbow female  
Sanitair muurplaat binnendraad  
Culasse pour sanitaire  
Sanitär Wandscheibe IG

Article number	Bag / Box	Type
2PKW-1604	10 pc. / 50 pc.	16x1/2" (56 mm)
2PKW-2004	10 pc. / 50 pc.	20x1/2" (56 mm)
2PKW-2005	5 pc. / 30 pc.	20x3/4" (56 mm)
2PKW-2605	5 pc. / 30 pc.	26x3/4" (56 mm)

### Type: 2PKW-N (CW602)



Backplate elbow female  
Sanitair muurplaat binnendraad  
Culasse pour sanitaire  
Sanitär Wandscheibe IG

Article number	Bag / Box	Type
2PKW-1604-N	10 pc. / 50 pc.	16x1/2" (56 mm)
2PKW-2004-N	10 pc. / 50 pc.	20x1/2" (56 mm)
2PKW-2005-N	5 pc. / 30 pc.	20x3/4" (56 mm)
2PKW-2605-N	5 pc. / 30 pc.	26x3/4" (56 mm)

### Type: 2PKW-K (CW617)



Backplate elbow female, short model,  
Sanitair muurplaat binnendraad, kort model  
Culasse pour sanitaire, modèle court  
Sanitär Wandscheibe IG, kurzes Modell

Article number	Bag / Box	Type
2PKW-1604K	10 pc. / 50 pc.	16x1/2" (40 mm)

Accessory 2PKW, 2PKW-N, 2PKW-K: galvanised bracket plate - see page 168



PLP-P-PK



PLF-P-PK

## Type: 3PKW (CW617)



Double backplate elbow female, short model  
 Sanitair muurplaat binnendraad dubbel, laag  
 Culasse double pour sanitaire, modèle court  
 Sanitär Wandscheibe doppelt IG, kurzes Modell

Article number	Bag / Box	Type
3PKW-160416	10 pc. / 30 pc.	16x1/2"x16 (40 mm)
3PKW-200420	10 pc. / 30 pc.	20x1/2"x20 (40 mm)

## Type: 3PKW-N (CW602)



Double backplate elbow female, short model  
 Sanitair muurplaat binnendraad dubbel, laag  
 Culasse double pour sanitaire, modèle court  
 Sanitär Wandscheibe doppelt IG, kurzes Modell

Article number	Bag / Box	Type
3PKW-160416-N	10 pc. / 30 pc.	16x1/2"x16 (40 mm)
3PKW-200420-N	10 pc. / 30 pc.	20x1/2"x20 (40 mm)

## Type: 5PKW (CW617)



PK-TOOL p 170

Bend 90° male adapter  
 Knie 90° buitendraad  
 Coude 90° mâle  
 Winkel 90° AG

Article number	Bag / Box	Type
5PKW-1604	10 pc. / 60 pc.	16x1/2"
5PKW-2004	10 pc. / 60 pc.	20x1/2"
5PKW-2005	10 pc. / 50 pc.	20x3/4"
5PKW-2605	10 pc. / 40 pc.	26x3/4"
5PKW-3206	5 pc. / 20 pc.	32x1"

## Type: 5PKW-N (CW602)



PK-TOOL p 170

Bend 90° male adapter  
 Knie 90° buitendraad  
 Coude 90° mâle  
 Winkel 90° AG

Article number	Bag / Box	Type
5PKW-1604-N	10 pc. / 60 pc.	16x1/2"
5PKW-2004-N	10 pc. / 60 pc.	20x1/2"
5PKW-2005-N	10 pc. / 50 pc.	20x3/4"
5PKW-2605-N	10 pc. / 40 pc.	26x3/4"
5PKW-3206-N	5 pc. / 20 pc.	32x1"

## B. PKW



### Type: 6PKW (CW617)



PK-TOOL p 170

Bend 90° female adapter  
Knie 90° binnendraad  
Coude 90° femelle  
Winkel 90° IG

Article number	Bag / Box	Type
6PKW-1603	10 pc. / 60 pc.	16x3/8"
6PKW-1604	10 pc. / 60 pc.	16x1/2"
6PKW-2004	10 pc. / 60 pc.	20x1/2"
6PKW-2005	10 pc. / 50 pc.	20x3/4"
6PKW-2605	10 pc. / 50 pc.	26x3/4"
6PKW-3206	5 pc. / 20 pc.	32x1"

### Type: 6PKW-N (CW602)



PK-TOOL p 170

Bend 90° female adapter  
Knie 90° binnendraad  
Coude 90° femelle  
Winkel 90° IG

Article number	Bag / Box	Type
6PKW-1603-N	10 pc. / 60 pc.	16x3/8"
6PKW-1604-N	10 pc. / 60 pc.	16x1/2"
6PKW-2004-N	10 pc. / 60 pc.	20x1/2"
6PKW-2005-N	10 pc. / 50 pc.	20x3/4"
6PKW-2605-N	10 pc. / 50 pc.	26x3/4"
6PKW-3206-N	5 pc. / 20 pc.	32x1"

### Type: 9PKW



PK-TOOL p 170

T-piece  
T-stuk  
Pièce en T  
T-Stück

Article number	Bag / Box	Type
9PKW-161616	10 pc. / 60 pc.	16x16x16
9PKW-202020	10 pc. / 50 pc.	20x20x20
9PKW-262626	5 pc. / 30 pc.	26x26x26
9PKW-323232	5 pc. / 15 pc.	32x32x32

### Type: 10PKW



PK-TOOL p 170

T-reduced centre  
T-verlopend  
T-réduit  
T-reduziert

Article number	Bag / Box	Type
10PKW-201620	10 pc. / 50 pc.	20x16x20
10PKW-261626	5 pc. / 30 pc.	26x16x26
10PKW-262026	5 pc. / 30 pc.	26x20x26
10PKW-321632	5 pc. / 25 pc.	32x16x32
10PKW-322032	5 pc. / 25 pc.	32x20x32
10PKW-322632	5 pc. / 20 pc.	32x26x32

## Type: 11PKW



T-branch and line reduced

T-2X verlopend

T-2X réduit

T-2X reduziert

Article number	Bag / Box	Type
11PKW-201616	10 pc. / 50 pc.	20x16x16
11PKW-202016	10 pc. / 50 pc.	20x20x16
11PKW-261616	10 pc. / 50 pc.	26x16x16
11PKW-261620	5 pc. / 30 pc.	26x16x20
11PKW-262016	5 pc. / 30 pc.	26x20x16
11PKW-262020	5 pc. / 30 pc.	26x20x20
11PKW-262616	5 pc. / 30 pc.	26x26x16
11PKW-262620	5 pc. / 30 pc.	26x26x20
11PKW-322026	5 pc. / 20 pc.	32x20x26
11PKW-322626	5 pc. / 20 pc.	32x26x26

## Type: 12PKW



T-enlarged branch

T-vergroot

T-agrandi

T-erweitert

Article number	Bag / Box	Type
12PKW-162016	10 pc. / 50 pc.	16x20x16
12PKW-202620	5 pc. / 30 pc.	20x26x20
12PKW-263226	5 pc. / 20 pc.	26x32x26

## Type: 13PKW (CW617)



PK-TOOL p 170

T-female centre

T-binnendraad

T-femelle

T-IG

Article number	Bag / Box	Type
13PKW-160416	10 pc. / 50 pc.	16x1/2"x16
13PKW-200420	10 pc. / 50 pc.	20x1/2"x20
13PKW-200520	10 pc. / 30 pc.	20x3/4"x20
13PKW-260426	5 pc. / 30 pc.	26x1/2"x26
13PKW-260526	5 pc. / 30 pc.	26x3/4"x26
13PKW-320532	5 pc. / 15 pc.	32x3/4"x32
13PKW-320632	5 pc. / 10 pc.	32x1"x32



## Type: 13PKW-N (CW602)



PK-TOOL p 170

T-female centre  
T-binnendraad  
T-femelle  
T-IG

Article number	Bag / Box	Type
13PKW-160416-N	10 pc. / 50 pc.	16x1/2"x16
13PKW-200420-N	10 pc. / 50 pc.	20x1/2"x20
13PKW-200520-N	10 pc. / 30 pc.	20x3/4"x20
13PKW-260426-N	5 pc. / 30 pc.	26x1/2"x26
13PKW-260526-N	5 pc. / 30 pc.	26x3/4"x26
13PKW-320532-N	5 pc. / 15 pc.	32x3/4"x32
13PKW-320632-N	5 pc. / 10 pc.	32x1"x32

## Type: 14PKW (CW617)



PK-TOOL p 170

T-male centre  
T-buitendraad  
T-mâle  
T-AG

Article number	Bag / Box	Type
14PKW-160416	10 pc. / 50 pc.	16x1/2"x16
14PKW-200420	10 pc. / 40 pc.	20x1/2"x20
14PKW-200520	10 pc. / 30 pc.	20x3/4"x20
14PKW-320532	5 pc. / 15 pc.	32x3/4"x32

## Type: 14PKW-N (CW602)



PK-TOOL p 170

T-male centre  
T-buitendraad  
T-mâle  
T-AG

Article number	Bag / Box	Type
14PKW-160416-N	10 pc. / 50 pc.	16x1/2"x16
14PKW-200420-N	10 pc. / 40 pc.	20x1/2"x20
14PKW-200520-N	10 pc. / 30 pc.	20x3/4"x20

## Type: 15PKW



Straight coupling  
Doorverbinder recht  
Manchon  
Kupplung

Article number	Bag / Box	Type
15PKW-1616	10 pc. / 150 pc.	16x16
15PKW-2020	10 pc. / 80 pc.	20x20
15PKW-2626	5 pc. / 50 pc.	26x26
15PKW-3232	5 pc. / 30 pc.	32x32

## Type: 16PKW



Reducing coupling  
Verloopstuk  
Réduction  
Kupplung-reduziert

Article number	Bag / Box	Type
16PKW-2016	10 pc. / 100 pc.	20x16
16PKW-2616	5 pc. / 60 pc.	26x16
16PKW-2620	5 pc. / 50 pc.	26x20
16PKW-3216	5 pc. / 50 pc.	32x16
16PKW-3220	5 pc. / 40 pc.	32x20
16PKW-3226	5 pc. / 40 pc.	32x26

## Type: 17PKW (CW617)



PK-TOOL p 170

Straight male adapter  
Recht aansluitstuk buitendraad / Puntstuk  
Raccord droit mâle  
Übergangsfitting AG

Article number	Bag / Box	Type
17PKW-1604	10 pc. / 80 pc.	16x1/2"
17PKW-2004	10 pc. / 80 pc.	20x1/2"
17PKW-2005	10 pc. / 50 pc.	20x3/4"
17PKW-2605	10 pc. / 50 pc.	26x3/4"
17PKW-2606	10 pc. / 40 pc.	26x1"
17PKW-3206	10 pc. / 40 pc.	32x1"
17PKW-3207	5 pc. / 25 pc.	32 x 1 1/4"

## Type: 17PKW-N (CW602)



PK-TOOL p 170

Straight male adapter  
Recht aansluitstuk buitendraad / Puntstuk  
Raccord droit mâle  
Übergangsfitting AG

Article number	Bag / Box	Type
17PKW-1604-N	10 pc. / 80 pc.	16x1/2"
17PKW-2004-N	10 pc. / 80 pc.	20x1/2"
17PKW-2005-N	10 pc. / 50 pc.	20x3/4"
17PKW-2605-N	10 pc. / 50 pc.	26x3/4"
17PKW-2606-N	10 pc. / 40 pc.	26x1"
17PKW-3206-N	10 pc. / 40 pc.	32x1"
17PKW-3207-N	5 pc. / 25 pc.	32 x 1 1/4"



## B. PKW



### Type: 18PKW (CW617)



PK-TOOL p 170

**Straight female adapter**  
**Recht aansluitstuk binnendraad / Schroefbus**  
**Raccord droit femelle**  
**Übergangsfitting IG**

Article number	Bag / Box	Type
18PKW-1604	10 pc. / 80 pc.	16x1/2"
18PKW-2004	10 pc. / 80 pc.	20x1/2"
18PKW-2005	10 pc. / 50 pc.	20x3/4"
18PKW-2605	10 pc. / 50 pc.	26x3/4"
18PKW-2606	10 pc. / 40 pc.	26x1"
18PKW-3206	10 pc. / 40 pc.	32x1"
18PKW-3207	5 pc. / 25 pc.	32x1 1/4"

### Type: 18PKW-N (CW602)



PK-TOOL p 170

**Straight female adapter**  
**Recht aansluitstuk binnendraad / Schroefbus**  
**Raccord droit femelle**  
**Übergangsfitting IG**

Article number	Bag / Box	Type
18PKW-1604-N	10 pc. / 80 pc.	16x1/2"
18PKW-2004-N	10 pc. / 80 pc.	20x1/2"
18PKW-2005-N	10 pc. / 50 pc.	20x3/4"
18PKW-2605-N	10 pc. / 50 pc.	26x3/4"
18PKW-2606-N	10 pc. / 40 pc.	26x1"
18PKW-3206-N	10 pc. / 40 pc.	32x1"
18PKW-3207-N	5 pc. / 25 pc.	32x1 1/4"

### Type: 19PKW



**Press fitting to eurocone**  
**Perskoppeling met euroconus aansluiting**  
**Raccord avec raccord à visser eurocone**  
**Pressfitting mit Eurokonus**

Article number	Bag / Box	Type
19PKW-1605	10 pc. / 80 pc.	16x3/4"
19PKW-2005	10 pc. / 80 pc.	20x3/4"

### Type: 26PKW



**Press fitting with flat sealing**  
**Perskoppeling met vlakke dichting**  
**Raccord avec etachéité plate**  
**Pressfitting mit flach Versiegelung**

Article number	Bag / Box	Type
26PKW-1605	10 pc. / 80 pc.	16x3/4"
26PKW-2005	10 pc. / 80 pc.	20x3/4"

Gas: only allowed in countries where has been a HENCO GAS testing + certificate is available! (See [www.henco.be](http://www.henco.be))  
 Gas: enkel toegelaten in landen waar er een HENCO GAS keur is + een certificaat voorhanden is! (zie [www.henco.be](http://www.henco.be))  
 Gaz: seulement permis dans des pays où le contrôle a eu lieu + certificat est disponible! (Consultez [www.henco.be](http://www.henco.be))  
 Gas: nur zugelassen in Länder wo HENCO GAS Prüfung geschehen ist + Zertifikat vorhanden ist! (Siehe [www.henco.be](http://www.henco.be))

Henco press fittings PVDF for gas in combination with standard pipe gas, see page 19



## Type: 1PKG



Elbow 90°  
 Knie 90°  
 Coude 90°  
 Winkel 90°

Article number	Bag / Box	Type
1PKG-1616	10 pc. / 120 pc.	16x16
1PKG-2020	10 pc. / 80 pc.	20x20
1PKG-2626	5 pc. / 50 pc.	26x26
1PKG-3232	5 pc. / 30 pc.	32x32
1PKG-4040	5 pc. / 20 pc.	40x40

## Type: 2PKG



Backplate elbow female  
 Muurplaat binnendraad  
 Culasse femelle  
 Wandscheibe IG

Article number	Bag / Box	Type
2PKG-1603	10 pc. / 50 pc.	16x3/8" (56 mm)
2PKG-1604BP *	10 pc. / 50 pc.	16x1/2" (56 mm)
2PKG-2004BP *	10 pc. / 50 pc.	20x1/2" (56 mm)
2PKG-2005	5 pc. / 30 pc.	20x3/4" (56 mm)
2PKG-2605	5 pc. / 30 pc.	26x3/4" (56 mm)

\* With black plug BP04 1/2"

## Type: 2PKG-K



Backplate elbow female, short model  
 Muurplaat binnendraad, laag  
 Culasse femelle, modèle court  
 Wandscheibe IG, kurzes Modell

Article number	Bag / Box	Type
2PKG-1604KBP *	10 pc. / 50 pc.	16x1/2" (40 mm)

\* With black plug BP04 1/2"



## Type: 3PKG



Double backplate elbow female, short model  
 Muurplaat binnendraad dubbel, laag  
 Culasse double, modèle court  
 Wandscheibe doppelt IG, kurzes Modell

Article number	Bag / Box	Type
3PKG-200420BP *	10 pc. / 30 pc.	20x1/2"x20 (40 mm)

\* With black plug BP04 1/2"

## Type: 5PKG



PK-TOOL p 170

Bend 90° male adapter  
 Knie 90° buitendraad  
 Coude 90° mâle  
 Winkel 90° AG

Article number	Bag / Box	Type
5PKG-1604	10 pc. / 60 pc.	16x1/2"
5PKG-2004	10 pc. / 60 pc.	20x1/2"
5PKG-2005	10 pc. / 50 pc.	20x3/4"
5PKG-2605	10 pc. / 40 pc.	26x3/4"
5PKG-3206	5 pc. / 20 pc.	32x1"
5PKG-4007	5 pc. / 15 pc.	40x1 1/4"

## Type: 6PKG



PK-TOOL p 170

Bend 90° female adapter  
 Knie 90° binnendraad  
 Coude 90° femelle  
 Winkel 90° IG

Article number	Bag / Box	Type
6PKG-1604BP *	10 pc. / 60 pc.	16x1/2"
6PKG-2004BP *	10 pc. / 60 pc.	20x1/2"
6PKG-2005	10 pc. / 50 pc.	20x3/4"
6PKG-2605	10 pc. / 50 pc.	26x3/4"
6PKG-3206	5 pc. / 20 pc.	32x1"
6PKG-4007	5 pc. / 15 pc.	40x1 1/4"

\* With black plug BP04 1/2"

## Type: 9PKG



T-piece  
 T-stuk  
 Pièce en T  
 T-Stück

Article number	Bag / Box	Type
9PKG-161616	10 pc. / 60 pc.	16x16x16
9PKG-202020	10 pc. / 50 pc.	20x20x20
9PKG-262626	5 pc. / 30 pc.	26x26x26
9PKG-323232	5 pc. / 15 pc.	32x32x32
9PKG-404040	5 pc. / 10 pc.	40x40x40

## Type: 10PKG



T-reduced centre

T-verlopend

Pièce en T réduit

T-reduziert

Article number	Bag / Box	Type
10PKG-201620	10 pc. / 50 pc.	20x16x20
10PKG-261626	5 pc. / 30 pc.	26x16x26
10PKG-262026	5 pc. / 30 pc.	26x20x26
10PKG-321632	5 pc. / 25 pc.	32x16x32
10PKG-322032	5 pc. / 25 pc.	32x20x32
10PKG-322632	5 pc. / 20 pc.	32x26x32
10PKG-401640	5 pc. / 15 pc.	40x16x40
10PKG-402040	5 pc. / 15 pc.	40x20x40
10PKG-402640	5 pc. / 15 pc.	40x26x40
10PKG-403240	5 pc. / 10 pc.	40x32x40

## Type: 11PKG



T-branch and line reduced

T-2X verlopend

Pièce en T 2X réduit

T-2X reduziert

Article number	Bag / Box	Type
11PKG-201616	10 pc. / 50 pc.	20x16x16
11PKG-202016	10 pc. / 50 pc.	20x20x16
11PKG-261620	5 pc. / 30 pc.	26x16x20
11PKG-262016	5 pc. / 30 pc.	26x20x16
11PKG-262020	5 pc. / 30 pc.	26x20x20
11PKG-262616	5 pc. / 30 pc.	26x26x16
11PKG-262620	5 pc. / 30 pc.	26x26x20
11PKG-322026	5 pc. / 20 pc.	32x20x26
11PKG-322626	5 pc. / 20 pc.	32x26x26
11PKG-402032	5 pc. / 15 pc.	40x20x32
11PKG-402632	5 pc. / 15 pc.	40x26x32
11PKG-403232	5 pc. / 10 pc.	40x32x32
11PKG-404026	5 pc. / 10 pc.	40x40x26
11PKG-404032	5 pc. / 10 pc.	40x40x32

## Type: 12PKG



T-enlarged branch

T-vergroot

Pièce en T agrandi

T-erweitert

Article number	Bag / Box	Type
12PKG-162016	10 pc. / 50 pc.	16x20x16
12PKG-202620	5 pc. / 30 pc.	20x26x20
12PKG-263226	5 pc. / 20 pc.	26x32x26
12PKG-324032	5 pc. / 15 pc.	32x40x32



## Type: 13PKG



PK-TOOL p 170

**T-female branch**  
**T-binnendraad**  
**Pièce en T femelle**  
**T-IG**

Article number	Bag / Box	Type
13PKG-160416BP *	10 pc. / 50 pc.	16x1/2"x16
13PKG-200420BP *	10 pc. / 50 pc.	20x1/2"x20
13PKG-200520	10 pc. / 30 pc.	20x3/4"x20
13PKG-260420BP *	5 pc. / 30 pc.	26x1/2"x20
13PKG-260426BP *	5 pc. / 30 pc.	26x1/2"x26
13PKG-260526	5 pc. / 30 pc.	26x3/4"x26
13PKG-320532	5 pc. / 15 pc.	32x3/4"x32
13PKG-320632	5 pc. / 10 pc.	32x1"x32
13PKG-320732	5 pc. / 10 pc.	32x1 1/4"x32
13PKG-400640	5 pc. / 10 pc.	40x1"x40
13PKG-400740	5 pc. / 10 pc.	40x1 1/4"x40

\* With black plug BP04 1/2"

## Type: 14PKG



PK-TOOL p 170

**T-male branch**  
**T-buitendraad**  
**Pièce en T mâle**  
**T-AG**

Article number	Bag / Box	Type
14PKG-160416	10 pc. / 50 pc.	16x1/2"x16
14PKG-200420	10 pc. / 40 pc.	20x1/2"x20
14PKG-260426	5 pc. / 30 pc.	26x1/2"x26
14PKG-260626	5 pc. / 20 pc.	26x1"x26
14PKG-320532	5 pc. / 15 pc.	32x3/4"x32
14PKG-400740	5 pc. / 10 pc.	40x1 1/4"x40

## Type: 15PKG



**Straight coupling**  
**Doorverbinder recht / perssok**  
**Manchon**  
**Kupplung**

Article number	Bag / Box	Type
15PKG-1616	10 pc. / 150 pc.	16x16
15PKG-2020	10 pc. / 80 pc.	20x20
15PKG-2626	5 pc. / 50 pc.	26x26
15PKG-3232	5 pc. / 30 pc.	32x32
15PKG-4040	5 pc. / 25 pc.	40x40

## Type: 16PKG



Reducing coupling  
Verloopstuk  
Réduction  
Kupplung-reduziert

Article number	Bag / Box	Type
16PKG-2016	10 pc. / 100 pc.	20x16
16PKG-2616	5 pc. / 60 pc.	26x16
16PKG-2620	5 pc. / 50 pc.	26x20
16PKG-3216	5 pc. / 50 pc.	32x16
16PKG-3220	5 pc. / 40 pc.	32x20
16PKG-3226	5 pc. / 40 pc.	32x26
16PKG-4026	5 pc. / 30 pc.	40x26
16PKG-4032	5 pc. / 25 pc.	40x32

## Type: 17PKG



PK-TOOL p 170

Straight male adapter  
Recht aansluitstuk buitendraad / Puntstuk  
Raccord droit mâle  
Übergangsfitting AG

Article number	Bag / Box	Type
17PKG-1604	10 pc. / 80 pc.	16x1/2"
17PKG-2004	10 pc. / 80 pc.	20x1/2"
17PKG-2005	10 pc. / 50 pc.	20x3/4"
17PKG-2605	10 pc. / 50 pc.	26x3/4"
17PKG-2606	10 pc. / 40 pc.	26x1"
17PKG-3206	10 pc. / 40 pc.	32x1"
17PKG-3207	5 pc. / 25 pc.	32x1 1/4"
17PKG-4006	5 pc. / 25 pc.	40x1"
17PKG-4007	5 pc. / 25 pc.	40x1 1/4"

## Type: 18PKG



PK-TOOL p 170

Straight female adapter  
Recht aansluitstuk binnendraad / Schroefbus  
Raccord droit femelle  
Übergangsfitting IG

Article number	Bag / Box	Type
18PKG-1604	10 pc. / 80 pc.	16x1/2"
18PKG-2004	10 pc. / 80 pc.	20x1/2"
18PKG-2005	10 pc. / 50 pc.	20x3/4"
18PKG-2605	10 pc. / 50 pc.	26x3/4"
18PKG-2606	10 pc. / 40 pc.	26x1"
18PKG-3206	10 pc. / 40 pc.	32x1"
18PKG-3207	5 pc. / 25 pc.	32x1 1/4"
18PKG-4006	5 pc. / 25 pc.	40x1"
18PKG-4007	5 pc. / 25 pc.	40x1 1/4"

## Type: 27PKG



45° bend  
Bocht 45°  
Coude 45°  
Winkel 45°

Article number	Bag / Box	Type
27PKG-4040	5 pc. / 25 pc.	40x40

## D. PKS



Henco press fittings PVDF for Sprinkler in combination with standard pipe Sprinkler, see page 20



### Type: 1PKS



Elbow 90°  
Bocht 90°  
Coude 90°  
Winkel 90°

Article number	Bag / Box	Type
1PKS-2626	5 pc. / 50 pc.	26 x 26
1PKS-3232	5 pc. / 30 pc.	32 x 32
1PKS-4040	5 pc. / 20 pc.	40 x 40
1PKS-5050	1 pc. / 8 pc.	50x 50
1PKS-6363	1 pc. / 6 pc.	63 x 63

### Type: 5PKS (CW617)



Elbow 90° male adapter  
Bocht 90° buitendraad  
Coude 90° mâle  
Winkel 90° AG

Article number	Bag / Box	Type
5PKS-3206	5 pc. / 20 pc.	32 x 1"
5PKS-4007	3 pc. / 15 pc.	40 x 1,1/4"
5PKS-5007	1 pc. / 10 pc.	50x 1,1/4"
5PKS-5008	1 pc. / 8 pc.	50x 1,1/2"
5PKS-6310	1 pc. / 4 pc.	63 x 2"

### Type: 5PKS-N (CW602)



Elbow 90° male adapter  
Bocht 90° buitendraad  
Coude 90° mâle  
Winkel 90° AG

Article number	Bag / Box	Type
5PKS-3206-N	5 pc. / 20 pc.	32 x 1"
5PKS-4007-N	5 pc. / 15 pc.	40 x 1,1/4"
5PKS-5007-N	1 pc. / 8 pc.	50x 1,1/4"
5PKS-5008-N	1 pc. / 8 pc.	50x 1,1/2"
5PKS-6310-N	1 pc. / 4 pc.	63 x 2"

### Type: 6PKS (CW617)



Elbow 90° female adapter  
Bocht 90° binnendraad  
Coude 90° femelle  
Winkel 90° IG

Article number	Bag / Box	Type
6PKS-2604	10 pc. / 50 pc.	26 x 1/2"
6PKS-3204	5 pc. / 20 pc.	32 x 1/2"
6PKS-3206	5 pc. / 20 pc.	32 x 1"
6PKS-4004	3 pc. / 15 pc.	40 x 1/2"
6PKS-4007	5 pc. / 15 pc.	40 x 1,1/4"
6PKS-5004	1 pc. / 8 pc.	50x 1/2"
6PKS-5007	1 pc. / 8 pc.	50x 1,1/4"
6PKS-5008	1 pc. / 8 pc.	50x 1,1/2"
6PKS-6304	1 pc. / 4 pc.	63 x 1/2"
6PKS-6310	1 pc. / 4 pc.	63 x 2"

## Type: 6PKS-N (CW602)



Elbow 90° female adapter  
 Bocht 90° binnendraad  
 Coude 90° femelle  
 Winkel 90° IG

Article number	Bag / Box	Type
6PKS-2604-N	10 pc. / 50 pc.	26 x 1/2"
6PKS-3204-N	5 pc. / 20 pc.	32 x 1/2"
6PKS-3206-N	5 pc. / 20 pc.	32 x 1"
6PKS-4004-N	3 pc. / 15 pc.	40 x 1/2"
6PKS-4007-N	5 pc. / 15 pc.	40 x 1,1/4"
6PKS-5004-N	1 pc. / 8 pc.	50x 1/2"
6PKS-5007-N	1 pc. / 8 pc.	50x 1,1/4"
6PKS-5008-N	1 pc. / 8 pc.	50x 1,1/2"
6PKS-6304-N	1 pc. / 4 pc.	63 x 1/2"
6PKS-6310-N	1 pc. / 4 pc.	63 x 2"

## Type: 9PKS



T-piece  
 T-stuk  
 Pièce en T  
 T-Stück

Article number	Bag / Box	Type
9PKS-262626	5 pc. / 30 pc.	26 x 26 x 26
9PKS-323232	5 pc. / 15 pc.	32 x 32 x 32
9PKS-404040	5 pc. / 10 pc.	40 x 40 x 40
9PKS-505050	1 pc. / 6 pc.	50 x 50 x 50
9PKS-636363	1 pc. / 3 pc.	63 x 63 x 63

## Type: 10PKS



T-reduced centre  
 T-verlopend  
 Pièce en T réduit  
 T-reduziert

Article number	Bag / Box	Type
10PKS-322632	5 pc. / 20 pc.	32 x 26 x 32
10PKS-402640	5 pc. / 15 pc.	40 x 26 x 40
10PKS-403240	5 pc. / 10 pc.	40 x 32 x 40
10PKS-503250	1 pc. / 8 pc.	50 x 32 x 50
10PKS-504050	1 pc. / 6 pc.	50 x 40 x 50
10PKS-633263	1 pc. / 3 pc.	63 x 32 x 63
10PKS-634063	1 pc. / 3 pc.	63 x 40 x 63
10PKS-635063	1 pc. / 3 pc.	63 x 50 x 63

## Type: 11PKS



T-branch and line reduced  
 T-2x verlopend  
 Pièce en T 2x réduit  
 T-2x reduziert

Article number	Bag / Box	Type
11PKS-403232	5 pc. / 10 pc.	40 x 32 x 32
11PKS-404032	5 pc. / 10 pc.	40 x 40 x 32
11PKS-503240	1 pc. / 10 pc.	50 x 32 x 40
11PKS-504040	1 pc. / 8 pc.	50 x 40 x 40



## D. PKS



### Type: 12PKS



T-enlarged branch  
T-vergroot  
Oìce en T agrandi  
T-erwitert

Article number	Bag / Box	Type
12PKS-324032	5 pc. / 15 pc.	32 x 40 x 32
12PKS-405040	1 pc. / 8 pc.	40 x 50 x 40

### Type: 13PKS (CW617)



T-female branch  
T-binnendraad  
Pièce en T femelle  
T-IG

Article number	Bag / Box	Type
13PKS-260426	5 pc. / 30 pc.	26 x 1/2" x 26
13PKS-320432	5 pc. / 20 pc.	32 x 1/2" x 32
13PKS-320532	5 pc. / 15 pc.	32 x 3/4" x 32
13PKS-320632	5 pc. / 10 pc.	32 x 1" x 32
13PKS-320732	5 pc. / 10 pc.	32 x 1,1/4" x 32
13PKS-400440	5 pc. / 10 pc.	40 x 1/2" x 40
13PKS-400640	5 pc. / 10 pc.	40 x 1" x 40
13PKS-400740	5 pc. / 10 pc.	40 x 1,1/4" x 40
13PKS-500450	1 pc. / 4 pc.	50 x 1/2" x 50
13PKS-500550	1 pc. / 4 pc.	50 x 3/4" x 50
13PKS-500850	1 pc. / 4 pc.	50 x 1,1/2" x 50
13PKS-630463	1 pc. / 2 pc.	63 x 1/2" x 63
13PKS-631063	1 pc. / 2 pc.	63 x 2" x 63

### Type: 13PKS-N (CW602)



T-female branch  
T-binnendraad  
Pièce en T femelle  
T-IG

Article number	Bag / Box	Type
13PKS-260426-N	5 pc. / 30 pc.	26 x 1/2" x 26
13PKS-320432-N	5 pc. / 20 pc.	32 x 1/2" x 32
13PKS-320532-N	5 pc. / 15 pc.	32 x 3/4" x 32
13PKS-320632-N	5 pc. / 10 pc.	32 x 1" x 32
13PKS-320732-N	5 pc. / 10 pc.	32 x 1,1/4" x 32
13PKS-400440-N	5 pc. / 10 pc.	40 x 1/2" x 40
13PKS-400640-N	5 pc. / 10 pc.	40 x 1" x 40
13PKS-400740-N	5 pc. / 10 pc.	40 x 1,1/4" x 40
13PKS-500450-N	1 pc. / 4 pc.	50 x 1/2" x 50
13PKS-500550-N	1 pc. / 4 pc.	50 x 3/4" x 50
13PKS-500850-N	1 pc. / 4 pc.	50 x 1,1/2" x 50
13PKS-630463-N	1 pc. / 2 pc.	63 x 1/2" x 63
13PKS-631063-N	1 pc. / 2 pc.	63 x 2" x 63

## Type: 14PKS (CW617)



T-male branch  
T-buitendraad  
Pièce en T male  
T-AG

Article number	Bag / Box	Type
14PKS-320532	5 pc. / 15 pc.	32 x 3/4" x 32
14PKS-400640	5 pc. / 10 pc.	40 x 1" x 40
14PKS-400740	5 pc. / 10 pc.	40 x 1,1/4" x 40
14PKS-500850	1 pc. / 5 pc.	50 x 1,1/2" x 50
14PKS-631063	1 pc. / 2 pc.	63 x 2" x 63

## Type: 14PKS-N (CW602)



T-male branch  
T-buitendraad  
Pièce en T male  
T-AG

Article number	Bag / Box	Type
14PKS-320532-N	5 pc. / 15 pc.	32 x 3/4" x 32
14PKS-400640-N	5 pc. / 10 pc.	40 x 1" x 40
14PKS-400740-N	5 pc. / 10 pc.	40 x 1,1/4" x 40
14PKS-500850-N	1 pc. / 5 pc.	50 x 1,1/2" x 50
14PKS-631063-N	1 pc. / 2 pc.	63 x 2" x 63

## Type: 15PKS



Straight coupling  
Doorverbinder recht  
Manchon  
Kupplung

Article number	Bag / Box	Type
15PKS-2626	5 pc. / 50 pc.	26 x 26
15PKS-3232	5 pc. / 30 pc.	32 x 32
15PKS-4040	5 pc. / 25 pc.	40 x 40
15PKS-5050	1 pc. / 12 pc.	50 x 50
15PKS-6363	1 pc. / 9 pc.	63 x 63

## Type: 16PKS



Reducing coupling  
Verloopstuk  
Réduction  
Kupplung-reduziert

Article number	Bag / Box	Type
16PKS-3226	5 pc. / 40 pc.	32 x 26
16PKS-4026	5 pc. / 30 pc.	40 x 26
16PKS-4032	5 pc. / 25 pc.	40 x 32
16PKS-5032	1 pc. / 15 pc.	50 x 32
16PKS-5040	1 pc. / 15 pc.	50 x 40
16PKS-6340	1 pc. / 8 pc.	63 x 40
16PKS-6350	1 pc. / 8 pc.	63 x 50



## Type: 17PKS (CW617)



**Straight male adapter**  
**Recht aansluitstuk buitendraad**  
**Racord droit mâle**  
**Übergangsfitting AG**

Article number	Bag / Box	Type
17PKS-3206	10 pc. / 40 pc.	32 x 1"
17PKS-3207	5 pc. / 25 pc.	32 x 1,1/4"
17PKS-4006	5 pc. / 25 pc.	40 x 1"
17PKS-4007	5 pc. / 25 pc.	40 x 1,1/4"
17PKS-5008	1 pc. / 10 pc.	50 x 1,1/2"
17PKS-6310	1 pc. / 6 pc.	63 x 2"

## Type: 17PKS-N (CW602)



**Straight male adapter**  
**Recht aansluitstuk buitendraad**  
**Racord droit mâle**  
**Übergangsfitting AG**

Article number	Bag / Box	Type
17PKS-3206-N	10 pc. / 40 pc.	32 x 1"
17PKS-3207-N	5 pc. / 25 pc.	32 x 1,1/4"
17PKS-4006-N	5 pc. / 25 pc.	40 x 1"
17PKS-4007-N	5 pc. / 25 pc.	40 x 1,1/4"
17PKS-5008-N	1 pc. / 10 pc.	50 x 1,1/2"
17PKS-6310-N	1 pc. / 6 pc.	63 x 2"

## Type: 18PKS (CW617)



**Straight coupling**  
**Recht aansluitstuk binnendraad**  
**Racord droit femelle**  
**Übergangsfitting IG**

Article number	Bag / Box	Type
18PKS-2604	10 pc. / 50 pc.	26 x 1/2"
18PKS-2606	10 pc. / 40 pc.	26 x 1"
18PKS-3204	10 pc. / 40 pc.	32 x 1/2"
18PKS-3206	10 pc. / 40 pc.	32 x 1"
18PKS-3207	5 pc. / 25 pc.	32 x 1,1/4"
18PKS-4006	5 pc. / 25 pc.	40 x 1"
18PKS-4007	5 pc. / 25 pc.	40 x 1,1/4"
18PKS-5008	1 pc. / 10 pc.	50 x 1,1/2"
18PKS-6310	1 pc. / 6 pc.	63 x 2"

- 1
- 2
- 3
- 4
- 5
- 6
- 7
- 8
- 9
- 10
- 11



## D. PKS

### Type: 18PKS-N (CW602)



**Straight coupling**  
**Recht aansluitstuk binnendraad**  
**Racord droit femelle**  
**Übergangsfitting IG**

Article number	Bag / Box	Type
18PKS-2604-N	10 pc. / 50 pc.	26 x 1/2"
18PKS-2606-N	10 pc. / 40 pc.	26 x 1"
18PKS-3204-N	10 pc. / 40 pc.	32 x 1/2"
18PKS-3206-N	10 pc. / 40 pc.	32 x 1"
18PKS-3207-N	5 pc. / 25 pc.	32 x 1,1/4"
18PKS-4006-N	5 pc. / 25 pc.	40 x 1"
18PKS-4007-N	5 pc. / 25 pc.	40 x 1,1/4"
18PKS-5008-N	1 pc. / 10 pc.	50 x 1,1/2"
18PKS-6310-N	1 pc. / 6 pc.	63 x 2"

### Type: 27PKS



**45° bend**  
**Bocht 45°**  
**Coude 45°**  
**Winkel 45°**

Article number	Bag / Box	Type
27PKS-4040	2 pc. / 25 pc.	40 x 40
27PKS-5050	1 pc. / 10 pc.	50 x 50
27PKS-6363	1 pc. / 5 pc.	63 x 63

## E. SUPER SIZES



Detailed overview of Super Size possibilities

A = 75mm

B = 90-110mm

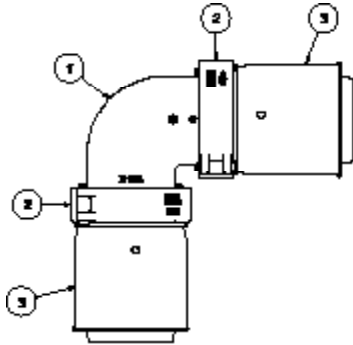

### 1PK

- 1 HNA or 1HNB
- 2 HNA or HNB
- 3 8HNA-PK40 or 8HNA-PK50 or 8HNA-PK63 or 8HNA-PK75 or 8HNB-PK90

### Example / Voorbeeld / Exemple / Beispiel

1PK-7575 = 1x 1HNA + 2xHNA + 2x 8HNA-PK75

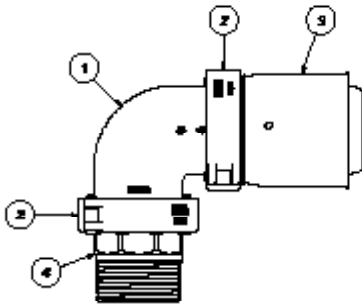

### 5PK / 6PK

- 1 1HNA or 1HNB
- 2 HNA or HNB
- 3 8HNA-PK75 or 8HNB-PK90
- 4 17HNA-10 or 17HNA-12 or 18HNA-06 or 18HNA-10 or 18HNA-12 or 18HNB-14

### Example / Voorbeeld / Exemple / Beispiel

5PK-7510 = 1x 1HNA + 2xHNA + 1x 8HNA-PK75 + 1x17HNA-10

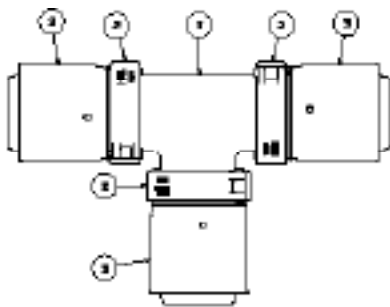

### 9PK / 10PK / 11PK / 12PK (75mm)

- 1 9HNA
- 2 HNA
- 3 8HNA-PK32 or 8HNA-PK40 or 8HNA-PK50 or 8HNA-PK63 or 8HNA-PK75

### Example / Voorbeeld / Exemple / Beispiel

9PK-757575 = 1x 9HNA + 3xHNA + 3x 8HNA-PK75

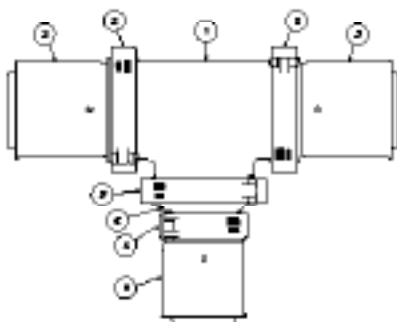

### 10PK / 11PK / 12PK (90mm)

- 1 9HNB
- 2 HNB
- 3 8HNB-PK90
- 4 16HNB
- 5 HNA
- 6 8HNA-PK32 or 8HNA-PK40 or 8HNA-PK50 or 8HNA-PK63 or 8HNA-PK75

### Example / Voorbeeld / Exemple / Beispiel

10PK-905090 = 1x 9HNB + 3x HNB + 2x 8HNB-PK90 + 1x 16HNB + 1xHNA + 8HNA-PK50

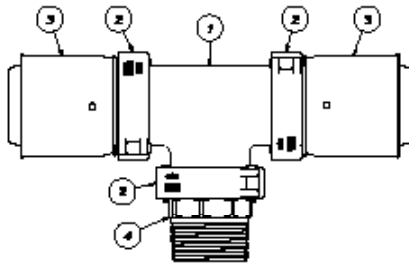

### 13PK / 14PK

- 1 9HNA or 9HNB
- 2 HNA or HNB
- 3 8HNA-PK75 or 8HNB-PK90
- 4 17HNA-10 or 17HNA-12 or 18HNA-06 or 18HNA-10 or 18HNA-12 or 18HNB-14

### Example / Voorbeeld / Exemple / Beispiel

13PK-750675 = 1x 9HNA + 3x HNA + 8HNA-PK75 + 18HNA-06

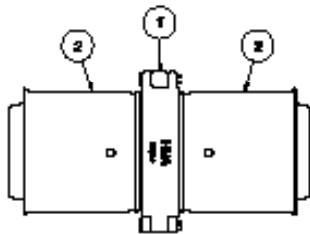

### 15PK / 16PK

- 1 HNA or HNB
- 2 8HNA-PK75 or 8HNB-PK90

### Example / Voorbeeld / Exemple / Beispiel

15PK-7575 = 1x HNA + 2x 8HNA-PK75

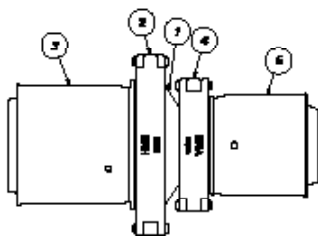

### 16PK

- 1 16HNBA
- 2 HNB
- 3 8HNB-PK90
- 4 HNA
- 5 8HNA-PK32 or 8HNA-PK40 or 8HNA-PK50 or 8HNA-PK63 or 8HNA-PK75

### Example / Voorbeeld / Exemple / Beispiel

16PK-9063 = 1x 16HNBA + 1x HNB + 1x 8HNB-PK90 + 1x HNA + 1x 8HNA-PK63

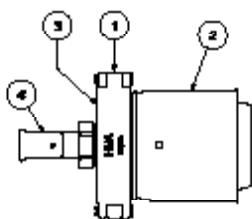

### 16PK-7516

- 1 HNA
- 2 8HNA-PK75
- 3 HNA-05
- 4 19P-1605 or 19P-1805 or 19P-2005 or 33P-1605 or 19SK-1605 or 19SK-2005

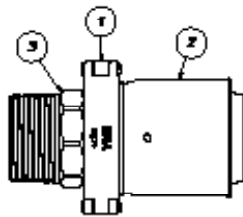

### 17PK / 18PK

- 1 HNA or HNB
- 2 8HNA-PK75 or 8HNB-PK90

#### Example / Voorbeeld / Exemple / Beispiel

18PK-7512 = 1x HNA + 1x 8HNA-PK75 + 1x 18HNA-12

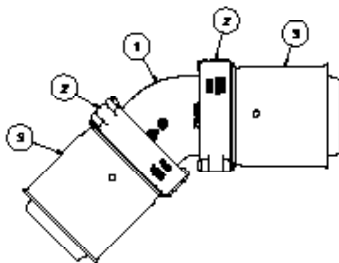

### 27PK

- 1 27HNA or 27HNB
- 2 HNA or HNB
- 3 8HNA-PK75 or 8HNB-PK90

#### Example / Voorbeeld / Exemple / Beispiel

27PK-9090 = 1x 27HNB + 2xHNB + 2x 8HNB-PK90

### SUPER SIZE ASSEMBLY

\*HN connection = click and lock connection  
\*PK connection = press connection



## E. SUPER SIZES

### Type: 1HN



Elbow 90°  
Knie 90°  
Coude 90°  
Winkel 90°

Article number	Bag / Box	Type
1HNA	1 pc. / 10 pc.	HNAXHNA
1HNB	1 pc. / 1 pc.	HNBxHNB

### Type: 9HN



T-piece  
T-stuk  
Pièce en T  
T-Stuck

Article number	Bag / Box	Type
9HNA	1 pc. / 7 pc.	HNAXHNAXHNA
9HNB	1 pc. / 1 pc.	HNBxHNBxHNB

### Type: 16HN



Reducing coupling  
Verloopstuk  
Réduction  
Kupplung-reduziert

Article number	Bag / Box	Type
16HNBA	1 pc. / 15 pc.	HNBxHNA

### Type: 27HN



Elbow 45°  
Bocht 45°  
Coude 45°  
Winkel 45°

Article number	Bag / Box	Type
27HNA	1 pc. / 15 pc.	HNAXHNA
27HNB	1 pc. / 1 pc.	HNBxHNB

### Type: 8HN



Pressfitting  
Persfitting  
Raccord à sertir  
Pressfitting

Article number	Bag / Box	Type
8HNA-PK32	1 pc. / 20 pc	HNAX32
8HNA-PK40	1 pc. / 20 pc.	HNAX40
8HNA-PK50	1 pc. / 15 pc.	HNAX50
8HNA-PK63	1 pc. / 12 pc.	HNAX63
8HNA-PK75	1 pc. / 12 pc.	HNAX75
8HNB-PK90	1 pc. / 4 pc.	HNBx90



## E. SUPER SIZES



### Type: HN



Bracket set  
Beugel set  
Support  
Bracket set

Article number	Bag / Box	Type
HNA	1 pc. / 1 pc.	
HNB	1 pc. / 1 pc.	

### Type: HN-PEN



Locking pin  
Beugelpin  
Goupille de verrouillage  
Sicherungsstift

Article number	Bag / Box	Type
HN-PEN	50 pc. / 50 pc.	

### Type: HN-U



Sealing ring  
Dichtingsring  
Anneau d'étanchéité  
Dichtungsring

Article number	Bag / Box	Type
HNA-U	10 pc. / 10 pc.	HNA
HNB-U	10 pc. / 10 pc.	HNB

### Type: 17HN (CW617)



Brass adapter male  
Messing adapter buitendraad  
Raccord en laiton mâle  
Brass adapter male

Article number	Bag / Box	Type
17HNA-10	1 pc. / 22 pc.	HNAx2"
17HNA-12	1 pc. / 18 pc.	HNAx2 1/2"

### Type: 17HN-N (CW602)



Brass adapter male  
Messing adapter buitendraad  
Raccord en laiton mâle  
Brass adapter male

Article number	Bag / Box	Type
17HNA-10-N	1 pc. / 22 pc.	HNAx2"
17HNA-12-N	1 pc. / 18 pc.	HNAx2 1/2"

- 1
- 2
- 3
- 4
- 5
- 6
- 7
- 8
- 9
- 10
- 11

## E. SUPER SIZES

### Type: 18HN (CW617)



Brass adapter female  
Messing adapter binnendraad  
Raccord en laiton femelle  
Brass adapter female

Article number	Bag / Box	Type
18HNA-06	1 pc. / 40 pc.	HNAx1"
18HNA-10	1 pc. / 27 pc.	HNAx2"
18HNA-12	1 pc. / 16 pc.	HNAx2 1/2"
18HNB-14	1 pc. / 12 pc.	HNBx3"

### Type: 18HN-N (CW602)



Brass adapter female  
Messing adapter binnendraad  
Raccord en laiton femelle  
Brass adapter female

Article number	Bag / Box	Type
18HNA-06-N	1 pc. / 40 pc.	HNAx1"
18HNA-10-N	1 pc. / 27 pc.	HNAx2"
18HNA-12-N	1 pc. / 16 pc.	HNAx2 1/2"
18HNB-14-N	1 pc. / 12 pc.	HNBx3"

### Type: HN-STOP



Stop end for Super Size range  
Eindstop voor Super Size gamma  
Bouchon d'arrêt Super Size  
Endkappe für das Sortiment Super Size

Article number	Bag / Box	Type
HNA-STOP	1 pc. / 90 pc.	HNA
HNB-STOP	1 pc. / 40 pc.	HNB

### Type: HNA-EK05



Adapter HNA x EK 3/4"  
Overgang HNA x EK 3/4"  
Réduction HNA x EK 3/4"  
Übergang HNA x EK 3/4"

Article number	Bag / Box	Type
HNA-EK05	1 pc. / 50 pc.	HNA x 3/4" EK



### Type: HNA-ECOLINE-SET



Basic set for Inliner  
 Basisset voor Inliner  
 Set de base pour Inliner  
 Grundsatz für Inliner

Article number	Bag / Box	Type
HNA-ECOLINE-SET	1 pc. / -	

#### Compostion:

- 1x 9HNA (T-piece)
- 4x HNA (Bracket set)
- 1x HNA-EK05 (Adapter HNA-EK)
- 1x HNA-INLB (Base plate for inliner)

The Henco ECO-line is an energy saving solution for recirculation loops, which limits heat loss between supply and return pipe.

A separate pipe for the circulation water is no longer required.

Designed on the Henco Super Size concept, it also combines modularity and easy installation.

### ONE CONCEPT FOR ALL DIMENSIONS FROM 40 UP TO 75MM

- Cost effective
- Easy installation
- Less space consumption
- Anti legionellosis

#### Necessary items to complete the ECOLINE installation \*

Article number	Description	Page
8HNA-PK...	Press fitting 40, 50, 63 or 75	56
100-MXC1620	Henco 1L PE-Xc 16x2 - 100m	-
19P-1605	Nickel plated press-fit adapter to eurocone 16x3/4"	79
19P-2005	Nickel plated press-fit adapter to eurocone 20x3/4"	79
33P-1605	Nickel plated press-fit adapter to eurocone 90°	83
19PK-1605	Press fit swivel to eurocone 16x3/4"	32
19PK-2005	Press fit swivel to eurocone 20x3/4"	32
19SK-1605	Push fitting with eurocone connection 16x3/4"	65
19SK-2005	Push fitting with eurocone connection 20x3/4"	65



\* To complete the Ecoline installation you need to have a circulator and thermostatic balancing valve (not in Henco range)



	<i>Page</i>
<b>A. SK</b>	<b>61</b>
<b>B. MANIFOLDS</b>	<b>67</b>



**Type: 1SK**



Elbow 90°  
Knie 90°  
Coude 90°  
Winkel 90°

Article number	Bag / Box	Type
1SK-1616	10 pc. / 70 pc.	16x16
1SK-2020	10 pc. / 50 pc.	20x20
1SK-2626	5 pc. / 40 pc.	26x26

**Type: 2SK**



Backplate elbow female  
Sanitair muurplaat binnendraad  
Culasse pour sanitaire femelle  
Sanitär Wandscheibe IG

Article number	Bag / Box	Type
2SK-1604BP*	10 pc. / 40 pc.	16x1/2" (56 mm)
2SK-2004BP*	10 pc. / 40 pc.	20X1/2" (56 mm)
2SK-2005	10 pc. / 30 pc.	20X3/4" (56 mm)
2SK-2605	5 pc. / 20 pc.	26X3/4" (56 mm)

\* With black plug BP04 1/2"

**Type: 2S**



Backplate elbow female, short model  
Sanitair muurplaat binnendraad kort  
Culasse pour sanitaire femelle, modèle court  
Sanitär Wandscheibe IG, kurzes Modell

Article number	Bag / Box	Type
2S-1604K	10 pc. / 50 pc.	16x1/2" (43 mm)

**Type: 3SK**



Double backplate elbow female, short model  
Dubbel sanitair muurplaat binnendraad, laag  
Culasse double pour sanitaire, modèle court  
Sanitär Wandscheibe doppelt IG, kurzes Modell

Article number	Bag / Box	Type
3SK-160416BP *	10 pc. / 30 pc.	16X1/2" (40 mm)
3SK-200420BP *	10 pc. / 30 pc.	20X1/2" (40 mm)

\* With black plug BP04 1/2"

- 1
- 2
- 3
- 4
- 5
- 6
- 7
- 8
- 9
- 10
- 11



## A. SK

### Type: 5SK



PK-TOOL p 170

Bend 90° male adapter  
 Knie 90° buitendraad  
 Coude 90° mâle  
 Winkel 90° AG

Article number	Bag / Box	Type
5SK-1604	10 pc. / 60 pc.	16X1/2"
5SK-2004	10 pc. / 50 pc.	20X1/2"
5SK-2005	10 pc. / 40 pc.	20X3/4"
5SK-2605	5 pc. / 30 pc.	26X3/4"

### Type: 6SK



PK-TOOL p 170

Bend 90° female adapter  
 Knie 90° binnendraad  
 Coude 90° femelle  
 Winkel 90° IG

Article number	Bag / Box	Type
6SK-1604BP *	10 pc. / 60 pc.	16X1/2"
6SK-2004BP *	10 pc. / 60 pc.	20X1/2"
6SK-2005	10 pc. / 30 pc.	20X3/4"
6SK-2605	10 pc. / 30 pc.	26X3/4"

\* With black plug BP04 1/2"

### Type: 9SK



T-piece  
 T-stuk  
 Pièce en T  
 T-Stuck

Article number	Bag / Box	Type
9SK-161616	10 pc. / 40 pc.	16x16x16
9SK-202020	10 pc. / 30 pc.	20x20x20
9SK-262626	5 pc. / 20 pc.	26x26x26

### Type: 10SK



T-reduced centre  
 T-verlopend  
 Pièce en T réduit  
 T-reduziert

Article number	Bag / Box	Type
10SK-201620	10 pc. / 40 pc.	20x16x20
10SK-261626	5 pc. / 25 pc.	26x16x26
10SK-262026	5 pc. / 20 pc.	26x20x26



- 1
- 2
- 3
- 4
- 5
- 6
- 7
- 8
- 9
- 10
- 11

**Type: 11SK**



T-branch and line reduced  
 T-2X verlopend  
 Pièce en T 2X réduit  
 T-2X rezuiziert

Article number	Bag / Box	Type
11SK-201616	10 pc. / 40 pc.	20x16x16
11SK-202016	10 pc. / 30 pc.	20x20x16
11SK-261620	5 pc. / 25 pc.	26x16x20
11SK-262016	5 pc. / 25 pc.	26x20x16
11SK-262020	5 pc. / 25 pc.	26x20x20
11SK-262616	5 pc. / 25 pc.	26x26x16
11SK-262620	5 pc. / 20 pc.	26x26x20

**Type: 12SK**



T-enlarged branch  
 T-vergroot  
 Pièce en T agrandi  
 T-erweitert

Article number	Bag / Box	Type
12SK-162016	10 pc. / 40 pc.	16x20x16
12SK-202620	5 pc. / 30 pc.	20x26x20

**Type: 13SK**



PK-TOOL p 170

T-female centre  
 T-binnendraad  
 Pièce en T femelle  
 T-IG

Article number	Bag / Box	Type
13SK-160416BP *	10 pc. / 40 pc.	16x1/2"x16
13SK-200420BP *	10 pc. / 30 pc.	20x1/2"x20
13SK-200520	10 pc. / 30 pc.	20x3/4"x20
13SK-260420BP *	5 pc. / 20 pc.	26x1/2"x20
13SK-260426BP *	5 pc. / 20 pc.	26x1/2"x26
13SK-260526	5 pc. / 20 pc.	26x3/4"x26

\* With black plug BP04 1/2"

**Type: 14SK**



PK-TOOL p 170

T-male centre  
 T-buitendraad  
 Pièce en T mâle  
 T-AG

Article number	Bag / Box	Type
14SK-160416	10 pc. / 40 pc.	16x1/2"x16
14SK-200420	10 pc. / 30 pc.	20x1/2"x20
14SK-260426	5 pc. / 20 pc.	26x1/2"x26



## A. SK

1

### Type: 15SK

2

3

4

5

6

7



**Straight coupling**  
**Doorverbinder recht**  
**Manchon**  
**Kupplung**

Article number	Bag / Box	Type
15SK-1616	10 pc. / 70 pc.	16x16
15SK-2020	10 pc. / 60 pc.	20x20
15SK-2626	5 pc. / 30 pc.	26x26

8

### Type: 16SK

9

10

11



**Reducing coupling**  
**Verloopstuk**  
**Réduction**  
**Kupplung-reduziert**

Article number	Bag / Box	Type
16SK-2016	10 pc. / 80 pc.	20x16
16SK-2616	10 pc. / 50 pc.	26x16
16SK-2620	10 pc. / 40 pc.	26x20

### Type: 17SK



PK-TOOL p 170

**Straight male adapter**  
**Recht aansluitstuk buitendraad / Puntstuk**  
**Raccord droit mâle**  
**Übergangsfitting AG**

Article number	Bag / Box	Type
17SK-1603	10 pc. / 80 pc.	16x3/8"
17SK-1604	10 pc. / 80 pc.	16x1/2"
17SK-2004	10 pc. / 60 pc.	20x1/2"
17SK-2005	10 pc. / 60 pc.	20x3/4"
17SK-2605	10 pc. / 40 pc.	26x3/4"
17SK-2606	10 pc. / 40 pc.	26x1"

### Type: 18SK



PK-TOOL p 170

**Straight female adapter**  
**Recht aansluitstuk binnendraad / Schroefbus**  
**Raccord droit femelle**  
**Übergangsfitting IG**

Article number	Bag / Box	Type
18SK-1604	10 pc. / 80 pc.	16x1/2"
18SK-2004	10 pc. / 80 pc.	20x1/2"
18SK-2005	10 pc. / 60 pc.	20x3/4"
18SK-2605	10 pc. / 50 pc.	26x3/4"
18SK-2606	10 pc. / 40 pc.	26x1"





## Type: 17SKS



**Straight nipple male (brass)**  
**Recht aansluitstuk buitendraad (messing)**  
**Raccord droit mâle (laiton)**  
**Übergangsfitting AG (Messing)**

Article number	Bag / Box	Type
17SKS-2004	5 pc. / 150 pc.	20x1/2"
17SKS-2005	5 pc. / 150 pc.	20x3/4"
17SKS-2604	5 pc. / 100 pc.	26x1/2"
17SKS-2605	5 pc. / 100 pc.	26x3/4"

*Applicable with HENCO Vision fittings & manifolds*

## Type: 18SKS



**Straight nipple female (brass)**  
**Recht aansluitstuk binnendraad (messing)**  
**Raccord droit femelle (laiton)**  
**Übergangsfitting IG (Messing)**

Article number	Bag / Box	Type
18SKS-2004	5 pc. / 150 pc.	20x1/2"
18SKS-2005	5 pc. / 100 pc.	20x3/4"
18SKS-2604	5 pc. / 100 pc.	26x1/2"
18SKS-2605	5 pc. / 80 pc.	26x3/4"

*Applicable with HENCO Vision fittings & manifolds*

## Type: 19SK



**Push fitting with eurocone connection**  
**Steekkoppeling met euroconus-aansluiting**  
**Raccord push fit avec eurocone**  
**Steckkupplung mit Eurokonus**

Article number	Bag / Box	Type
19SK-1605	10 pc. / 80 pc.	16x3/4"
19SK-2005	10 pc. / 80 pc.	20x3/4"

## Type: 26SK



**Push fitting with swivel and flat sealing**  
**Steekkoppeling met wartel en vlakke dichting**  
**Raccord push fit avec raccord ecrou etanchéité plate**  
**Steckkupplung mit Drehbar und flach Versiegelung**

Article number	Bag / Box	Type
26SK-1605	10 pc. / 80 pc.	16x3/4"
26SK-2005	10 pc. / 80 pc.	20x3/4"

## Type: SK-PIPESTOP



Stop end for pipe  
Eindstop voor buis  
Bouchon pour tube  
Endkappe für Rohre

Article number	Bag / Box	Type
SK-PIPESTOP16	10 pc. / 120 pc.	16
SK-PIPESTOP20	10 pc. / 80 pc.	20
SK-PIPESTOP26	10 pc. / 80 pc.	26

## Type: SK-STOPCLIP



Reusable stop and clip for push fit connection  
Herbruikbare stop en clip passend in een steekkoppeling  
Bouchon et clip réutilisables pour connection push fit  
Stopfen und clip für Steckanschluss, wieder verwendbar

Article number	Bag / Box	Type
SK-STOPCLIP16	10 pc. / 120 pc.	16
SK-STOPCLIP20	10 pc. / 100 pc.	20
SK-STOPCLIP26	10 pc. / 80 pc.	26

## Type: VISION SET



Vision revision set  
Vision revisie set  
Set de révision Vision  
Vision set

Article number	Bag / Box	Type
VISION SET 16	1 pc. / 100 pc.	16
VISION SET 20	1 pc. / 90 pc.	20
VISION SET 26	1 pc. / 80 pc.	26

## Type: VISION KEY



Vision disassembly key  
Vision demontage sleutel  
Clé de démontage Vision  
Vision Entriegelungsschlüssel

Article number	Bag / Box	Type
VISION-KEY16	1 pc. / 200 pc.	16
VISION-KEY20	1 pc. / 200 pc.	20
VISION-KEY26	1 pc. / 200 pc.	26

## B. MANIFOLDS



### Type: VSK-1616



Extension or body for manifold, two SK connections Ø16  
Verlengstuk of basis voor verdeler, twee SK-aansluitingen Ø16  
Complément ou base collecteur, deux sorties SK Ø16  
Erweiterung oder Basiskörper für Verteiler, zwei SK-Anschlüssen Ø16

Article number	Bag / Box	Type
VSK-1616	1 pc. / 14 pc.	1616

### Type: VSK-161616



Extension or body for manifold, three SK connections Ø16  
Verlengstuk of basis voor verdeler, drie SK-aansluitingen Ø16  
Complément ou base collecteur, trois sorties SK Ø16  
Erweiterung oder Basiskörper für Verteiler, drei SK-Anschlüssen Ø16

Article number	Bag / Box	Type
VSK-161616	1 pc. / 14 pc.	161616

### Type: VSKEK-0502



Extension or body for manifold, two eurocone connections  
Verlengstuk of basis voor verdeler, twee euroconus-aansluitingen  
Complément ou base collecteur, deux sorties eurocone  
Erweiterung oder Basiskörper für Verteiler, zwei Eurokonus-Anschlüssen

Article number	Bag / Box	Type
VSKEK-0502	10 pc. / 30 pc.	2x3/4"

### Type: VSKEK-0503



Extension or body for manifold, three eurocone connections  
Verlengstuk of basis voor verdeler, drie euroconus-aansluitingen  
Complément ou base collecteur, trois sorties eurocone  
Erweiterung oder Basiskörper für Verteiler, drei Eurokonus-Anschlüssen

Article number	Bag / Box	Type
VSKEK-0503	10 pc. / 30 pc.	3x3/4"

## B. MANIFOLDS

### Type: 19SK



Push fitting with eurocone connection  
 Steekkoppeling met euroconus-aansluiting  
 Raccord push fit avec eurocone  
 Steckkupplung mit Eurokonus

Article number	Bag / Box	Type
19SK-1605	10 pc. / 80 pc.	16x3/4"
19SK-2005	10 pc. / 80 pc.	20x3/4"

### Type: VVSK



Straight entry piece  
 Voeding voor verdeler  
 Départ collecteur  
 Eingang für Verteiler

Article number	Bag / Box	Type
VVSK-20	10 pc. / 80 pc.	20
VVSK-26	10 pc. / 80 pc.	26

### Type: VVSK-TM



T-piece for supply for Vision manifold  
 Aanvoer T-stuk voor Vision manifold  
 Départ pièce en T collecteur Vision  
 T-Stück für Vorlauf für Vision Verteiler

Article number	Bag / Box	Type
VVSK-T20M20	10 pc. / 30 pc.	20-20
VVSK-T26M26	5 pc. / 20 pc.	26-26

### Type: 17SKS



Straight nipple male (brass)  
 Recht aansluitstuk buitendraad (messing)  
 Raccord droit mâle (laition)  
 Übergangsfitting AG (Messing)

Article number	Bag / Box	Type
17SKS-2004	5 pc. / 150 pc.	20 x 1/2"
17SKS-2005	5 pc. / 150 pc.	20 x 3/4"
17SKS-2604	5 pc. / 100 pc.	26 x 1/2"
17SKS-2605	5 pc. / 100 pc.	26 x 3/4"

*Applicable with HENCO Vision fittings & manifolds*

## B. MANIFOLDS



### Type: 18SKS



Straight nipple female (brass)  
Recht aansluitstuk binnendraad (messing)  
Raccord droit femelle (laiton)  
Übergangsfitting IG (Messing)

Article number	Bag / Box	Type
18SKS-2004	5 pc. / 150 pc.	20 x 1/2"
18SKS-2005	5 pc. / 100 pc.	20 x 3/4"
18SKS-2604	5 pc. / 100 pc.	26 x 1/2"
18SKS-2605	5 pc. / 80 pc.	26 x 3/4"

*Applicable with HENCO Vision fittings & manifolds*

### Type: VVSK-90



Elbow 90° for manifold  
Knie 90° voor verdeler  
Coude 90° pour collecteur  
Winkel 90° für Verteiler

Article number	Bag / Box	Type
VVSK-20-90	10 pc. / 70 pc.	20-90
VVSK-26-90	10 pc. / 50 pc.	26-90

### Type: VVSK-T



T for manifold  
T voor verdeler  
Piece en T pour collecteur  
T für Verteiler

Article number	Bag / Box	Type
VVSK-T202020	10 pc. / 40 pc.	20-20-20
VVSK-T262626	10 pc. / 20 pc.	26-26-26

### Type: VS-ENDCAP



Endcap female for manifold  
Eindkap binnendraad voor verdeler  
Bouchon femelle pour collecteur  
Endkappe IG für Verteiler

Article number	Bag / Box	Type
VS-ENDCAP	10 pc. / 180 pc.	F

## B. MANIFOLDS

### Type: VS-ENDCAP-M



End plugmale for manifold  
Eindstop buitendraad voor verdeler  
Bouchon mâle pour collecteur  
Endkappe AG für Verteiler

Article number	Bag / Box	Type
VS-ENDCAP-M	10 pc. / 150 pc.	M

### Type: ENDCAP-EK05



Eurocone endcap 3/4" white  
Euroconus-eindkap 3/4" wit  
Eurocone bouchon 3/4" blanc  
Eurokonus Endkappe 3/4" Weiss

Article number	Bag / Box	Type
ENDCAP-EK05	10 pc. / 200 pc.	3/4"

### Type: VDSK



Straight female adapter for manifold or manifold extension  
Doorverbinder voor montage op verdeler of verlengstuk  
Manchon pour bout de collecteur  
Ausgang für Verteiler

Article number	Bag / Box	Type
VDSK-20	10 pc. / 80 pc.	20
VDSK-26	10 pc. / 60 pc.	26

### Type: SK-STOPCLIP



Reusable stop and clip for push fit connection  
Herbruikbare stop en clip passend in een steekkoppeling  
Bouchon et clip réutilisables pour connection push fit  
Stopfen und clip für Steckanschluss, wieder verwendbar

Article number	Bag / Box	Type
SK-STOPCLIP16	10 pc. / 120 pc.	16
SK-STOPCLIP20	10 pc. / 100 pc.	20
SK-STOPCLIP26	10 pc. / 80 pc.	26

### Type: SK-B05



Bracket for Vision manifolds  
Montagebeugel voor Vision verdelers  
Double support pour collecteurs Vision  
Halter für Vision Verteiler

Article number	pc / Box	Typ
SK-B05	1 pc. / 200 pc.	B05



## POSSIBLE COMBINATIONS

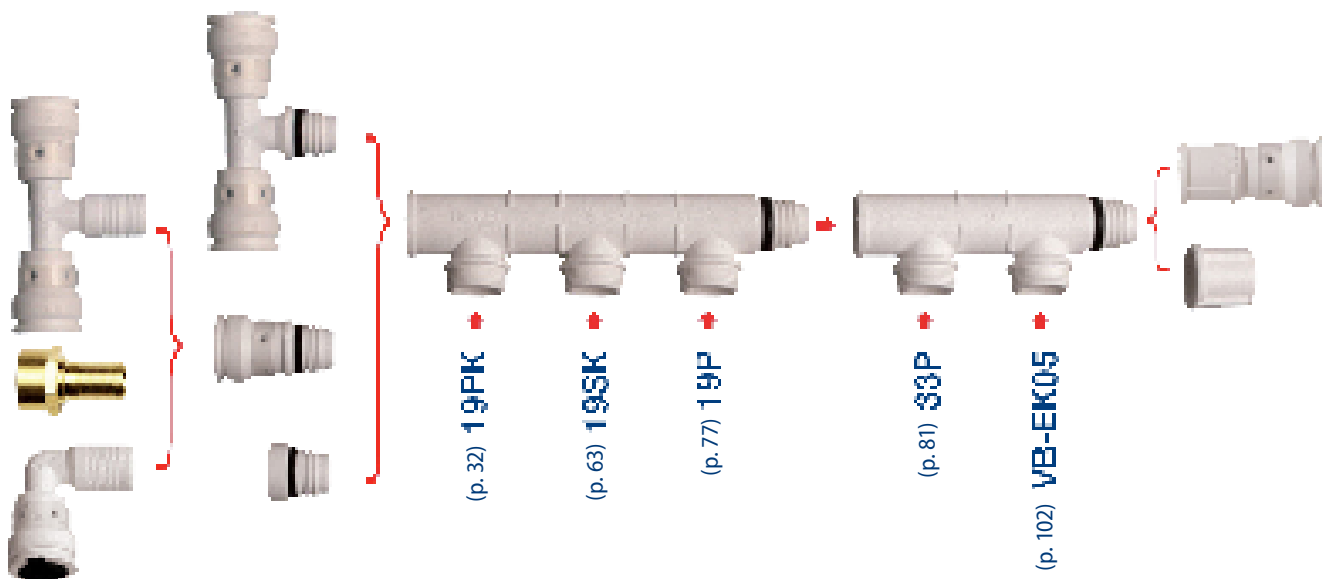

(p. 32) **19PK**

(p. 63) **19SK**

(p. 77) **19P**

(p. 81) **33P**

(p. 102) **VB-EK05**

- 1
- 2
- 3
- 4
- 5
- 6
- 7
- 8
- 9
- 10
- 11

### Type: 41S



**Brass Vision coupling with valve F-connection**  
**Messing Vision koppeling met F-aansluiting**  
**Connecteur Vision F**  
**Vision Fittung mit F-Verbindung**

Article number	Bag / Box	Typ
41S-20	10 pc. / 60 pc.	20
41S-26	10 pc. / 80 pc.	26

### Type: 41SKS



**Connection Vision coupling with valve F-connection**  
**Aansluitstuk Vision koppeling met F-aansluiting**  
**Raccord Vision Connecteur Vision F**  
**Messing Übergang Vision Fittung mit F-Verbindung**

Article number	Bag / Box	Typ
41SKS-20	10 pc. / 80 pc.	20
41SKS-26	10 pc. / 80 pc.	26

BA-F41 (p. 109)



# BRASS PRESS FITTINGS - MESSING PERSKOPPELINGEN - RACCORDS À SERTIR EN LAITON - MESSING PRESSFITTINGE



	<i>Page</i>
<i>A. P</i>	<i>73</i>
<i>B. PG</i>	<i>87</i>





**Type: 1P**



Elbow 90°  
Knie 90°  
Coude 90°  
Winkel 90°

Article number	Bag / Box	Type
1P-1414	10 pc. / 150 pc.	14x14
1P-1616	10 pc. / 150 pc.	16x16
1P-1818	10 pc. / 100 pc.	18x18
1P-2020	10 pc. / 80 pc.	20x20
1P-2626	5 pc. / 50 pc.	26x26
1P-3232	5 pc. / 50 pc.	32x32

**Type: 2P**



Backplate elbow female  
Sanitair muurplaat binnendraad  
Culasse pour sanitaire femelle  
Sanitär Wandscheibe IG

Article number	Bag / Box	Type
2P-1604	10 pc. / 50 pc.	16x1/2" (52 mm)
2P-1804	10 pc. / 50 pc.	18x1/2" (52 mm)
2P-2004	10 pc. / 50 pc.	20x1/2" (52 mm)
2P-2005	10 pc. / 50 pc.	20x3/4" (52 mm)
2P-2605	5 pc. / 50 pc.	26x3/4" (52 mm)

**Type: 2P-K**



Backplate elbow female, short model  
Sanitair muurplaat binnendraad, laag  
Culasse pour sanitaire femelle, modèle court  
Sanitär Wandscheibe IG, kurzes Modell

Article number	Bag / Box	Type
2P-1404K	10 pc. / 50 pc.	14x1/2" (35 mm)
2P-1604K	10 pc. / 50 pc.	16x1/2" (35 mm)

Accessory 2P & 2P-K: galvanised bracket plate - see page 172



PLP-P-PK



PLF-P-PK

**Type: 3P**



Double backplate elbow female  
Sanitaire muurplaat binnendraad, dubbel  
Culasse double pour sanitaire femelle  
Sanitär Wandscheibe doppelt IG

Article number	Bag / Box	Type
3P-160416	10 pc. / 40 pc.	16x1/2"x16 (52 mm)
3P-200420	10 pc. / 40 pc.	20x1/2"x20 (52 mm)

## Type: 3P-VK



Double backplate female (flow), short model  
 Doorstroom muurplaat binnendraad, laag  
 Culasse double femelle (écoulement), modèle court  
 Wandscheibe doppelt IG (Fluss), kurzes Modell

Article number	Bag / Box	Type
3P-160416VK	5 pc. / 20 pc.	16x1/2"x16 (40 mm)
3P-200420VK	5 pc. / 20 pc.	20x1/2"x20 (40 mm)

## Type: 4P



Backplate elbow female, extended model  
 Sanitair muurplaat binnendraad, hoog  
 Culasse pour sanitaire femelle, modèle long  
 Sanitär Wandscheibe IG, langes Modell

Article number	Bag / Box	Type
4P-1604	10 pc. / 40 pc.	16x1/2" (78 mm)
4P-1804	10 pc. / 40 pc.	18x1/2" (78 mm)
4P-2004	10 pc. / 40 pc.	20x1/2" (78 mm)

Accessory 3P-VK & 4P : galvanised bracket plate - see page 172



PLP-P-PK



PLF-P-PK

## Type: 5P



Bend 90° male adapter  
 Knie 90° buitendraad  
 Coude 90° mâle  
 Winkel 90° AG

Article number	Bag / Box	Type
5P-1404	10 pc. / 150 pc.	14x1/2"
5P-1603	10 pc. / 150 pc.	16x3/8"
5P-1603DZR *	10 pc. / 150 pc.	16x3/8"
5P-1604	10 pc. / 150 pc.	16x1/2"
5P-1604DZR *	10 pc. / 150 pc.	16x1/2"
5P-1804	10 pc. / 120 pc.	18x1/2"
5P-2004	10 pc. / 100 pc.	20x1/2"
5P-2005	10 pc. / 80 pc.	20x3/4"
5P-2605	10 pc. / 60 pc.	26x3/4"
5P-3206 **	5 pc. / 25 pc.	32x1"

\* DZR = Brass alloy CW602N"

\*\*TILL EXHAUSTION OF STOCK



## Type: 6P



Bend 90° female adapter  
Knie 90° binnendraad  
Coude 90° femelle  
Winkel 90° IG

Article number	Bag / Box	Type
6P-1404	10 pc. / 120 pc.	14x1/2"
6P-1604	10 pc. / 120 pc.	16x1/2"
6P-1804	10 pc. / 120 pc.	18x1/2"
6P-2004	10 pc. / 120 pc.	20x1/2"
6P-2005	10 pc. / 50 pc.	20x3/4"
6P-2605	5 pc. / 50 pc.	26x3/4"

\*TILL EXHAUSTION OF STOCK

## Type: 7P



Backplate elbow male  
Sanitair muurplaat buitendraad met binnendraad 1/2"  
Culasse pour sanitaire mâle  
Sanitär Wandscheibe AG

Article number	Bag / Box	Type
7P-1605	10 pc. / 30 pc.	16x3/4" (78 mm)
7P-2005	10 pc. / 30 pc.	20x3/4" (78 mm)
7P-1605K	5 pc. / 30 pc.	16x3/4" (60 mm)
7P-1605L	5 pc. / 30 pc.	16x3/4" (70 mm)

## Type: 8P



Sanitary adapter female  
Sanitair aansluitstuk met binnendraad  
Culasse pour sanitaire femelle  
UP-Spülkastenwinkel

Article number	Bag / Box	Type
8P-1604	10 pc. / 50 pc.	16x1/2"

## Type: 9P



T-piece  
T-stuk  
Piece en T  
T-Stück

Article number	Bag / Box	Type
9P-141414	10 pc. / 100 pc.	14x14x14
9P-161616	10 pc. / 60 pc.	16x16x16
9P-181818	10 pc. / 60 pc.	18x18x18
9P-202020	10 pc. / 50 pc.	20x20x20
9P-262626	5 pc. / 30 pc.	26x26x26
9P-323232 *	1 pc. / 20 pc.	32x32x32

\*TILL EXHAUSTION OF STOCK

## Type: 10P



T-reduced centre

T-verlopend

Pièce en T réduit

T-reduziert

Article number	Bag / Box	Type
10P-161416	10 pc. / 50 pc.	16x14x16
10P-181618	10 pc. / 60 pc.	18x16x18
10P-201620	10 pc. / 50 pc.	20x16x20
10P-201820	10 pc. / 50 pc.	20x18x20
10P-261626	5 pc. / 30 pc.	26x16x26
10P-261826	5 pc. / 30 pc.	26x18x26
10P-262026	5 pc. / 30 pc.	26x20x26
10P-321632 *	5 pc. / 20 pc.	32x16x32
10P-322032 *	5 pc. / 20 pc.	32x20x32
10P-322632 *	5 pc. / 20 pc.	32x26x32

\*TILL EXHAUSTION OF STOCK

## Type: 11P



T-branch and line reduced

T-2X verlopend

Pièce en T 2X réduit

T-2X reduziert

Article number	Bag / Box	Type
11P-181616	10 pc. / 50 pc.	18x16x16
11P-201616	10 pc. / 50 pc.	20x16x16
11P-201818	10 pc. / 50 pc.	20x18x18
11P-202016	10 pc. / 50 pc.	20x20x16
11P-261620	5 pc. / 30 pc.	26x16x20
11P-262020	5 pc. / 30 pc.	26x20x20
11P-262616	5 pc. / 30 pc.	26x26x16
11P-262620	5 pc. / 30 pc.	26x26x20
11P-322026 *	5 pc. / 20 pc.	32x20x26
11P-322626 *	5 pc. / 20 pc.	32x26x26

\*TILL EXHAUSTION OF STOCK

## Type: 12P



T-enlarged branch

T-vergroot

Pièce en T agrandi

T-erweitert

Article number	Bag / Box	Type
12P-161816	10 pc. / 60 pc.	16x18x16
12P-162016	10 pc. / 60 pc.	16x20x16
12P-202620	5 pc. / 30 pc.	20x26x20
12P-263226 *	5 pc. / 20 pc.	26x32x26

\*TILL EXHAUSTION OF STOCK



## Type: 13P



T-with female branch

T-binnendraad

Pièce en T femelle

T-IG

Article number	Bag / Box	Type
13P-160416	10 pc. / 60 pc.	16x1/2"x16
13P-200420	10 pc. / 50 pc.	20x1/2"x20
13P-200520	10 pc. / 30 pc.	20x3/4"x20
13P-260426	5 pc. / 30 pc.	26x1/2"x26
13P-260526	5 pc. / 30 pc.	26x3/4"x26
13P-320532 *	5 pc. / 20 pc.	32x3/4"x32
13P-320632 *	5 pc. / 20 pc.	32x1"x32
13P-320732 *	5 pc. / 20 pc.	32x1 1/4"x32

\*TILL EXHAUSTION OF STOCK

## Type: 14P



T-with male branch

T-buitendraad

Pièce en T mâle

T-AG

Article number	Bag / Box	Type
14P-160416	10 pc. / 60 pc.	16x1/2"x16
14P-200420	10 pc. / 60 pc.	20x1/2"x20
14P-200520	5 pc. / 30 pc.	20x3/4"x20
14P-260426	5 pc. / 30 pc.	26x1/2"x26
14P-260526	5 pc. / 30 pc.	26x3/4"x26
14P-260626	5 pc. / 30 pc.	26x1"x26
14P-320532 *	5 pc. / 20 pc.	32x3/4"x32
14P-320632 *	5 pc. / 20 pc.	32x1"x32

\*TILL EXHAUSTION OF STOCK

## Type: 15P



Straight coupling

Doorverbinder recht / perssok

Manchon

Kupplung

Article number	Bag / Box	Type
15P-1414	10 pc. / 200 pc.	14x14
15P-1616	10 pc. / 200 pc.	16x16
15P-1818	10 pc. / 150 pc.	18x18
15P-2020	10 pc. / 140 pc.	20x20
15P-2626	5 pc. / 80 pc.	26x26
15P-3232	5 pc. / 50 pc.	32x32

## Type: 16P



Reducing coupling  
Verloopstuk  
Réduction  
Kupplung-reduziert

Article number	Bag / Box	Type
16P-1614	10 pc. / 150 pc.	16x14
16P-1816	10 pc. / 150 pc.	18x16
16P-2016	10 pc. / 150 pc.	20x16
16P-2018	10 pc. / 150 pc.	20x18
16P-2616	5 pc. / 100 pc.	26x16
16P-2620	5 pc. / 80 pc.	26x20
16P-3216 *	5 pc. / 60 pc.	32x16
16P-3220 *	5 pc. / 60 pc.	32x20
16P-3226	5 pc. / 60 pc.	32x26

*\*TILL EXHAUSTION OF STOCK*

## Type: 17P



Straight male adapter  
Recht aansluitstuk buitendraad / Puntstuk  
Raccord droit mâle  
Übergangsfitting AG

Article number	Bag / Box	Type
17P-1403	10 pc. / 250 pc.	14x3/8"
17P-1404	10 pc. / 150 pc.	14x1/2"
17P-1603	10 pc. / 150 pc.	16x3/8"
17P-1603DZR	10 pc. / 150 pc.	16x3/8"
17P-1604	10 pc. / 150 pc.	16x1/2"
17P-1604DZR	10 pc. / 150 pc.	16x1/2"
17P-1605	10 pc. / 150 pc.	16x3/4"
17P-1804	10 pc. / 150 pc.	18x1/2"
17P-1805	10 pc. / 150 pc.	18x3/4"
17P-2004	10 pc. / 150 pc.	20x1/2"
17P-2005	10 pc. / 150 pc.	20x3/4"
17P-2605	5 pc. / 80 pc.	26x3/4"
17P-2606	5 pc. / 80 pc.	26x1"
17P-3206	5 pc. / 50 pc.	32x1"
17P-3207 *	5 pc. / 40 pc.	32x1 1/4"

*\*TILL EXHAUSTION OF STOCK*

**Type: 18P**

**Straight female adapter**  
**Recht aansluitstuk binnendraad / Schroefbus**  
**Raccord droit femelle**  
**Übergangsfitting IG**

Article number	Bag / Box	Type
18P-1404	10 pc. / 200 pc.	14x1/2"
18P-1604	10 pc. / 150 pc.	16x1/2"
18P-1804	10 pc. / 120 pc.	18x1/2"
18P-1805	10 pc. / 100 pc.	18x3/4"
18P-2004	10 pc. / 100 pc.	20x1/2"
18P-2005	10 pc. / 100 pc.	20x3/4"
18P-2605	5 pc. / 80 pc.	26x3/4"
18P-2606	5 pc. / 70 pc.	26x1"
18P-3206	5 pc. / 50 pc.	32x1"
18P-3207 *	5 pc. / 30 pc.	32x1 1/4"

*\*TILL EXHAUSTION OF STOCK*

**Type: 19P**

**Press-fit adapter to eurocone**  
**Aansluiting met wartel en euroconus-koppeling**  
**Raccordement avec raccord à visser eurocone**  
**Anschlussverschraubung mit Eurokonus**

Article number	Bag / Box	Type
19P-1405	10 pc. / 150 pc.	14x3/4"
19P-1605	10 pc. / 150 pc.	16x3/4"
19P-1805	10 pc. / 150 pc.	18x3/4"
19P-2005	10 pc. / 140 pc.	20x3/4"

**Type: 20P**

**Fitting short model for plint-heating**  
**Fitting laag model voor plintverwarming**  
**Raccord pour montage dans la plinthe**  
**Sockelleisten- Anschluss-Set kurz von unten**

Article number	Bag / Box	Type
20P-1604	2 pc. / 10 pc.	16x1/2"

*TILL EXHAUSTION OF STOCK*

**Type: 21P**

**Elbow for plinth-heating chrome-plated**  
**Bocht voor plintverwarming verchromd**  
**Equerre chromée pour montage dans la plinthe**  
**Sockelleistenanschluss Winkel verchromt**

Article number	Bag / Box	Type
21P-1504	2 pc. / 40 pc.	15x1/2"

## Type: 22P



T, radiator connection nickel-plated 300 mm copper pipe Ø15  
 Radiatoraansluiting T vernikkeld met 300 mm koperbuis Ø15  
 T, alimentation radiateur nickelé 300 mm tube de cuivre Ø15  
 Heizkörperanschluss T vernickelt 300 mm Kupferrohr Ø15

Article number	Bag / Box	Type
22P-1604	2 pc. / 50 pc.	16x15Cux16
22P-2004	2 pc. / 30 pc.	20x15Cux20

## Type: 24P



Radiator connection nickel-plated 300 mm copper pipe Ø15  
 Radiatoraansluitbocht vernikkeld met 300 mm koperbuis Ø15  
 Alimentation radiateur nickelé 300 mm tube de cuivre Ø15  
 Heizkörperanschluss vernickelt 300 mm Kupferrohr Ø15

Article number	Bag / Box	Type
24P-1604	2 pc. / 50 pc.	16x15Cu
24P-2004	2 pc. / 50 pc.	20x15Cu

## Type: 25P



Radiator connection nickel-plated 1100 mm copper pipe Ø15  
 Radiatoraansluitbocht vernikkeld met 1100 mm koperbuis Ø15  
 Alimentation radiateur nickelé 1100 mm tube de cuivre Ø15  
 Heizkörperanschluss vernickelt 1100 mm Kupferrohr Ø15

Article number	Tasche	Type
25P-1604	2 pc.	16x15Cu
25P-2004	2 pc.	20x15Cu

## Type: 26P



Union with flat seat  
 3-delige koppeling vlak dichtend  
 Raccord union à joint plat  
 Verschraubung flachdichtend

Article number	Bag / Box	Type
26P-1604	10 pc. / 100 pc.	16x1/2"
26P-1605	10 pc. / 80 pc.	16x3/4"
26P-2004	10 pc. / 80 pc.	20x1/2"
26P-2005	10 pc. / 70 pc.	20x3/4"
26P-2605	5 pc. / 50 pc.	26x3/4"
26P-2606	5 pc. / 40 pc.	26x1"
26P-3206	5 pc. / 40 pc.	32x1"





**Type: 26P-Z**



**Press fitting swivel adapter**  
**Aansluiting met wartel, vlakke dichting**  
**Raccord à visser, joint plat**  
**Pressfitting mit IG flachdichtend ohne Nippel**

Article number	Bag / Box	Type
26P-14Z04	10 pc. / 150 pc.	14x1/2"
26P-16Z03	10 pc. / 150 pc.	16x3/8"
26P-16Z04	10 pc. / 150 pc.	16x1/2"
26P-16Z05	10 pc. / 80 pc.	16x3/4"
26P-18Z05	10 pc. / 80 pc.	18x3/4"
26P-20Z04	10 pc. / 150 pc.	20x1/2"
26P-20Z05	10 pc. / 70 pc.	20x3/4"
26P-26Z05	5 pc. / 50 pc.	26x3/4"
26P-26Z06	5 pc. / 40 pc.	26x1"
26P-32Z06	5 pc. / 40 pc.	32x1"
26P-32Z07	5 pc. / 40 pc.	32x1 1/4"

**Type: N**



**Nipple for 26P-Z**  
**Nippel voor 26P-Z**  
**Nipple pour 26P-Z**  
**Nippel für 26P-Z**

Article number	Bag / Box	Type
N04	10 pc. / 250 pc.	1/2"x3/4"
N05	10 pc. / 200 pc.	3/4"x3/4"

**Type: 27P**



**45° bend**  
**Bocht 45°**  
**Coude 45°**  
**Winkel 45°**

Article number	Bag / Box	Type
27P-2626	5 pc. / 50 pc.	26x26
27P-3232	5 pc. / 30 pc.	32x32

**Type: 28P**



**Double backplate elbow female, build-up**  
**Dubbele muurplaat binnendraad, opbouw**  
**Culasse double pour sanitaire femelle**  
**Sanitär Wandscheibe doppelt IG, Oberbau**

Article number	Bag / Box	Type
28P-14041604-1	1 pc. / 20 pc.	14x1/2"x16x1/2" (153 mm)
28P-16041604-1	1 pc. / 20 pc.	16x1/2"x16x1/2" (153 mm)

## Type: 28PV



Double backplate elbow female, build-in  
Dubbele muurplaat binnendraad, inbouw  
Culasse double surélevé  
Wandwinkel doppelt erhöht

Article number	Bag / Box	Type
28PV-16031603-1	1 pc. / 15 pc.	16x3/8"x16x3/8" (120 mm)
28PV-16041604-1	1 pc. / 15 pc.	16x1/2"x16x1/2" (153 mm)

## Type: 28PF



Double backplate elbow female for plaster  
Dubbel muurplaat binnendraad voor gips  
Culasse double femelle pour plâtre  
Wandscheibe doppelt IG für Gips

Article number	Bag / Box	Type
28PF-16041604	1 pc. / 1 pc.	16x1/2"x16x1/2"
28PF-20042004	1 pc. / 1 pc.	20x1/2"x20x1/2"

## Type: 29P-CS (CW724)



Press-fit adapter with copper pipe  
Persfitting verlengd met koperbuis  
Manchon à sertir avec tube en cuivre  
Pressfitting mit Kupferrohr

Article number	Bag / Box	Type
29P-1612-CS	10 pc. / 120 pc.	16x12 (50mm copper)
29P-1615-CS	10 pc. / 120 pc.	16x15 (50mm copper)
29P-2018-CS	10 pc. / 70 pc.	20x18 (50mm copper)
29P-2022-CS	10 pc. / 70 pc.	20x22 (50mm copper)
29P-2622-CS	10 pc. / 70 pc.	26x22 (50mm copper)

## Type: 30P



Press-fit adapter to copper compression  
Overgangsstuk Henco pers x koperbuis knelkoppeling  
Manchon à sertir x tube en cuivre manchon à visser  
Pressfitting x Klemmverbinder für Kupferrohr

Article number	Bag / Box	Type
30P-1614S	10 pc. / 120 pc.	16x14 Cu
30P-1615S-2	2 pc. / 100 pc.	16x15 Cu
30P-2022S	10 pc. / 100 pc.	20x22 Cu
30P-2622S	10 pc. / 80 pc.	26x22 Cu



## Type: 31P



Double crossover tee, nickel plated  
Kruisingsvrij T-stuk, vernikkeld  
Double T croisé, étamé  
Kreuzungs-T-Stück, vernickelt

Article number	Bag / Box	Type
31P-161616	1 pc. / 20 pc.	16x16x16
31P-161620	1 pc. / 20 pc.	16x16x20
31P-201616	1 pc. / 20 pc.	20x16x16
31P-201620	1 pc. / 20 pc.	20x16x20
31P-202020	1 pc. / 20 pc.	20x20x20

## Type: ISO-BOX



Insulation box for double crossover tee  
Isolatiebox voor kruisingsvrij T-Stuk  
Boîte d'isolation pour T croisé  
Isolierboxen für Kreuzungs-T-Stück

Article number	Box	Type
ISO-BOX	1 pc.	INSULATION BOX

## Type: 33P



Nickel plated press-fit adapter to eurocone, 90°  
Aansluiting met wartel en euroconus-koppeling vernikkeld, 90°  
Raccord à visser eurocone nickelé, 90°  
Anschlussverschraubung mit Eurokonus vernickelt, 90°

Article number	Bag / Box	Type
33P-1605	10 pc. / 60 pc.	16x3/4"

## Type: 34P



Henco press swivel adapter with flat sealing, 90°  
Aansluiting met wartel vlakdichtend, 90°  
Raccord à visser joint plat, 90°  
Anschlussverschraubung mit AG flachdichtend, 90°

Article number	Bag / Box	Type
34P-1604	10 pc. / 120 pc.	16x1/2"
34P-1605	10 pc. / 120 pc.	16x3/4"
34P-3206	5 pc. / 40 pc.	32x1"

TILL EXHAUSTION OF STOCK

## Type: 34P-CS (CW724)



Henco press swivel adapter with flat sealing, 90°

Aansluiting met wartel vlakdichtend, 90°

Raccord à visser joint plat, 90°

Anschlussverschraubung mit AG flachdichtend, 90°

Article number	Bag / Box	Type
34P-1605-CS	10 pc. / 120 pc.	16x3/4"
34P-2004-CS	10 pc. / 80 pc.	20x2"
34P-2005-CS	10 pc. / 80 pc.	20x3/4"
34P-2605-CS	10 pc. / 70 pc.	26x3/4"

## Type: 35P



Press-fit adapter to copper press (M-profile)

Overgangsstuk Henco pers naar koper pers (M-profiel)

Manchon à sertir vers cuivre à sertir (profil M)

Pressfitting Henco zu Pressfitting für Kupferrohr (M-profile)

Article number	Bag / Box	Type
35P-1615P	10 pc. / 150 pc.	16x15Cu M-profile
35P-2018P	10 pc. / 120 pc.	20x18Cu M-profile
35P-2022P	10 pc. / 80 pc.	20x22Cu M-profile
35P-3228P	5 pc. / 50 pc.	32x28Cu M-profile

TILL EXHAUSTION OF STOCK

## Type: 36P (CW724)



Press-fit adapter to copper press or thin steel (V, M & SA-profile)

Overgangsstuk Henco pers naar koper pers of dunwandig staal (V, M & SA-profiel)

Manchon à sertir vers cuivre à sertir (profil M, V & SA)

Pressfitting Henco zu Pressfitting für Kupferrohr oder dünnwandig Stahl (Presskontur M, V & SA)

Article number	Bag / Box	Type
36P-1612P	10 pc. / 160 pc.	16x12Cu
36P-1614P	10 pc. / 150 pc.	16x14Cu
36P-1615P	10 pc. / 150 pc.	16x15Cu
36P-1616P	10 pc. / 150 pc.	16x16Cu
36P-2015P	10 pc. / 120 pc.	20x15Cu
36P-2018P	10 pc. / 120 pc.	20x18Cu
36P-2022P	10 pc. / 80 pc.	20x22Cu
36P-2622P	10 pc. / 70 pc.	26x22Cu
36P-2628P	5 pc. / 50 pc.	26x28Cu
36P-3228P	5 pc. / 50 pc.	32x28Cu

## Type: 37P

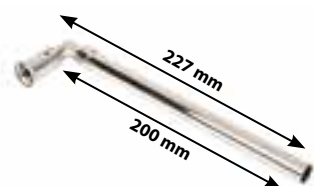

Press-fit adapter to copper pipe, elbow

Persfitting verlengd met koperbuis, knie

Coude à sertir avec tube en cuivre soudé

Pressfitting mit geschweisstem Kupferrohr, Winkel

Article number	Bag / Box	Type
37P-1412L	10 pc. / 60 pc.	14x12 (227/200mm)
37P-1612L	10 pc. / 60 pc.	16x12 (227/200mm)
37P-1615L	10 pc. / 60 pc.	16x15 (227/200mm)



**Type: 39P**



Double bend for radiator nickel-plated 300 mm copper pipe Ø15, connected end  
 Dubbele radiatorbocht koperbuis Ø15, 300 mm, vernikkeld, doorverbonden einde  
 Double courbe radiateur nickelé 300 mm tube en cuivre, bout rattaché  
 Doppelter Heizkörperwinkel vernickelt 300 mm Kupferrohr Ø15, durchgestelltes Ende

Article number	Bag / Box	Typ
39P-160450	1 pc. / 8 pc.	16x1/2" (AS = 50 mm)

*Interaxis 50 mm*

**Type: 40P**



Press-fit elbow to copper compression  
 Knie Henco pers x koperbuis knelkoppeling  
 Coude à sertir x tube en cuivre manchon à visser, 90°  
 Winkel Henco Press x Klemmverbinder für Kupferrohr

Article number	Bag / Box	Type
40P-1615S	10 pc. / 60 pc.	16x15 Cu
40P-2022S	10 pc. / 60 pc.	20x22 Cu
40P-2622S	10 pc. / 60 pc.	26x22 Cu

**Type: 41P**



Brass press coupling with valve F-connection  
 Messing perskoppeling met F-aansluiting  
 Connecteur F à sertir  
 Pressfittung mit F-Connection

Article number	Bag / Box	Type
41P-16	10 pc. / 40 pc.	16
41P-20	10 pc. / 40 pc.	20
41P-26	10 pc. / 40 pc.	26

**BA-F41**  
(p. 109)

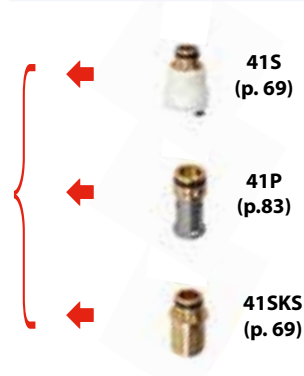

**Type: 42P**



Straight coupling PEX  
 Doorverbinder recht PEX  
 Manchon PEX  
 Kupplung PEX

Article number	Bag / Box	Type
42P-161615	10 pc. / 200 pc.	16x16x15
42P-202019	10 pc. / 140 pc.	20x20x19

## Type: 43P



T-piece Henco press 16 x compression 15 x Henco press 16  
 T-stuk Henco pers 16 x koper knel 15 x Henco pers 16  
 Pièce en T Henco sertir 16 x manchon à visser 15 x Henco sertir 16  
 T-Stuck Henco Press 16 x Klemmverbinder 15 x Henco Press 16

Article number	Bag / Box	Type
43P-161516	2 pc. / 50 pc.	16x15x16

## Type: 52P



Easy mounting/repair fitting  
 Eenvoudige montage/reparatie fitting  
 Raccord montage/réparation facile  
 Einfache Montage/Reparatur Fitting

Article number	Bag / Box	Type
52P16	1 pc. / 40 pc.	16x16
52P20	1 pc. / 30 pc.	20x20
52P26	1 pc. / 30 pc.	26x26
52P32	1 pc. / 30 pc.	32x32

for Ø40, 50 and 63: chapter 2, article 53PK

## Type: WALL BOX

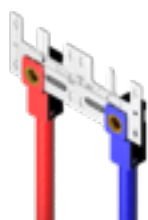

Wall box 2 pair red/blue, 1/2"Fx16mm  
 Wall box 2 paar rood/blauw, 1/2"Fx16mm  
 Wall box 2 paires rouge/bleu, 1/2"Fx16mm  
 Wall box 2 Paare red/blau, 1/2"Fx16mm

Article number	Bag / Box	Type
WBP-1604	1 pc. / 40 pc.	16x1/2"
WBP-2004	1 pc. / 40 pc.	20x1/2"



Instruction video

## Type: 17VBS



Straight adapter VBS manifold  
 Recht aansluitstuk VBS verdeler  
 Raccord droit VBS collecteur  
 Gerades Verbindungsstück AG VBS Verteiler

Article number	pc / Box	Type
■ 17VBS-2005	10/150	20mmx3/4"
■ 17VBS-2605	5/80	26mmx3/4"
■ 17VBS-2606	5/80	26mmx1"

Article 17VBS to be used in combination with the VBS manifold, see page 105



Gas: only allowed in countries where has been a HENCO GAS testing + certificate is available! (See [www.henco.be](http://www.henco.be))  
 Gas: enkel toegelaten in landen waar er een HENCO GAS keur is + certificaat voorhanden is! (Zie [www.henco.be](http://www.henco.be))  
 Gaz: seulement permis dans des pays où le contrôle a eu lieu + certificat est disponible! (Consultez [www.henco.be](http://www.henco.be))  
 Gas: nur zugelassen in Länder wo HENCO GAS Prüfung geschehen ist + Zertifikat vorhanden ist! (Siehe [www.henco.be](http://www.henco.be))

Henco brass press fittings for gas in combination with standard pipes gas, see page 19



## Type: 1PG



Elbow 90°  
 Knie 90°  
 Coude 90°  
 Winkel 90°

Article number	Bag / Box	Type
1PG-1616	10 pc. / 150 pc.	16x16
1PG-2020	10 pc. / 80 pc.	20x20
1PG-2626	5 pc. / 50 pc.	26x26
1PG-3232	5 pc. / 50 pc.	32x32

## Type: 2PG



Backplate elbow female  
 Muurplaat binnendraad  
 Culasse femelle  
 Wandscheibe IG

Article number	Bag / Box	Type
2PG-1604	10 pc. / 50 pc.	16x1/2" (52 mm)
2PG-2004	10 pc. / 50 pc.	20x1/2" (52 mm)
2PG-2005	10 pc. / 50 pc.	20x3/4" (52mm)
2PG-2605	5 pc. / 50 pc.	26x3/4" (52 mm)

## Type: 2PG-K



Backplate elbow female, short model  
 Muurplaat binnendraad, laag  
 Culasse femelle, modèle court  
 Wandscheibe IG, kurzes Modell

Article number	Bag / Box	Type
2PG-1604K	10 pc. / 50 pc.	16x1/2" (35 mm)

## Type: 3PG



Double backplate elbow female  
 Muurplaat binnendraad dubbel  
 Culasse double  
 Wandscheibedoppelt IG

Article number	Bag / Box	Type
3PG-160416	10 pc. / 50 pc.	16x1/2"x16 (52 mm)
3PG-200420	10 pc. / 40 pc.	20x1/2"x20 (52 mm)

## Type: 5PG



Elbow 90° male adapter  
Knie 90° buitendraad  
Coude 90° mâle  
Winkel 90° AG

Article number	Bag / Box	Type
5PG-1604	10 pc. / 150 pc.	16x1/2"
5PG-2004	10 pc. / 100 pc.	20x1/2"
5PG-2005	10 pc. / 80 pc.	20x3/4"
5PG-2605	10 pc. / 60 pc.	26x3/4"

## Type: 6PG



Elbow 90° female adapter  
Knie 90° binnendraad  
Coude 90° femelle  
Winkel 90° IG

Article number	Bag / Box	Type
6PG-1604	10 pc. / 120 pc.	16x1/2"
6PG-2004	10 pc. / 120 pc.	20x1/2"
6PG-2005	10 pc. / 50 pc.	20x3/4"
6PG-2605	5 pc. / 50 pc.	26x3/4"

## Type: 9PG



T-piece  
T-stuk  
Pièce en T  
T-Stück

Article number	Bag / Box	Type
9PG-161616	10 pc. / 60 pc.	16x16x16
9PG-202020	10 pc. / 50 pc.	20x20x20
9PG-323232 *	1 pc. / 20 pc.	32x32x32

*\*TILL EXHAUSTION OF STOCK*

## Type: 10PG



T-reduced centre  
T-verlopend  
Pièce en T-réduit  
T-reduziert

Article number	Bag / Box	Type
10PG-262026	5 pc. / 30 pc.	26x20x26

## Type: 11PG



T-branch and line reduced  
T-2X verlopend  
Pièce en T 2X réduit  
T-2X reduziert

Article number	Bag / Box	Type
11PG-201616	10 pc. / 50 pc.	20x16x16





**Type: 13PG**



T-female centre  
T-binnendraad  
Pièce en T femelle  
T-IG

Article number	Bag / Box	Type
13PG-200420	10 pc. / 50 pc.	20x1/2"x20
13PG-200520	10 pc. / 30 pc.	20x3/4"x20
13PG-260426	5 pc. / 30 pc.	26x1/2"x26
13PG-260526	5 pc. / 30 pc.	26x3/4"x26
13PG-320632 *	5 pc. / 20 pc.	32x1"x32

*\*TILL EXHAUSTION OF STOCK*

**Type: 15PG**



Straight coupling  
Doorverbinder recht / perssok  
Manchon  
Kupplung

Article number	Bag / Box	Type
15PG-1616	10 pc. / 200 pc.	16x16
15PG-2020	10 pc. / 140 pc.	20x20
15PG-2626	5 pc. / 80 pc.	26x26
15PG-3232	5 pc. / 50 pc.	32x32

**Type: 16PG**



Reducing coupling  
Verloopstuk  
Réduction  
Kupplung-reduziert

Article number	Bag / Box	Type
16PG-2016	10 pc. / 150 pc.	20x16
16PG-2620	5 pc. / 80 pc.	26x20
16PG-3226	5 pc. / 40 pc.	32x26

**Type: 17PG**



Straight male adapter  
Recht aansluitstuk buitendraad / Puntstuk  
Raccord droit mâle  
Übergangsfitting AG

Article number	Bag / Box	Type
17PG-1604	10 pc. / 150 pc.	16x1/2"
17PG-2004	10 pc. / 150 pc.	20x1/2"
17PG-2005	10 pc. / 150 pc.	20x3/4"
17PG-2605	5 pc. / 80 pc.	26x3/4"
17PG-2606	5 pc. / 80 pc.	26x1"
17PG-3206	5 pc. / 50 pc.	32x1"

## Type: 18PG



**Straight female adapter**  
**Recht aansluitstuk binnendraad / Schroefbus**  
**Raccord droit femelle**  
**Übergangsfitting IG**

Article number	Bag / Box	Type
18PG-1604	10 pc. / 150 pc.	16x1/2"
18PG-2004	10 pc. / 100 pc.	20x1/2"
18PG-2005	10 pc. / 100 pc.	20x3/4"
18PG-2605	5 pc. / 80 pc.	26x3/4"
18PG-2606	5 pc. / 50 pc.	26x1"
18PG-3206	5 pc. / 50 pc.	32x1"

## Type: 30PG



**Press-fit adapter to copper compression**  
**Overgangsstuk Henco pers x koperbuis knelkoppeling**  
**Manchon henco à sertir x tube de cuivre manchon à visser**  
**Pressfitting x Klemmverbinder für Kupferrohr**

Article number	Bag / Box	Type
30PG-1615S-2	10 pc. / 120 pc.	16x15 Cu
30PG-2022S	10 pc. / 100 pc.	20x22 Cu
30PG-2622S	10 pc. / 80 pc.	26x22 Cu

## Type: 36PG



**Press-fit adapter to copper press (V, M & SA-profile)**  
**Overgangsstuk Henco pers naar koper pers (V, M & SA-profiel)**  
**Manchon à sertir vers cuivre à sertir (profil M, V & SA)**  
**Pressfitting Henco zu Pressfitting für Kupferrohr (Presskontur M, V & SA)**

Article number	Bag / Box	Type
36PG-1615P	10 pc. / 150 pc.	16x15Cu
36PG-2015P	10 pc. / 120 pc.	20x15Cu
36PG-2022P	10 pc. / 80 pc.	20x22Cu
36PG-2615P	10 pc. / 80 pc.	26x15Cu
36PG-2622P	10 pc. / 70 pc.	26x22Cu





- 1
- 2
- 3
- 4
- 5
- 6
- 7
- 8
- 9
- 10
- 11

### Type: 1



**Straight male adapter**  
**Recht aansluitstuk buitendraad / Puntstuk**  
**Raccord droit mâle**  
**Kupplung AG**

Article number	Bag / Box	Type
1-1403C *	10 pc. / 250 pc.	14x3/8" + o-ring
1-1404	10 pc. / 250 pc.	14x1/2" + o-ring
1-1604	10 pc. / 180 pc.	16x1/2" + o-ring
1-1604Z	10 pc. / 250 pc.	16x1/2"
1-1605	10 pc. / 150 pc.	16x3/4"
1-1804	10 pc. / 150 pc.	18x1/2" + o-ring
1-1805 **	10 pc. / 150 pc.	18x3/4"
1-2004	10 pc. / 150 pc.	20x1/2" + o-ring
1-2004Z	10 pc. / 150 pc.	20x1/2"
1-2005	10 pc. / 150 pc.	20x3/4"
1-2605	5 pc. / 80 pc.	26x3/4"
1-2606	5 pc. / 80 pc.	26x1"
1-3206	5 pc. / 80 pc.	32x1"

\* FOR FUEL OIL

\*\* TILL EXHAUSTION OF STOCK

### Type: 2



**Straight coupling**  
**Doorverbinder recht**  
**Manchon**  
**Kupplung doppelt**

Article number	Bag / Box	Type
2-1616	10 pc. / 200 pc.	16x16
2-1818	10 pc. / 120 pc.	18x18
2-2020	10 pc. / 120 pc.	20x20
2-2626 *	5 pc. / 60 pc.	26x26
2-3232 *	5 pc. / 40 pc.	32x32

\* TILL EXHAUSTION OF STOCK

### Type: 3



**Straight female adapter**  
**Recht aansluitstuk binnendraad / Schroefbus**  
**Raccord droit femelle**  
**Kupplung IG**

Article number	Bag / Box	Type
3-1403C * **	10 pc. / 200 pc.	14x3/8"
3-1404 **	10 pc. / 200 pc.	14x1/2"
3-1604	10 pc. / 170 pc.	16x1/2"
3-1804	10 pc. / 120 pc.	18x1/2"
3-2004	10 pc. / 120 pc.	20x1/2"
3-2005	10 pc. / 120 pc.	20x3/4"
3-2605	5 pc. / 80 pc.	26x3/4"
3-2606	5 pc. / 80 pc.	26x1"
3-3206 **	5 pc. / 80 pc.	32x1"

\* FOR FUEL OIL

\*\* TILL EXHAUSTION OF STOCK



### Type: 4



Elbow 90°  
 Knie 90°  
 Coude 90°  
 Winkel 90°

Article number	Bag / Box	Type
4-1414 *	10 pc. / 150 pc.	14x14
4-1616	10 pc. / 110 pc.	16x16
4-2020	10 pc. / 60 pc.	20x20
4-2626	10 pc. / 40 pc.	26x26
4-3232 *	5 pc. / 32 pc.	32x32

\* TILL EXHAUSTION OF STOCK

### Type: 5



Elbow 90° male adapter  
 Knie 90° buitendraad  
 Coude 90° mâle  
 Winkel 90° AG

Article number	Bag / Box	Type
5-1604	10 pc. / 150 pc.	16x1/2"
5-1804 *	10 pc. / 100 pc.	18x1/2"
5-2005	10 pc. / 100 pc.	20x3/4"
5-2606	5 pc. / 40 pc.	26x1"
5-3206 *	5 pc. / 40 pc.	32x1"

\* TILL EXHAUSTION OF STOCK

### Type: 6



Elbow 90° female adapter  
 Knie 90° binnendraad  
 Coude 90° femelle  
 Winkel 90° IG

Article number	Bag / Box	Type
6-1404 *	10 pc. / 150 pc.	14x1/2"
6-1604	10 pc. / 150 pc.	16x1/2"
6-1804 *	10 pc. / 90 pc.	18x1/2"
6-2004 *	10 pc. / 80 pc.	20x1/2"
6-2005	10 pc. / 80 pc.	20x3/4"
6-2605 *	5 pc. / 50 pc.	26x3/4"
6-2606 *	5 pc. / 30 pc.	26x1"
6-3206 *	5 pc. / 40 pc.	32x1"

\* TILL EXHAUSTION OF STOCK

- 1
- 2
- 3
- 4
- 5
- 6
- 7
- 8
- 9
- 10
- 11



## Type: 7



Backplate elbow with branch connection

Sanitair muurplaat binnendraad

Culasse pour sanitaire femelle

Sanitär Wandscheibe

Article number	Bag / Box	Type
7-1404 *	10 pc. / 80 pc.	14x1/2"
7-1604	10 pc. / 80 pc.	16x1/2"
7-2004	10 pc. / 60 pc.	20x1/2"

\* TILL EXHAUSTION OF STOCK

## Type: 7D



Double backplate elbow with branch connection

Sanitair muurplaat binnendraad dubbel

Culasse pour sanitaire femelle double

Sanitär Wandscheibe doppelt

Article number	Bag / Box	Type
7-160416	10 pc. / 50 pc.	16x1/2"x16

TILL EXHAUSTION OF STOCK

## Type: 8



T-piece

T-stuk

Piece en T

T-Stück

Article number	Bag / Box	Type
8-161616	10 pc. / 70 pc.	16x16x16
8-181818 *	10 pc. / 50 pc.	18x18x18
8-202020	10 pc. / 50 pc.	20x20x20

\* TILL EXHAUSTION OF STOCK



### Type: 9



T-female branch  
T-binnendraad  
Pièce en T femelle  
T-IG

Article number	Bag / Box	Type
9-140414 *	10 pc. / 80 pc.	14x1/2"x14
9-160416	10 pc. / 80 pc.	16x1/2"x16
9-200420 *	10 pc. / 40 pc.	20x1/2"x20
9-200520	10 pc. / 40 pc.	20x3/4"x20
9-260526 *	5 pc. / 30 pc.	26x3/4"x26

\* TILL EXHAUSTION OF STOCK

### Type: 10



Nut, insert and jointing ring  
Moer, Insert en klemring  
Ecrou, insert et bicône  
Mutter, Stutzhülse und Klemmring

Article number	Bag / Box	Type
10-1604SN	10 pc. / 300 pc.	16x1/2"

TILL EXHAUSTION OF STOCK

### Type: 11



T-male branch  
T-buitendraad  
Pièce en T mâle  
T-AG

Article number	Bag / Box	Type
11-200420 *	10 pc. / 70 pc.	20x1/2"x20
11-260526 *	5 pc. / 30 pc.	26x3/4"x26
11-260626 *	5 pc. / 30 pc.	26x1"x26

\* TILL EXHAUSTION OF STOCK

### Type: 13-2



Nut, insert and jointing ring to copper compression  
Adapter Henco buis naar messing knelverbinding  
Raccord à visser cuivre vers multicouche  
Verbindungsstück Kupfer Schraubfitting auf Henco

Article number	Bag / Box	Type
13-1415-2 *	2 pc. / 200 pc.	14x15 Cu
13-1615A-2 *	2 pc. / 200 pc.	16x15 Cu
13-1615HA-2	2 pc. / 200 pc.	16x15 Cu
13-2022HA-2	2 pc. / 120 pc.	20x22 Cu
13-2628H-2	2 pc. / 80 pc.	26x28 Cu

\* Nickel plated nut



### Type: 13-VH



Adapter for Henco compression 26mm to copper compression 22mm  
 Adapter Henco buis 26mm naar messing knelverbinding 22mm  
 Adapteur raccord à visser cuivre 22mm vers multicouche 26mm  
 Verbindungsstück für Henco Schraubfitting 26mm auf Kupfer Schraubfitting 22mm

Article number	Bag / Box	Type
13-V2622H-2	2 pc. / 70 pc.	26x22 Cu

### Type: 24



Compression coupling Henco x copper tube  
 Overgangsstuk Henco knel x koperbuis knelverbinding  
 Raccord droit Henco x tube de cuivre manchon à visser  
 Gerade Fitting Henco x Klemmverbinder für Kupferrohr

Article number	Bag / Box	Type
24-1615-S	10 pc. / 200 pc.	16x15 Cu
24-2022	10 pc. / 100 pc.	20x22 Cu
24-2622	5 pc. / 50 pc.	26x22 Cu
24-2628	5 pc. / 50 pc.	26x28 Cu

### Type: 28



T-reduced centre  
 T-verlopend  
 Pièce en T réduit  
 T-reduziert

Article number	Bag / Box	Type
28-201620	5 pc. / 50 pc.	20x16x20
28-202016 *	5 pc. / 50 pc.	20x20x16
28-262026 *	5 pc. / 30 pc.	26x20x26

\*TILL EXHAUSTION OF STOCK





## Type: EK



Nickel plated eurocone (3/4" F)  
 Euroconus schroefkoppeling (3/4" F)  
 Raccord à visser eurocone (3/4" F)  
 Schraubfitting Eurokonus (3/4" F)

Article number	Bag / Box	Type
EK12-2	2 pc. / 100 pc.	Ø12
EK14-2	2 pc. / 100 pc.	Ø14
EK16-2	2 pc. / 100 pc.	Ø16
EK17-2	2 pc. / 100 pc.	Ø17
EK18-2	2 pc. / 100 pc.	Ø18
EK20-2	2 pc. / 100 pc.	Ø20

## Type: EKH



Brass eurocone (3/4" F)  
 Euroconus-schroefkoppeling (3/4" F) niet vernikkeld  
 Raccord à visser eurocone (3/4" F) laiton non nickelé  
 Schraubfitting Eurokonus (3/4" F) Messing nicht vernickelt

Article number	Bag / Box	Type
EKH16-2	2 pc. / 100 pc.	Ø16

## Type: EK15



Eurocone (3/4" F) for copper tube 15mm  
 Euroconus-schroefkoppeling (3/4" F) voor koperbuis 15mm  
 Raccord à visser eurocone (3/4" F) pour tube de cuivre 15mm  
 Schraubfitting Eurokonus (3/4" F) für Kupferrohr 15mm

Article number	Bag / Box	Type
EK15	25 pc. / 400 pc.	Ø15

## Type: SPLIT-S



Split ring for compression fittings (not for EK)  
 Klemring voor schroef fittingen (niet voor EK)  
 Anneau de serrage pour raccords à visser (pas pour EK)  
 Klemring für Schraubfitting (nicht für EK)

Article number	Bag	Type
SPLIT-S16	10 pc.	Ø16
SPLIT-S20	10 pc.	Ø20



- 1
- 2
- 3
- 4
- 5
- 6
- 7
- 8
- 9
- 10
- 11

**Type: AB**



Elbow 90° eurocone elbow (3/4" M)  
 Knie 90° voor euroconus-aansluiting (3/4" M)  
 Coude 90° pour raccordement eurocone (3/4" M)  
 Winkel 90° für Eurokonusanschluß (3/4" M)

Article number	Bag / Box	Type
AB1420	10 pc. / 100 pc.	3/4"x3/4" for EK

**Type: ABE**



Elbow 90° eurocone (3/4" M) x 1/2" male adapter  
 Knie 90° buitendraad 1/2 x euroconus-aansluiting (3/4" M)  
 Coude 90° mâle 1/2" x raccordement eurocone (3/4" M)  
 Winkel 90° AG 1/2 x Eurokonusanschluss (3/4" M)

Article number	Bag / Box	Type
ABEK04	10 pc. / 150 pc.	1/2"x3/4"

**Type: AT**



Eurocone equal T  
 T voor euroconus-aansluiting (3/4" M)  
 Pièce en T pour raccordement eurocone (3/4" M)  
 T für Eurokonusanschluß (3/4" M)

Article number	Bag / Box	Type
AT1420	10 pc. / 100 pc.	3/4"x3/4"x3/4"

**Type: AD**



Eurocone straight coupling (3/4" M)  
 Euroconus nippel (3/4" M)  
 Mamelon 2x raccordement eurocone (3/4" M)  
 Nippel für 2x Eurokonusanschluss

Article number	Bag / Box	Type
AD-EKEK	10 pc. / 250 pc.	3/4"x3/4" for



### Type: AN



Straight eurocone connection (3/4" M) to 1/2" male adapter  
 Recht overgangsstuk 1/2" M met O-ring en -aansluiting (3/4" M)  
 Manchon droit mâle 1/2" avec o-ring et eurocone  
 Nippel AG 1/2" mit O-ring und Eurokonusanschluss (3/4" M)

Article number	Bag / Box	Type
AN1420	10 pc. / 250 pc.	1/2"x3/4" for

### Type: 3EK



Double backplate elbow female, 2x eurocone connection  
 Doorstroom muurplaat binnendraad, 2x euroconus-aansluiting  
 Culasse double, 2x raccordement eurocone  
 Wandscheibe doppelt IG, 2x Eurokonusanschluss

Article number	Bag / Box	Type
3EK-050405	5 pc. / 40 pc.	3/4"x1/2"x3/4" (50 mm)

### Type: WALL BOX

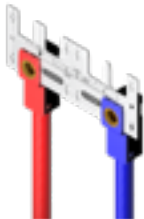

Wall box 2 pair red/blue, 1/2" FX16mm  
 Wall box 2 paar rood/blauw, 1/2" FX16mm  
 Wall box 2 paires rouge/bleu, 1/2" FX16mm  
 Wall box 2 Paare red/blau, 1/2" FX16mm

Article number	Bag / Box	Type.
WBS-1604	1 pc. / 40 pc.	16x1/2"



Instruction video

- 1
- 2
- 3
- 4
- 5
- 6
- 7
- 8
- 9
- 10
- 11





**Type: V-06**

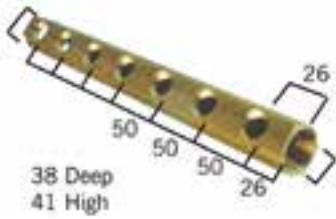

**Manifold 1", 1/2" female thread, 3/8" air vent hole**  
**Verdeler 1", 1/2" aansluitingen, 3/8" ontluichtingsopening**  
**Collecteur 1", conn. 1/2" femelle, conn. 3/8" pour purgeur**  
**Verteiler 1", 1/2" IG, 3/8" Loch für Entlüftung**

Article number	pc / Box	Type
V-060402	1 pc. / 64 pc.	1" 2x1/2" x 3/8"
V-060403	1 pc. / 48 pc.	1" 3x1/2" x 3/8"
V-060404	1 pc. / 30 pc.	1" 4x1/2" x 3/8"
V-060405	1 pc. / 28 pc.	1" 5x1/2" x 3/8"
V-060406	1 pc. / 20 pc.	1" 6x1/2" x 3/8"
V-060407	1 pc. / 25 pc.	1" 7x1/2" x 3/8"
V-060408	1 pc. / 20 pc.	1" 8x1/2" x 3/8"
V-060409*	1 pc. / 20 pc.	1" 9x1/2" x 3/8"

*\* TILL EXHAUSTION OF STOCK*

**Type: V-05-Z**

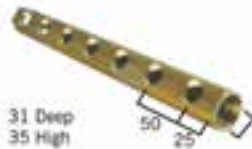

**Manifold 3/4", 1/2" female thread**  
**Verdeler 3/4", 1/2" aansluitingen**  
**Collecteur 3/4", conn. 1/2" femelle**  
**Verteiler 3/4", 1/2" IG**

Article number	pc / Box	Type
V-050403-Z	1 pc. / 48 pc.	3/4" 3x1/2"
V-050404-Z	1 pc. / 30 pc.	3/4" 4x1/2"
V-050405-Z	1 pc. / 42 pc.	3/4" 5x1/2"
V-050406-Z*	1 pc. / 20 pc.	3/4" 6x1/2"

*\* TILL EXHAUSTION OF STOCK*

**Type: V-06-Z**

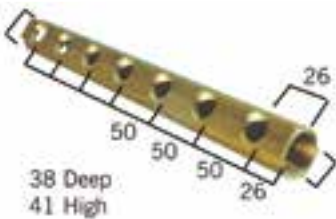

**Manifold 1", 1/2" female thread**  
**Verdeler 1", 1/2" aansluitingen**  
**Collecteur 1", conn. 1/2" femelle**  
**Verteiler 1", 1/2" IG**

Article number	pc / Box	Type
V-060402-Z	1 pc. / 64 pc.	1" 2x1/2"
V-060408-Z	1 pc. / 20 pc.	1" 8x1/2"

**Type: V-07-Z**

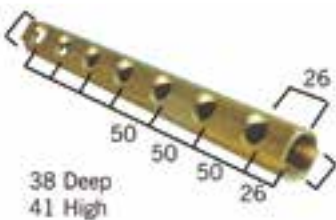

**Manifold 5/4", 1/2" female thread**  
**Verdeler 5/4", 1/2" aansluitingen**  
**Collecteur 5/4", conn. 1/2" femelle**  
**Verteiler 5/4", 1/2" IG**

Article number	pc / Box	Type
V-070405-Z	1 pc. / 14 pc.	5/4" 5x1/2"
V-070406-Z	1 pc. / 15 pc.	5/4" 6x1/2"
V-070407-Z	1 pc. / 20 pc.	5/4" 7x1/2"
V-070408-Z	1 pc. / 20 pc.	5/4" 8x1/2"
V-070410-Z	1 pc. / 10 pc.	5/4" 10x1/2"



**Type: VEK-06**



**Manifold 1" with connections and one 3/8" air vent hole**  
**Verdeler 1" met EK-aansluitingen en 3/8" ontluichtingsopening**  
**Collecteur 1" avec des raccords eurocone et un trou 3/8" pour purgeur**  
**Verteiler 1" mit -Anschlüssen und 3/8" Loch für Entlüftung**

Article number	pc / Box	Type
VEK-060502	1 pc. / 48 pc.	1" 2x3/4" x 3/8"
VEK-060503	1 pc. / 32 pc.	1" 3x3/4" x 3/8"
VEK-060504	1 pc. / 20 pc.	1" 4x3/4" x 3/8"
VEK-060505	1 pc. / 21 pc.	1" 5x3/4" x 3/8"
VEK-060506	1 pc. / 20 pc.	1" 6x3/4" x 3/8"
VEK-060507	1 pc. / 20 pc.	1" 7x3/4" x 3/8"
VEK-060508	1 pc. / 20 pc.	1" 8x3/4" x 3/8"
VEK-060509	1 pc. / 15 pc.	1" 9x3/4" x 3/8"
VEK-060510	1 pc. / 15 pc.	1" 10x3/4" x 3/8"

**Type: VEK-06-Z**

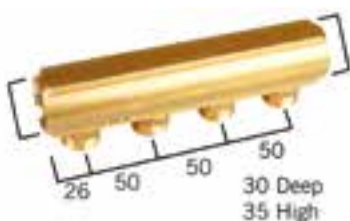

**Manifold 1" with eurocone connections**  
**Verdeler 1" met euroconus-aansluitingen**  
**Collecteur 1" avec des raccords eurocone**  
**Verteiler 1" mit Eurokonus-Anschlüssen**

Article number	pc / Box	Type
VEK-060502-Z	1 pc. / 48 pc.	1" 2x3/4"
VEK-060503-Z	1 pc. / 32 pc.	1" 3x3/4"
VEK-060504-Z	1 pc. / 20 pc.	1" 4x3/4"
VEK-060505-Z	1 pc. / 21 pc.	1" 5x3/4"
VEK-060506-Z	1 pc. / 20 pc.	1" 6x3/4"
VEK-060507-Z	1 pc. / 20 pc.	1" 7x3/4"
VEK-060508-Z	1 pc. / 20 pc.	1" 8x3/4"
VEK-060509-Z	1 pc. / 15 pc.	1" 9x3/4"
VEK-060510-Z	1 pc. / 15 pc.	1" 10x3/4"

**Type: VEK-05-Z**

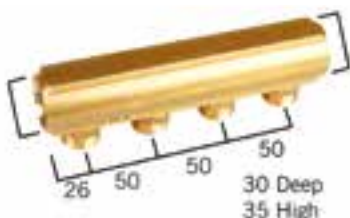

**Manifold 3/4" with eurocone connections**  
**Verdeler 3/4" met euroconus-aansluitingen**  
**Collecteur 3/4" avec des raccords eurocone**  
**Verteiler 3/4" mit Eurokonus-Anschlüssen**

Article number	pc / Box	Type
VEK-050504-Z	6 pc. / 30 pc.	3/4" 4x3/4"
VEK-050505-Z	4 pc. / 28 pc.	3/4" 5x3/4"
VEK-050507-Z	1 pc. / 25 pc.	3/4" 7x3/4"
VEK-050508-Z	1 pc. / 25 pc.	3/4" 8x3/4"
VEK-050509-Z	1 pc. / 20 pc.	3/4" 9x3/4"



### Type: VEK-06-ZV



Manifold 1" with eurocone connections  
 Verdeler 1" met euroconus-aansluitingen  
 Collecteur 1" avec des raccordements eurocone  
 Verteiler 1" mit Eurokonus-Anschlüssen

Article number	pc / Box	Type
VEK-060502-ZV	1 pc. / 8 pc.	1" 2x3/4"

TILL EXHAUSTION OF STOCK

### Type: H-0212



Insulated manifold bracket (pairs)  
 Ophangbeugel dubbel met isolatie voor alle verdelers  
 Support double avec isolation pour tous les collecteurs  
 Verteiler-Halter mit Isolierung doppelt für alle Verteiler

Article number	pc / Box	Type
H-0212	1 pc. / 150 pc.	3/4" - 1 - 5/4"

### Type: H-0212-S



Insulated manifold bracket (single)  
 Ophangbeugel enkel met isolatie voor alle verdelers  
 Support simple avec isolation pour tous les collecteurs  
 Verteiler-Halter mit Isolierung einfach für alle Verteiler

Article number	pc / Box	Type
H-0212-S	1 pc. / 500 pc.	3/4" - 1" - 5/4"

### Type: VS REDUCTIE



Manifold reducer with O-ring  
 Reductie met O-ring voor verdeler  
 Réduction avec O-ring pour collecteur  
 Reduktion für Verteiler mit O-ring

Article number	pc / Box	Type
VS-0504	10 pc. / 500 pc.	3/4"x1/2"
VS-0604	10 pc. / 250 pc.	1"x1/2"
VS-0605	10 pc. / 250 pc.	1"x3/4"

### Type: VS BLINDSTOP



Manifold plug with O-ring  
 Blindstop met O-ring voor verdeler  
 Bouchon avec O-ring pour collecteur  
 Stopfen mit O-Ring für Verteiler

Article number	pc / Box	Type
VS-05	10 pc. / 250 pc.	3/4"
VS-06	10 pc. / 200 pc.	1"
VS-07	10 pc. / 200 pc.	5/4"

- 1
- 2
- 3
- 4
- 5
- 6
- 7
- 8
- 9
- 10
- 11



### Type: VB-EK05



**Ball valve, 2 x eurocone connection**  
**Bolkraan , 2 x euroconus aansluiting**  
**Vanne d'arrêt, 2 x raccordement eurocone**  
**Kugelhahn, 2 x Eurokonus**

Article number	Box / Big Box	Type
VB-EK05	25 pc. / 200 pc.	3/4" EK x 3/4" EK

### Type: VR-EK05



**Lockshield 2x eurocone connection**  
**Regelkraan 2x euroconus aansluiting**  
**Te de reglage 2x raccordement eurocone**  
**Asperrbare Ventil 2x eurokonus**

Article number	Type
VR-EK05	3/4" EK x 3/4" EK

### Type: VB05



**Manifold 3/4" with ball valves and eurocone connection**  
**Verdeler 3/4" met bolkraan en euroconus-aansluiting**  
**Collecteur 3/4" avec vanne d'arrêt et eurocone**  
**Verteiler 3/4" mit Kugelhahnset und Eurokonus**

Article number	pc / Box	Type
VB050502-BLAUW	5 pc. / 50 pc.	3/4"x2xEK14,16,18 & 20
VB050502-ROOD	5 pc. / 50 pc.	3/4"x2xEK14,16,18 & 20
VB050503-BLAUW	5 pc. / 50 pc.	3/4"x3xEK14,16,18 & 20
VB050503-ROOD	5 pc. / 50 pc.	3/4"x3xEK14,16,18 & 20
VB050504-BLAUW	4 pc. / 40 pc.	3/4"x4xEK14,16,18 & 20
VB050504-ROOD	4 pc. / 40 pc.	3/4"x4xEK14,16,18 & 20

### Type: VB06



**Manifold 1" with ball valves and eurocone connection**  
**Verdeler 1" met bolkraan en euroconus-aansluiting**  
**Collecteur 1" avec vanne d'arrêt et eurocone**  
**Verteiler 1" mit Kugelhahnset und Eurokonus**

Article number	pc / Box	Type
VB060502-BLAUW	5 pc. / 50 pc.	1"x2xEK14,16,18 & 20
VB060502-ROOD	5 pc. / 50 pc.	1"x2xEK14,16,18 & 20
VB060503-BLAUW	5 pc. / 40 pc.	1"x3xEK14,16,18 & 20
VB060503-ROOD	5 pc. / 40 pc.	1"x3xEK14,16,18 & 20
VB060504-BLAUW	4 pc. / 40 pc.	1"x4xEK14,16,18 & 20
VB060504-ROOD	4 pc. / 40 pc.	1"x4xEK14,16,18 & 20





### Type: VBS05



Manifold 3/4" with valves and eurocone connection

Verdeler 3/4" met kraan en euroconus-aansluiting

Collecteur 3/4" avec vanne et eurocone

Verteiler 3/4" mit Kugelhahnset und Eurokonus

Article number	pc / Box	Type
■ VBS050502-BL	1 pc. / 20 pc.	3/4"x2xEK14,16,18 & 20
■ VBS050502-RO	1 pc. / 20 pc.	3/4"x2xEK14,16,18 & 20
■ VBS050503-BL	1 pc. / 15 pc.	3/4"x3xEK14,16,18 & 20
■ VBS050503-RO	1 pc. / 15 pc.	3/4"x3xEK14,16,18 & 20
■ VBS050504-BL	1 pc. / 10 pc.	3/4"x4xEK14,16,18 & 20
■ VBS050504-RO	1 pc. / 10 pc.	3/4"x4xEK14,16,18 & 20

### Type: VBS06



Manifold 1" with valves and eurocone connection

Verdeler 1" met kraan en euroconus-aansluiting

Collecteur 1" avec vanne et eurocone

Verteiler 1" mit Kugelhahnset und Eurokonus

Article number	pc / Box	Type
■ VBS060502-BL	1 pc. / 20 pc.	1"x2xEK14,16,18 & 20
■ VBS060502-RO	1 pc. / 20 pc.	1"x2xEK14,16,18 & 20
■ VBS060503-BL	1 pc. / 15 pc.	1"x3xEK14,16,18 & 20
■ VBS060503-RO	1 pc. / 15 pc.	1"x3xEK14,16,18 & 20
■ VBS060504-BL	1 pc. / 10 pc.	1"x4xEK14,16,18 & 20
■ VBS060504-RO	1 pc. / 10 pc.	1"x4xEK14,16,18 & 20

### Type: 17VBS



Straight adapter VBS manifold

Recht aansluitstuk VBS verdeler

Raccord droit VBS collecteur

Gerades Verbindungsstück AG VBS Verteiler

Article number	pc / Box	Type
■ 17VBS-2005	10/150	20mmx3/4"
■ 17VBS-2605	5/80	26mmx3/4"
■ 17VBS-2606	5/80	26mmx1"

### Type: VBS



Plug with O-ring VBS Manifold

Endcap M met O-ring VBS verdeler

Bouchon pour VBS collecteur avec O-ring

Stopf für Verteiler VBS mit O-Ring

Article number	pc / Box	Type
■ VBS-05	10/250	3/4"
■ VBS-06	10/250	1"



**Type: RAD04-100V**

Radiator connector with 3/4" eurocone connections, straight  
 Onderblok met 3/4" euroconus-aansluitingen, recht  
 Raccord radiateur, droit, eurocone  
 Heizkörperanschluss 1/2" mit 3/4" Eurokonus-Anschlüssen, unten

Article number	Box / Big Box	Type
RAD04-100V	10 pc. / 100 pc.	1/2"x3/4" EK

**Type: RAD04-100H**

Radiator connector with 3/4" eurocone connections, Elbow  
 Onderblok met 3/4" euroconus-aansluitingen, haaks  
 Raccord radiateur, équerre, eurocone  
 Heizkörperanschluss 1/2" mit 3/4" Eurokonus-Anschlüssen, hinten

Article number	Box / Big Box	Type
RAD04-100H	10 pc. / 100 pc.	1/2"x3/4" EK

TILL EXHAUSTION OF STOCK

**Type: EK15**

Eurocone (3/4"F) for copper tube 15mm  
 Euroconus-schroefkoppeling (3/4"F) voor koperbuis 15mm  
 Raccord à visser eurocone (3/4"F) pour tube en cuivre 15mm  
 Schraubfitting Eurokonus (3/4") für Kupferrohr 15mm

Article number	Box / Big Box	Type
EK15	25 pc. / 400 pc.	Ø15

**Type: RADK2-R**

Radiator valve 1/2" with 3/4" eurocone connection, straight  
 Radiatorkraan 1/2" met 3/4" euroconus-aansluiting, recht  
 Vanne radiateur droite 1/2" avec raccordement  
 Heizkörperventil 1/2" mit 3/4" Eurokonus-Anschluss, gerade

Article number	Box / Big Box	Type
RADK2-R	10 pc. / 100 pc.	1/2"x3/4" EK

TILL EXHAUSTION OF STOCK

- 1
- 2
- 3
- 4
- 5
- 6
- 7
- 8
- 9
- 10
- 11

**Type: RADTH-VL**



Thermostatic radiator valve head  
 Thermostatisch regulelement met vaste vloeistofvoeler  
 Tête thermostatique à bulbe, équipée d'un réglage de température limite  
 Thermostatkopf mit festem Flüssigkeitsfühler

Article number	Box / Big Box	Type
RADTH-VL	10 pc. / 150 pc.	THERM

TILL EXHAUSTION OF STOCK

**Type: RADV-2-R**



2-way lockshield valve 1/2", straight x 3/4" eurocone  
 Voetventiel 1/2" 2-weg recht x 3/4" euroconus  
 Raccord droit réglable, 1/2" x eurocone  
 Absperrbare Rücklaufverschraubung Durchgang x 3/4" Eurokonus

Article number	Box / Big Box	Type
RADV-2-R	10 pc. / 100 pc.	1/2"x3/4"

TILL EXHAUSTION OF STOCK

**Type: RADH4-100V**



Straight radiator H-block with valve, supplied without nipple x 3/4" eurocone  
 Radiator H-blok met afsluiter, recht, geleverd zonder nippel x 3/4" euroconus  
 Raccord robinet vertical, eurocone, livré sans nipples  
 Heizkörperanschlussgarnitur mit 3/4" Eurokonus-Anschlüssen, unten

Article number	Box	Type
RADH4-100V	50 pc.	3/4"x3/4" EK

**Type: RADH4-100H**



Elbow radiator H-block with valve, supplied without nipple x 3/4" eurocone  
 Radiator H-blok met afsluiter, haaks, geleverd zonder nippel x 3/4" euroconus  
 Raccord robinet horizontal, eurocone, livré sans nipples  
 Heizkörperanschlussgarnitur mit 3/4" Eurokonus-Anschlüssen, hinten

Article number	Box	Type
RADH4-100H	50 pc.	3/4"x3/4" EK

**Type: RADNI**

Nipple for H radiator block  
 Nippel voor H-radiatorblok  
 Vanne pour raccord radiateur (H&V)  
 Nippel für H-Anschluss

Article number	Bag / Box	Type
RADNI-0504	10 pc. / 500 pc.	1/2"x3/4"

**Type: RAD-H**

Micromatic wheelhandle for thermostatic valve  
 Micromatisch handvat voor thermostatische kraan  
 Capuchon micromatique pour vanne thermostatique  
 Handgriff für Thermostatventil

Article number	Box	Type
RAD-H	50 pc.	HANDLE

TILL EXHAUSTION OF STOCK

**Type: RAD-B**

Elbow 1/2"  
 Koppeling 1/2"  
 Coude 1/2"  
 Winkel 1/2"

Article number	Box / Big Box	Type
RAD-B	25 pc. / 275 pc.	1/2"x3/4"

TILL EXHAUSTION OF STOCK

**Type: BAP-H**

Ball valve with handle, 2 x pressfitting  
 Kogelkraan met handvat, 2 x perskoppeling  
 Vanne à bille  
 Kugelhahnset mit Handgriff, 2 x Pressfitting

Article number	Box / Big Box	Type
BAP-H1616	10 pc. / 100 pc.	16x16
BAP-H1818	10 pc. / 100 pc.	18x18
BAP-H2020	10 pc. / 100 pc.	20x20
BAP-H2626	10 pc. / 100 pc.	26x26
BAP-H3232	10 pc. / 100 pc.	32x32

- 1
- 2
- 3
- 4
- 5
- 6
- 7
- 8
- 9
- 10
- 11

**Type: BAP-SK**



Ball valve with handle, 2 x pushfitting  
 Kogelkraan met handvat, 2 x steekfitting  
 Vanne à bille  
 Kugelhahnset mit Handgriff, 2 x Pushfitting

Article number	Box / Big Box	Type
BAP-SK1616	6 pc. / 60 pc.	16x16
BAP-SK2020	6 pc. / 30 pc.	20x20
BAP-SK2626	6 pc. / 30 pc.	26x26

**Type: BAP-SV**



Stopvalve DN10  
 Stopbolkraan DN10  
 Vanne d'arrêt DN10  
 Stopvalve DN10

Article number	Box / Big Box	Type
BAP-SV1610S	10 pc. / 100 pc.	16 x 10

**Type: BAP-CH**



Built in ball valve with crhomed lever handle 2 x pressfitting  
 Inbouwbolkraan met verchromde hefboomhandvat, 2 x perskoppeling  
 Vanne à sphere avec mache levier chromé, 2x raccord à sertir  
 Einbau Kugelhahnset mit Hebelhandgriff verchromt, 2 x Pressfitting

Article number	Box / Big Box	Type
BAP-CH1616	5 pc. / 60 pc.	16x16
BAP-CH2626	5 pc. / 50 pc.	26x26

Type: BA-F



Built in ball valve Fastec DN15  
Inbouwbolkraan Fastec DN15  
Vanne à sphere Fastec DN15  
Einbau Kugelhahnset Fastec DN15

Article number	Box / Big Box	Type
BA-F41	1 pc. / 50 pc.	

BA-F41

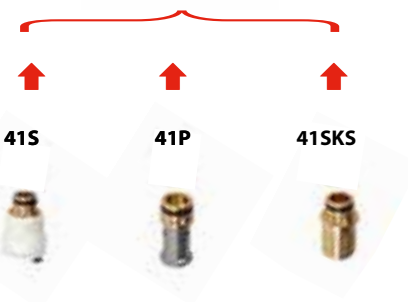

- 1
- 2
- 3
- 4
- 5
- 6
- 7
- 8
- 9
- 10
- 11



	<i>Page</i>
<b>A. SYSTEMS</b>	<b>113</b>
<b>B. MANIFOLDS</b>	<b>125</b>
<b>C. CONTROL UNITS</b>	<b>136</b>
<b>D. GEOTHERMAL</b>	<b>146</b>





## Type: UFH-ISOPRO30



System plate with 30 mm EPS insulation and 28dB acoustic improvement  
 Noppenplaat met 30 mm EPS isolatie, 28 dB geluidsverbetering  
 Plaque à plot avec isolation EPS de 30 mm, isolant acoustique 28dB  
 Systemplatte mit Dämmung Styropor 30 mm, Trittschallverbesserung 28dB

Article number	Packing	Type
UFH-ISOPRO30 *	6,72m <sup>2</sup> (6 x 1,12m <sup>2</sup> )	1400x800mm - 5kPa - 28dB

\* Pipe Ø16, centre-to-centre: multiple 50mm hor./ver.

## Type: UFH-ISOPRO11



System plate with 11 mm EPS insulation  
 Noppenplaat met 11 mm EPS isolatie  
 Plaque à plot avec isolation EPS de 11 mm  
 Systemplatte mit Dämmung Styropor 11 mm

Article number	Packing	Type
UFH-ISOPRO11 *	14,56m <sup>2</sup> (13 x 1,12m <sup>2</sup> )	1400x800mm - 75kPa

\* Pipe Ø16, centre-to-centre: multiple 50mm hor./ver.

## Type: UFH-PRO



System plate without insulation  
 Noppenplaat zonder isolatie  
 Plaque à plot sans isolation  
 Systemplatte ohne Dämmung

Article number	Packing	Type
UFH-PRO *	13,44m <sup>2</sup> (12 x 1,12m <sup>2</sup> )	1400x800mm - 5kPa

\* Pipe Ø16, centre-to-centre: multiple 50mm hor./ver.

## Type: UFH-PRO-DIA



Diagonal holder for system plate  
 Diagonaalhouder voor noppenplaat  
 Fixation diagonale en film PS  
 Diagonalfestigung aus PS

Article number	Packing	Type
UFH-PRO-DIA *	40 pc.	50 mm

\* Centre-to-centre distance diagonal: multiple 70mm

## Type: UFH-ISOPRO-AD30



Insulation plate for transition piece, 30 mm  
 Isolatieplaat voor overgangsstuk, 30 mm  
 Pièce de jonction en isolation EPS de 30 mm  
 Anschlussstück aus Styropordämmung 30 mm

Article number	Packing	Type
UFH-ISOPRO-AD30	1 pc.	1000x200x30mm

TILL EXHAUSTION OF STOCK

## Type: UFH-ISOPRO-AD11



Insulation plate for transition piece, 11 mm  
 Isolatieplaat voor overgangsstuk, 11 mm  
 Pièce de jonction en isolation EPS de 11 mm  
 Anschlussstück aus Styropordämmung 11 mm

Article number	Packing	Type
UFH-ISOPRO-AD11	1 pc.	1000x200x11mm

TILL EXHAUSTION OF STOCK

## Type: UFH-PRO-ADA



Transition piece without insulation for system plate  
 Overgangsstuk zonder isolatie voor noppenplaat  
 Pièce de jonction en film PS sans isolation  
 Anschlussstück aus PS ohne Dämmung

Article number	Packing	Type
UFH-PRO-ADA	1 pc.	1450x210mm

## Type: UFH-PRO-IND



System plate without insulation, industrial application  
 Noppenplaat zonder isolatie, voor industriële toepassing  
 Plaque à plot sans isolation, application industrielle  
 Systemplatte ohne Dämmung, Industrieanwendungen

Article number	Packing	Type
UFH-PRO-IND *	19,44m <sup>2</sup> (18 x 1,08m <sup>2</sup> )	1275x975mm

\* Pipe Ø16-20, centre-to-centre distance: multiple 75mm hor./ver.



## Type: UFH-RAS10



Galvanized steel mesh, 100 x 100 mm, 3 mm  
 Stalen draadmat verzinkt, 100 x 100 mm, 3 mm  
 Treillis en acier galvanisé, trame de 100 x 100 mm, 3 mm  
 Trägermatte aus Eisen verzinkt, Masche 100 x 100 mm, 3 mm

Article number	Packing	Type
UFH-RAS10	10 pc.	2,52m <sup>2</sup> - grid 100x100mm

## Type: UFH-RAS15

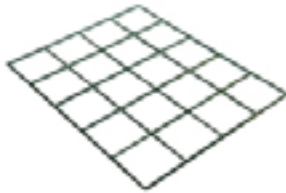

Galvanized steel mesh, 150 x 150 mm, 3 mm  
 Stalen draadmat verzinkt, 150 x 150 mm, 3 mm  
 Treillis en acier galvanisé, trame de 150 x 150 mm, 3 mm  
 Trägermatte aus Eisen verzinkt, Masche 150 x 150 mm, 3 mm

Article number	Packing	Type
UFH-RAS15	10 pc.	2,52m <sup>2</sup> - grid 150x150mm

## Type: UFH-RAS20

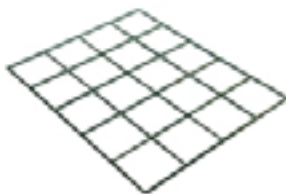

Galvanized steel mesh, 200 x 200 mm, 3 mm  
 Stalen draadmat verzinkt, 200 x 200 mm, 3 mm  
 Treillis en acier galvanisé, trame de 200 x 200 mm, 3 mm  
 Trägermatte aus Eisen verzinkt, Masche 200 x 200 mm, 3 mm

Article number	Packing	Type
UFH-RAS20	10 pc.	2,88m <sup>2</sup> - grid 200x200mm

## Type: UFH-RAS25

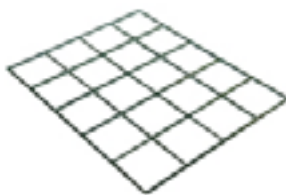

Galvanized steel mesh, 250 x 250 mm, 3 mm  
 Stalen draadmat verzinkt, 250 x 250 mm, 3 mm  
 Treillis en acier galvanisé, trame de 250 x 250 mm, 3 mm  
 Trägermatte aus Eisen verzinkt, Masche 250 x 250 mm, 3 mm

Article number	Packing	Type
UFH-RAS25	10 pc.	2,77m <sup>2</sup> - grid 250x250mm

- 1
- 2
- 3
- 4
- 5
- 6
- 7
- 8
- 9
- 10
- 11

## Type: UFH-RAS-RB3



Connection clip for steel mesh  
 Verbindingsclip voor stalen draadmatten  
 Clip de fixation pour treillis  
 Verbinder für Trägermatte

Article number	Packing	Type
UFH-RAS-RB3	30 pc.	RB

## Type: UFH-RAS-BIND15



Steel strand, plasticized, to connect pipe on steel mesh  
 Stalen vlechtdraad, geplastificeerd, om buis op draadmat te binden  
 Fil de tressage métallique, plastifié, pour fixer tube sur treillis  
 Stahldraht, plastifiziert, für Befestigung der Rohre auf Trägermatte

Article number	Packing	Type
UFH-RAS-BIND15A	250 pc.	160 mm
UFH-RAS-BIND15B	2500 pc.	160 mm

## Type: UFH-RAS-CLIP



Synthetic clip for steel mesh  
 Kunststofclip voor draadmat  
 Attache en plastique pour treillis  
 Rohrclip für Trägermatte

Article number	Packing	Type
UFH-RAS-CLIP16	200 pc.	Ø16
UFH-RAS-CLIP18	200 pc.	Ø18
UFH-RAS-CLIP20	200 pc.	Ø20

## Type: UFH-TACK-KLS



Tacker sheet with EPS insulation, foil with 100 x 100 mm grid marking and overlap, acoustic improvement

Tacker klapset met EPS isolatie voorzien van folie met raster 100 x 100 mm en overlap, geluidsverbetering

Plaque tacker en isolation EPS, film avec trame 100 x 100 mm et rabat, isolant acoustique

Verbundplatte aus Styropordämmung mit Folie Masche 100 x 100 mm und Überschneidung, Trittschallverbesserung

Article number	Packing	Type
UFH-TACK-KLS15	10 m <sup>2</sup> (5 x 2 m <sup>2</sup> )	1000x2000x15mm - 4kPa - 17dB
UFH-TACK-KLS20	10 m <sup>2</sup> (5 x 2 m <sup>2</sup> )	1000x2000x20mm - 4kPa - 33dB
UFH-TACK-KLS25	10 m <sup>2</sup> (5 x 2 m <sup>2</sup> )	1000x2000x25mm - 4kPa - 33dB
UFH-TACK-KLS30	10 m <sup>2</sup> (5 x 2 m <sup>2</sup> )	1000x2000x30mm - 4kPa - 33dB



## Type: UFH-TACK-ROL



Tacker roll with EPS insulation, foil with marking 100 x 100 mm and overlap, up to 29dB acoustic improvement

Tacker rol met EPS isolatie voorzien van folie met raster 100 x 100 mm en overlap, tot 29dB geluidsverbetering

Rouleau tacker en isolation EPS, film plastique avec trame 100 x 100 mm et rabat, isolant acoustique jusqu'à 29dB

Roll-Dämmung aus Styropor mit Folie 100 x 100 mm und Überschneidung, Trittschallverbesserung bis 29dB

Article number	Packing	Type
UFH-TACK-ROL20	10 m <sup>2</sup> (1 x 10 m <sup>2</sup> )	1000x10.000x20mm - 4kPa - 28dB
UFH-TACK-ROL25	10 m <sup>2</sup> (1 x 10 m <sup>2</sup> )	1000x10.000x25mm - 4kPa - 28dB
UFH-TACK-ROL30	10 m <sup>2</sup> (1 x 10 m <sup>2</sup> )	1000x10.000x30mm - 4kPa - 29dB
UFH-TACK-ROL35	10 m <sup>2</sup> (1 x 10 m <sup>2</sup> )	1000x10.000x35mm - 4kPa - 29dB

## Type: UFH-TACK-38K



Tacker clip, 38 mm

Tackernagel, 38 mm

Agrafe tacker, 38 mm

Tackernadel, 38 mm

Article number	Box / Big Box	Type
UFH-TACK-38K *	300 pc. / 6000 pc.	38 mm

\* Pipe Ø 16

## Type: UFH-TACK-40



Tacker clip, 40 mm

Tackernagel, 40 mm

Agrafe tacker, 40 mm

Tackernadel, 40 mm

Article number	Box / Big Box	Type
UFH-TACK-40 *	300 pc. / 8.400 pc.	40 mm

\* Pipe Ø 16-20

## Type: UFH-TACK-60



Tacker clip, 60 mm

Tackernagel, 60 mm

Agrafe tacker, 60 mm

Tackernadel, 60 mm

Article number	Box / Big Box	Type
UFH-TACK-60 *	300 pc. / 6.000 pc.	60 mm

\* Pipe Ø 16-20

### Type: UFH-TACK



Tacker machine for UFH-TACK-40, UFH-TACK-60  
 Tackerapparaat voor UFH-TACK-40, UFH-TACK-60  
 Appareil Tacker pour UFH-TACK-40, UFH-TACK-60  
 Tackergerät für UFH-TACK-40, UFH-TACK-60

Article number	Packing	Type
UFH-TACK	1 pc.	for UFH-TACK-40 / UFH-TACK-60

### Type: UFH-SCOTCH-66



Adhesive tape  
 Kleefband  
 Ruban adhésif  
 Klebeband

Article number	Packing	Type
UFH-SCOTCH-66	1 pc.	66 m

### Type: UFH-P18-GP18



Gypsum fibreboard 18mm, round milling for RENO12 system  
 Gipsvezelplaat 18mm, ronde frezing voor RENO12 systeem  
 Plaques en fibro-plâtre 18mm, avec une fraisure circulaire système RENO12  
 Gipsfaserplatte 18mm, runde Fräsung für das RENO12 system

Article number	pc	Type
UFH-P18-GP18	1 pc.	1000 x 600 x 18mm

### Type: UFH-P18-GP18V



Gypsum fibreboard 18mm, vertical milling for RENO12 system  
 Gipsvezelplaat 18mm, verticale frezing voor RENO12 systeem  
 Plaques en fibro-plâtre 18mm, système RENO12  
 Gipsfaserplatte 18mm, vertikale Fräsung für das RENO12 system

Article number	pc	Type
UFH-P18-GP18V	1 pc.	1000 x 600 x 18mm



## Type: UFH-P18-GP10



Gypsum fibreboard 10mm, flat for RENO12 system  
 Gipsvezelplaat 10mm, vlak voor RENO12 systeem  
 Plaques en fibro-plâtre 10mm, système RENO12  
 Gipsfaserplatte 10mm, flach für das RENO12 system

Article number	pc	Type
UFH-P18-GP10	1 pc.	1500 x 1000 x 10mm

## Type: UFH-P18-WN



Mesh for RENO12 system  
 Wapeningsnet voor RENO12 systeem  
 Treillis d'armature système RENO12  
 Betonstahlmatte für das RENO12 system

Article number	Packing	Type
UFH-P18-WN	50 m <sup>2</sup>	1 x 50m

## Type: UFH-ISODRY-25



Insulation system board for dry system  
 Isolatieplaat voor droog systeem  
 Panneau d'isolation pour système sec  
 Systemplatte für Trockenbau

Article number	Packing	Type
UFH-ISODRY-25	10 m <sup>2</sup>	1000x500x25mm

## Type: UFH-DRY-GP100-2



Heat diffusion profile for dry system  
 Stralingsprofiel voor droog systeem  
 Profil de diffusion pour système sec  
 Wärmeleitlamelle für Trockenbau

Article number	Packing	Type
UFH-DRY-GP100-2	50 pc.	997x120x0,4mm - Ø16

- 1
- 2
- 3
- 4
- 5
- 6
- 7
- 8
- 9
- 10
- 11

## Type: UFH-DRY-VD100



Heat diffusion board for dry system  
Stralingsverdeelplaat voor droog systeem  
Panneau de diffusion pour système sec  
Verteillerbleche für Trockenbau

Article number	Packing	Type
UFH-DRY-VD100	1 pc.	1000x1000mm

## Type: UFH-DRY-B



Synthetic mounting bracket for pipe in diagonal position  
kunststofbeugel voor bevestiging buis bij diagonaalverlegging  
Fixation en plastique pour pose du tube diagonal  
Kunststoffreiter für Diagonalverlegung

Article number	Packing	Type
UFH-DRY-B	100	

## Type: UFH-UP-M



Clip rail with adhesive strip, centres 50 mm  
U-profiel met kleefband, verlegafstand 50 mm  
Profil-U avec bande adhésif, distance de pose 50 mm  
Kunststoffclip-Schiene klebfertig für Rohr, Verlegung 50 mm

Article number	Box / Pallet	Type
UFH-UP-14M1	100 m / 1000 m	Ø14 - AS 25 mm- 1000 mm
UFH-UP-16M1	100 m / 1000 m	Ø16 - AS 50 mm- 1000 mm

## Type: UFH-UP



Clip rail with adhesive strip, centres 50 mm  
U-profiel met kleefband, verlegafstand 50 mm  
Profil-U avec bande adhésif, distance de pose 50 mm  
Kunststoffclip-Schiene klebfertig für Rohr, Verlegung 50 mm

Article number	Box / Pallet	Type
UFH-UP-12	32 m / 960 m	Ø12 - AS 25 mm- 2000 mm
UFH-UP-14	100 m / 2500 m	Ø14 - AS 25 mm- 2500 mm
UFH-UP-16	100 m / 3000 m	Ø16 - AS 50 mm- 2500 mm
UFH-UP-20	100 m / 896 m	Ø20 - AS 50 mm- 2000 mm





## Type: UFH-UP-Z



Clip rail without adhesive strip, centres 50 mm  
 U-profiel zonder kleefband, verlegafstand 50 mm  
 Profil-U sans bande adhésif, distance de pose 50 mm  
 Kunststoffclip-Schiene nicht klebfertig, Verlegung 50 mm

Article number	Box / Pallet	Type
UFH-UP-1826M1Z	50 m / 600 m	Ø18, 20, 26 - AS 50 mm - 1000

## Type: UFH-UP-CUP



Staple for clip rail  
 Clip voor U-profielen  
 Agrafe pour profil-U  
 Nadel für Schienen

Article number	Box / Big Box	Type
UFH-UP-CUP50	500 pc. / 9000 pc.	50 mm

## Type: UFH-FOIL



PE film, transparant, with blue grid marking 50 x 50 mm  
 PE-folie, transparant, blauwe rastermarkering 50 x 50 mm  
 Film en PE, transparent avec marquage 50 x 50 mm en bleu  
 Polyethylen-Schutzfolie, transparent, Markierung Blau 50x50mm

Article number	Packing	Type
UFH-FOIL50	51 m <sup>2</sup>	34m x 1,5m - 0,2mm
UFH-FOIL90	90 m <sup>2</sup>	60m x 1,5m - 0,2mm

## Type: UFH-FOIL-N



PE film, neutral  
 PE-folie, neutraal  
 Film en PE, neutre  
 Polyethylen-Schutzfolie, neutral

Article number	Packing	Type
UFH-FOIL-N	100 m <sup>2</sup>	50 m x 2 m - 0,2 mm

- 1
- 2
- 3
- 4
- 5
- 6
- 7
- 8
- 9
- 10
- 11

## Type: UFH-FOIL-ALU



PE film, reflecting ALU  
 PE-folie, met PE-flap en ALU reflectie  
 Film en PE avec réflexion ALU  
 Polyethylen-Schutzfolie, Refltion ALU

Article number	Packing	Type
UFH-FOIL-ALU	50 m <sup>2</sup>	50 m x 1 m - 3,0 mm

## Type: UFH-FOIL-CLIP25



Clip for Film  
 Dampfolienagel  
 Agrafe pour film PE  
 Foliendübel

Article number	Packing	Type
UFH-FOIL-CLIP25	100 pc.	25 mm

## Type: UFH-PLUG80



Plug, shaft length 80 mm, Ø8 mm  
 Montageplug, schachtlengte 80 mm, Ø8 mm  
 Cheville de montage, longueur 80 mm, Ø8 mm  
 Niederhaltedübel, Bohrer Ø 8 mm, Schaftlänge 80 mm

Article number	Packing	Type
UFH-PLUG80	100 pc.	80 mm, Ø8 mm

## Type: UFH-ISOBOARD-S



PE edge isolation with lapping strip and adhesive strip  
 Randisolatie uit PE-schuim met PE-flap en kleefstroken  
 Isolation périphérique en PE avec rabat et bande adhésif  
 Randdämmstreifen aus PE mit Abrisskante und Klebestreifen

Article number	Packing	Type
UFH-ISOBOARD-S	25 m	150 x 8 mm



## Type: UFH-ISOBOARD-GV



PE edge isolation with lapping strip and adhesive strip for liquid floors  
 Randisolatie voor gietvloeren uit PE-schuim met flap en kleefstroken  
 Isolation périphérique en PE avec rabat et bande adhésif, pour chape anhydrite  
 Randdämmstreifen aus PE mit Abrisskante und Klebestreifen, für Fliessestrich

Article number	Packing	Type
UFH-ISOBOARD-GV	25 m	150 mm x 8 mm

## Type: UFH-DP200



PE expansion joint with self-adhesive rail  
 Uitzettingsvoeg uit PE-schuim met zelfklevende rail  
 Joint de dilatation en PE avec bande adhésive  
 Dehnungsfuge aus PE mit Klebestreifen

Article number	Packing	Type
UFH-DP200	2 m	2000 mm x 100 mm x 8 mm

## Type: UFH-DH40



Protection sleeve for expansion joint  
 Voegdoorganghuls  
 Gaine de protection pour joint de dilatation  
 Schutzrohre für Dehnungsfugen

Article number	Packing	Type
UFH-DH40	100 pc.	400 mm

## Type: UFH-BEND



Bend guide for pipe  
 Geleidingsbocht voor buis  
 Courbe pour tube  
 Rohrführungsbogen

Article number	Packing	Type
UFH-BEND1218	1 pc.	Ø 12 - 18 mm
UFH-BEND20	1 pc.	Ø 20 mm

- 1
- 2
- 3
- 4
- 5
- 6
- 7
- 8
- 9
- 10
- 11

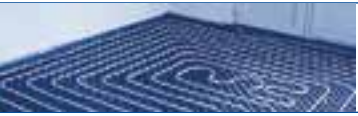

## A. SYSTEMS

### Type: UFH-ADN10



Additive for screed (min. pipe covering 45 mm)

Toevoegmiddel voor zandcementvloer (min. buisoverdking 45 mm)

Additif pour chape de ciment (min. épaisseur de chape au-dessus du tube 45 mm)

Estrichzusatz (min. Rohrüberdeckung 45 mm)

Article number	Packing	Type
UFH-ADN10	10 L	

- 1
- 2
- 3
- 4
- 5
- 6
- 7
- 8
- 9
- 10
- 11

## B. MANIFOLDS



### Type: UFH-06-MD



**Manifold brass, adjustable, with flow meters**  
**Verdeler messing, regelbaar, met debietmeting**  
**Collecteur en laiton, réglable, avec débitmètres**  
**Verteiler aus Messing, regelbar, mit Durchflussmengenmesser**

Article number	Packing	Type
UFH-060502-MD	1 pc.	1"M - 2 x 3/4"
UFH-060503-MD	1 pc.	1"M - 3 x 3/4"
UFH-060504-MD	1 pc.	1"M - 4 x 3/4"
UFH-060505-MD	1 pc.	1"M - 5 x 3/4"
UFH-060506-MD	1 pc.	1"M - 6 x 3/4"
UFH-060507-MD	1 pc.	1"M - 7 x 3/4"
UFH-060508-MD	1 pc.	1"M - 8 x 3/4"
UFH-060509-MD	1 pc.	1"M - 9 x 3/4"
UFH-060510-MD	1 pc.	1"M - 10 x 3/4"
UFH-060511-MD	1 pc.	1"M - 11 x 3/4"
UFH-060512-MD	1 pc.	1"M - 12 x 3/4"

### Type: UFH-M-D



**Flow meter for brass manifold**  
**Debietmeter voor messing verdeler**  
**Débitmètre pour collecteur en laiton**  
**Durchflussmengenanzeiger für Verteiler aus Messing**

Article number	Packing	Type
UFH-M-D	1 pc.	

### Type: UFH-PGKTA



**Pump unit A label pump with consistent temperature control**  
**Pompgroep A-label met regeling voor constante temperatuur**  
**Kit pompe label A avec régulation de température constante**  
**Konstanttemperaturregelung mit A-Pumpe**

Article number	Packing	Type
UFH-PGKTA	1 pc.	1"F / 27°C - 42°C

## B. MANIFOLDS

### Type: UFH-PGKTA-TH



Thermostatic sensor UFH-PGKTA  
 Thermostaat kop voor UFH-PGKTA  
 Tête thermostatique UFH-PGKTA  
 Thermostatkopf UFH-PGKTA

Article number	Packing	Type
UFH-PGKTA-TH	1 pc.	

### Type: UFH-GKT



Unit with consistent temperature control without pump  
 Groep met regeling voor constante temperatuur zonder pomp  
 Kit avec régulation de température constante sans pompe  
 Konstanttemperaturregelung ohne Pump

Article number	Packing	Type
UFH-GKT	1 pc.	1" F / 27°C - 42°C

### Type: UFH-BT-M



1" F ball valve with 1" F swivel nut, washer and thermometer  
 Kogelkraan 1" F met wartelmoer 1" F , dichting en thermometer  
 Vanne à sphère 1" F avec écrou 1" F, joint et thermomètre  
 Kugelhahnset 1" IG mit Mutter 1" IG , Dichtung und Thermometer

Article number	Packing	Type
UFH-BTM0606-M	1 set (2 pc.)	1" F x 1" F / 0 - 60 °

### Type: UFH-B-M



1" F ball valve with 1" F swivel nut and washer  
 Kogelkraan 1" F met wartelmoer 1" F en dichting  
 Vanne à sphère 1" F avec écrou 1" F et joint plat  
 Kugelhahnset 1" IG mit Mutter 1" IG und Dichtung

Article number	Packing	Type
UFH-B0606-M	1 set (2 pc.)	1" F x 1" F

## B. MANIFOLDS



### Type: UFH-ESK-M



1" F end cap with nut, washer, ball valve and air vent 3/8"  
 Eindstuk 1" F met moer, dichting, kogelkraan en ontluftingskraan 3/8"  
 Bouchon terminal 1" F avec écrou, vanne à sphère, joint et purgeur 3/8"  
 Verteilerendstückset 1" IG mit Mutter und Dichtung, Enlüftung 3/8", Kugelhahnset, Entleerung 1/2"

Article number	Packing	Type
UFH-ESK060303-M	1 set (2 pc.)	1" F x 1/2" x 3/8"

### Type: UFH-AO-MZ



Automatic air vent, without check valve  
 Automatische ontlufter, zonder waterslot  
 Purgeur automatique, sans serrure d'eau  
 Schnellentlüfter mit vertikaler Entlüftung, ohne Wasserabspernung

Article number	Packing	Type
UFH-AO03-MZ	1 pc.	3/8"

### Type: UFH-TM-M



Thermometer for return with EK connections  
 Thermometer voor terugvoer met euroconus aansluitingen  
 Retour thermomètre avec raccordement eurocone  
 Thermometer zum Anschluss Rücklauf mit Eurokonus-Anschlüssen

Article number	Packing	Type
UFH-TM050-M	1 pc.	3/4" - 3/4" EK / 0

### Type: UFH-BS-M



End cap with washer  
 Blindstop  
 Bouchon  
 Kappe mit Dichtung

Article number	Packing	Type
UFH-BS05-M	1 pc.	3/4"

## B. MANIFOLDS

### Type: UFH-MDSS



Stainless steel manifold  
Roestvrij stalen verdeler  
Distributeur en acier inoxydable  
Edelstahlverteiler

Article number	Packing	Type
■ UFH-0605MDSS02	1 pc.	1" - 2 x 3/4"
■ UFH-0605MDSS03	1 pc.	1" - 3 x 3/4"
■ UFH-0605MDSS04	1 pc.	1" - 4 x 3/4"
■ UFH-0605MDSS05	1 pc.	1" - 5 x 3/4"
■ UFH-0605MDSS06	1 pc.	1" - 6 x 3/4"
■ UFH-0605MDSS07	1 pc.	1" - 7 x 3/4"
■ UFH-0605MDSS08	1 pc.	1" - 8 x 3/4"
■ UFH-0605MDSS09	1 pc.	1" - 9 x 3/4"
■ UFH-0605MDSS10	1 pc.	1" - 10 x 3/4"
■ UFH-0605MDSS11	1 pc.	1" - 11 x 3/4"
■ UFH-0605MDSS12	1 pc.	1" - 12 x 3/4"
■ UFH-0605MDSS13	1 pc.	1" - 13 x 3/4"
■ UFH-0605MDSS14	1 pc.	1" - 14 x 3/4"
■ UFH-0605MDSS15	1 pc.	1" - 15 x 3/4"

### Type: UFH-BT-VN



1" F ball valve with 1" F swivel nut, washer and thermometer, nickel-plated  
Kogelkraan 1" F met wartelmoer 1" F, dichting en thermometer, vernikkeld  
Vanne à sphère 1" F avec écrou 1" F, joint et thermomètre, nickelé  
Kugelhahnset 1" IG mit Mutter 1" IG, Dichtung und Thermometer, vernickelt

Article number	Packing	Type
UFH-BTM0606-VN	1 set (2 pc.)	1" F x 1" F

### Type: UFH-B-VN



1" F ball valve with 1" F swivel nut and washer, nickel-plated  
Kogelkraan 1" F met wartelmoer 1" F en dichting, vernikkeld  
Vanne à sphère 1" F avec écrou 1" F et joint, nickelé  
Kugelhahnset 1" IG mit Mutter 1" IG und Dichtung, vernickelt

Article number	Packing	Type
UFH-B0606-VN	1 set (2 pc.)	1" F x 1" F / 0 - 60 °

### Type: UFH-ESK-VN



1" F end cap with nut, washer, ball valve and air vent 3/8", nickel-plated  
Eindstuk 1" F met moer, dichting, kogelkraan en ontluftingskraan 3/8", vernikkeld  
Bouchon terminal 1" F avec écrou, joint et purgeur 3/8", nickelé  
Verteilerendstückset 1" IG mit Mutter und Dichtung, Entlüftung 3/8", Kugelhahnset, vernickelt

Article number	Packing	Type
UFH-ESK060303-VN	1 set (2 pc.)	1" F x 1/2" x 3/8"



## B. MANIFOLDS



### Type: UFH-MDK

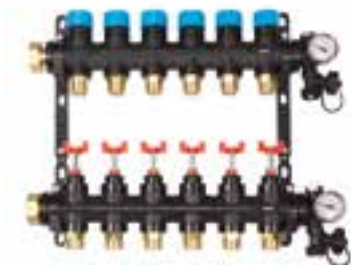

Manifold composite, adjustable with flow meter, thermometer washer and air vent  
 Composiet verdeler, regelbaar met debietmeting, thermometer, vul- en aftapkraan, ontluchter

Collecteur composite, réglable avec débitmètre, thermomètre, purge et purgeur d'air

Verteiler Composite, regelbar mit Durchflussmengenmesser, Thermomesser, Entleerung und Entlüfter

Article number	Packing	Type
UFH-0605MDK02	1 pc.	1" - 2 x 3/4"
UFH-0605MDK03	1 pc.	1" - 3 x 3/4"
UFH-0605MDK04	1 pc.	1" - 4 x 3/4"
UFH-0605MDK05	1 pc.	1" - 5 x 3/4"
UFH-0605MDK06	1 pc.	1" - 6 x 3/4"
UFH-0605MDK07	1 pc.	1" - 7 x 3/4"
UFH-0605MDK08	1 pc.	1" - 8 x 3/4"
UFH-0605MDK09	1 pc.	1" - 9 x 3/4"
UFH-0605MDK10	1 pc.	1" - 10 x 3/4"
UFH-0605MDK11	1 pc.	1" - 11 x 3/4"
UFH-0605MDK12	1 pc.	1" - 12 x 3/4"

### Type: UFH-MDK-CON



Composite connector for MDK manifold

Composiet verbinder voor MDK verdeler

Connecteur en composite pour collecteur MDK

Composiet Verbinder für MDK Verteiler

Article number	Bag / Box	Type
UFH-MDK-CON	1 pc. / 50 pc.	

### Type: UFH-BM-VN



Ball valve with gasket, nickel-plated

Kogelkraan met dichting, vernikkeld

Vanne à sphère et joint, nickelé

Kugelhahnset, vernickelt

Article number	Packing	Type
UFH-B0605-VN	1 set (2 pc.)	3/4" x 1"
UFH-BM0606-VN	1 set (2 pc.)	1" x 1"

## B. MANIFOLDS

### Type: UFH-CDP

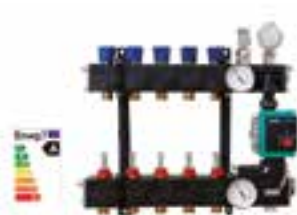

**Manifold composite, adjustable with flow meter and A-pump**  
**Composiet verdeler, regelbaar met debietmeting en A-pomp**  
**Collecteur composite, réglable avec débitmètre et pompe label A**  
**Verteiler Composite, regelbar mit Durchflussmengenmesser und A-Pumpe**

Article number	Packing	Type
UFH-0405CDP01	1 pc.	1/2" - 1 x 3/4"
UFH-0405CDP02	1 pc.	1/2" - 2 x 3/4"
UFH-0405CDP03	1 pc.	1/2" - 3 x 3/4"
UFH-0405CDP04	1 pc.	1/2" - 4 x 3/4"
UFH-0405CDP05	1 pc.	1/2" - 5 x 3/4"
UFH-0405CDP06	1 pc.	1/2" - 6 x 3/4"
UFH-0505CDP07	1 pc.	3/4" - 7 x 3/4"
UFH-0505CDP08	1 pc.	3/4" - 8 x 3/4"
UFH-0505CDP09	1 pc.	3/4" - 9 x 3/4"
UFH-0505CDP10	1 pc.	3/4" - 10 x 3/4"
UFH-0505CDP11	1 pc.	3/4" - 11 x 3/4"
UFH-0505CDP12	1 pc.	3/4" - 12 x 3/4"
UFH-0505CDP13	1 pc.	3/4" - 13 x 3/4"
UFH-0505CDP14	1 pc.	3/4" - 14 x 3/4"
UFH-0505CDP15	1 pc.	3/4" - 15 x 3/4"
UFH-0505CDP16	1 pc.	3/4" - 16 x 3/4"

*Also available with Active Flow Control*

### Type: UFH-CD

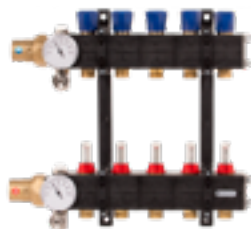

**Manifold composite, adjustable with flow meter**  
**Composiet verdeler, regelbaar met debietmeting**  
**Collecteur composite, réglable avec débitmètre**  
**Verteiler Composite, regelbar mit Durchflussmengenmesser**

Article number	Packing	Type
UFH-0605CD01	1 pc.	1" - 1 x 3/4"
UFH-0605CD02	1 pc.	1" - 2 x 3/4"
UFH-0605CD03	1 pc.	1" - 3 x 3/4"
UFH-0605CD04	1 pc.	1" - 4 x 3/4"
UFH-0605CD05	1 pc.	1" - 5 x 3/4"
UFH-0605CD06	1 pc.	1" - 6 x 3/4"
UFH-0605CD07	1 pc.	1" - 7 x 3/4"
UFH-0605CD08	1 pc.	1" - 8 x 3/4"
UFH-0605CD09	1 pc.	1" - 9 x 3/4"
UFH-0605CD10	1 pc.	1" - 10 x 3/4"
UFH-0605CD11	1 pc.	1" - 11 x 3/4"
UFH-0605CD12	1 pc.	1" - 12 x 3/4"
UFH-0605CD13	1 pc.	1" - 13 x 3/4"
UFH-0605CD14	1 pc.	1" - 14 x 3/4"
UFH-0605CD15	1 pc.	1" - 15 x 3/4"
UFH-0605CD16	1 pc.	1" - 16 x 3/4"
UFH-0605CD17	1 pc.	1" - 17 x 3/4"
UFH-0605CD18	1 pc.	1" - 18 x 3/4"
UFH-0605CD19	1 pc.	1" - 19 x 3/4"
UFH-0605CD20	1 pc.	1" - 20 x 3/4"

*Also available with Active Flow Control*

## B. MANIFOLDS



### Type: UFH-CAF



Manifold composite, adjustable with active flow control  
 Composiet verdeler, regelbaar met active flow control  
 Collecteur composite, réglable avec active flow control  
 Verteiler Composite, regelbar mit active flow control

Article number	Packing	Type
UFH-0605CAF01	1 pc.	1" - 1 x 3/4"
UFH-0605CAF04	1 pc.	1" - 4 x 3/4"

TILL EXHAUSTION OF STOCK

### Type: UFH-CDWE



Manifold composite project che with heat exchanger and dirt separator  
 Composiet verdeler project cwe met warmtewisselaar en vuilafscheider  
 Collecteur composite projet cev avec échangeur de chaleur et séparateur de boue  
 Verteiler Composite projt cwa mit Wärmetauscher und Schlammabscheider

Article number	Packing	Type
UFH-0505CDWE01	1 pc.	3/4" - 1 x 3/4"
UFH-0505CDWE06	1 pc.	3/4" - 6 x 3/4"
UFH-0505CDWE08	1 pc.	3/4" - 8 x 3/4"
UFH-0505CDWE09	1 pc.	3/4" - 9 x 3/4"

TILL EXHAUSTION OF STOCK

### Type: UFH-CP



A-pump unit for composite collector  
 Pompunit composiet verdeler, met A-pomp  
 Kit pompe-A pour collecteur composite  
 A-Pump Unit für Composite Verteiler

Article number	Packing	Type
UFH-CP	1 pc.	

## B. MANIFOLDS

### Type: UFH-SECO



**Steel collector with A-pump**  
**Stalen verdeler met A-pomp**  
**Collecteur en acier avec pompe label A**  
**Verteiler Stahl mit A-Pump**

Article number	Packing	Type
UFH-0405SECO01	1 pc.	1/2" - 1 x 3/4"
UFH-0405SECO02	1 pc.	1/2" - 2 x 3/4"
UFH-0405SECO03	1 pc.	1/2" - 3 x 3/4"
UFH-0405SECO04	1 pc.	1/2" - 4 x 3/4"
UFH-0405SECO05	1 pc.	1/2" - 5 x 3/4"
UFH-0405SECO06	1 pc.	1/2" - 6 x 3/4"
UFH-0505SECO07	1 pc.	3/4" - 7 x 3/4"
UFH-0505SECO08	1 pc.	3/4" - 8 x 3/4"
UFH-0505SECO09	1 pc.	3/4" - 9 x 3/4"
UFH-0505SECO10	1 pc.	3/4" - 10 x 3/4"
UFH-0505SECO11	1 pc.	3/4" - 11 x 3/4"
UFH-0505SECO12	1 pc.	3/4" - 12 x 3/4"
UFH-0505SECO13	1 pc.	3/4" - 13 x 3/4"
UFH-0505SECO14	1 pc.	3/4" - 14 x 3/4"
UFH-0505SECO15	1 pc.	3/4" - 15 x 3/4"
UFH-0505SECO16	1 pc.	3/4" - 16 x 3/4"

### Type: UFH-SSTN



**Steel collector with pump, district heating nuon and eneco**  
**Stalen verdeler met pomp, stadsverwarming nuon en eneco**  
**Collecteur en acier avec pompe, chauffage urbain nuon et eneco**  
**Verteiler Stahl mit Pump, Fernheizung nuon und eneco**

Article number	Packing	Type
UFH-0405SSTN01	1 pc.	1/2" - 1 x 3/4"
UFH-0405SSTN02	1 pc.	1/2" - 2 x 3/4"
UFH-0405SSTN03	1 pc.	1/2" - 3 x 3/4"
UFH-0405SSTN04	1 pc.	1/2" - 4 x 3/4"
UFH-0405SSTN05	1 pc.	1/2" - 5 x 3/4"
UFH-0405SSTN06	1 pc.	1/2" - 6 x 3/4"
UFH-0505SSTN07	1 pc.	3/4" - 7 x 3/4"
UFH-0505SSTN08	1 pc.	3/4" - 8 x 3/4"
UFH-0505SSTN09	1 pc.	3/4" - 9 x 3/4"
UFH-0505SSTN10	1 pc.	3/4" - 10 x 3/4"
UFH-0505SSTN11	1 pc.	3/4" - 11 x 3/4"
UFH-0505SSTN12	1 pc.	3/4" - 12 x 3/4"

## B. MANIFOLDS



### Type: UFH-SSTE



Steel collector with pump, district heating essent  
 Stalen verdeler met pomp, stadsverwarming essent  
 Collecteur en acier avec pompe, chauffage urbain essent  
 Verteiler Stahl mit Pump, Fernheizung essent

Article number	Packing	Type
UFH-0405SSTE01	1 pc.	1/2" - 1 x 3/4"
UFH-0405SSTE02	1 pc.	1/2" - 2 x 3/4"
UFH-0405SSTE03	1 pc.	1/2" - 3 x 3/4"
UFH-0405SSTE04	1 pc.	1/2" - 4 x 3/4"
UFH-0405SSTE05	1 pc.	1/2" - 5 x 3/4"
UFH-0405SSTE06	1 pc.	1/2" - 6 x 3/4"
UFH-0505SSTE07	1 pc.	3/4" - 7 x 3/4"
UFH-0505SSTE08	1 pc.	3/4" - 8 x 3/4"
UFH-0505SSTE09	1 pc.	3/4" - 9 x 3/4"
UFH-0505SSTE10	1 pc.	3/4" - 10 x 3/4"
UFH-0505SSTE11	1 pc.	3/4" - 11 x 3/4"
UFH-0505SSTE12	1 pc.	3/4" - 12 x 3/4"

### Type: UFH-LTV

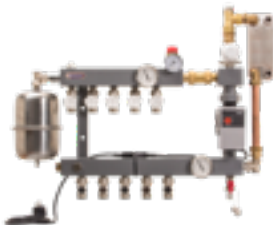

Steel collector with A-pump and plate heat exchanger (low temperature)  
 Stalen verdeler met A-pomp en scheidingswisselaar voor LT toepassing  
 Collecteur en acier avec pompe label A et échangeur à plaques (temperature basse)  
 Verteiler Stahl mit A-Pump und Plattenwärmetauscher (niedrigen Temperaturen)

Article number	Packing	Type
UFH-0405LTV01	1 pc.	1/2" - 1 x 3/4"
UFH-0405LTV02	1 pc.	1/2" - 2 x 3/4"
UFH-0405LTV03	1 pc.	1/2" - 3 x 3/4"
UFH-0405LTV04	1 pc.	1/2" - 4 x 3/4"
UFH-0405LTV05	1 pc.	1/2" - 5 x 3/4"
UFH-0405LTV06	1 pc.	1/2" - 6 x 3/4"
UFH-0505LTV07	1 pc.	3/4" - 7 x 3/4"
UFH-0505LTV08	1 pc.	3/4" - 8 x 3/4"
UFH-0505LTV09	1 pc.	3/4" - 9 x 3/4"
UFH-0505LTV10	1 pc.	3/4" - 10 x 3/4"
UFH-0505LTV11	1 pc.	3/4" - 11 x 3/4"
UFH-0505LTV12	1 pc.	3/4" - 12 x 3/4"

## B. MANIFOLDS

### Type: UFH-MAXB55



Maximum temperature safety cut-out switch  
 Maximaalbeveiligingsschakelaar  
 Interrupteur de protection maximal  
 Maximalschutzschalter

Article number	Packing	Type
UFH-MAXB55	1 pc.	Max. 55 °C

*TILL EXHAUSTION OF STOCK*

### Type: UFH-MAX95



Maximum temperature safety cut-out switch 50 -95°C  
 Maximaalthermostaat, 50 - 95°C  
 Thermostat de sécurité, 50 - 95 °C  
 Maximalschutzschalter, 50 - 95 °C

Article number	Packing	Type
UFH-MAX95	1 pc.	50 - 95°C - 15A / 230V

*TILL EXHAUSTION OF STOCK*

### Type: UFH-C191645



Thermostatic sensor 10/60°C with short probe  
 Thermostaat voeler 10/60°C met korte sensor  
 Tête thermostatique 10/60°C avec senseur court  
 Thermostat 10/60°C mit kurze Fühler

Article number	Packing	Type
UFH-C191645		

### Type: UFH-C191974 - 76



Circulator Wilo Yonos Para RS 15/6-RKA KU 130mm (excl. wire/plug)  
 Circulator Wilo Yonos Para RS 15/6-RKA KU 130mm (excl. snoer/stekker)  
 Circulateur Wilo Yonos Para RS 15/6-RKA KU 130mm (excl. fil/prise)  
 Cirkulator Wilo Yonos Para RS 15/6-RKA KU 130mm (excl. Snur/Stecker)

Article number	Packing	Type
UFH-C191974		1"
UFH-C191976		1 1/2"

## B. MANIFOLDS



### Type: UFH-C192071



Safety thermostat incl. wire/plug  
Maximaal thermostaat incl. snoer/stekker  
Thermostat de sécurité incl. fil/prise  
Maximal Thermostat incl. Snur/Stecker

Article number	Packing	Type
UFH-C192071	1 pc.	

### Type: UFH-C191800



Thermometer with immersion sleeve 0/60 gr.  
Thermometer met dompelbuis temp 0/60 gr.  
Thermomètre temp. 0/60 gr. avec bulbe  
Thermometer mit Tauchhülse 0/60 gr.

Article number	Packing	Type
UFH-C191800	1 pc.	

1

2

3

4

5

6

7

8

9

10

11

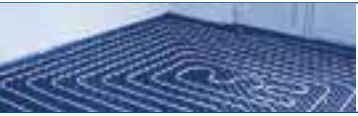

## C. CONTROL UNITS

- 1 WIRED CONTROL UNIT
- 2 BEKABELDE ZONEREGELING
- 3 RÉGULATEURS DE ZONE CÂBLÉS
- 4
- 5
- 6
- 7
- 8
- 9
- 10
- 11

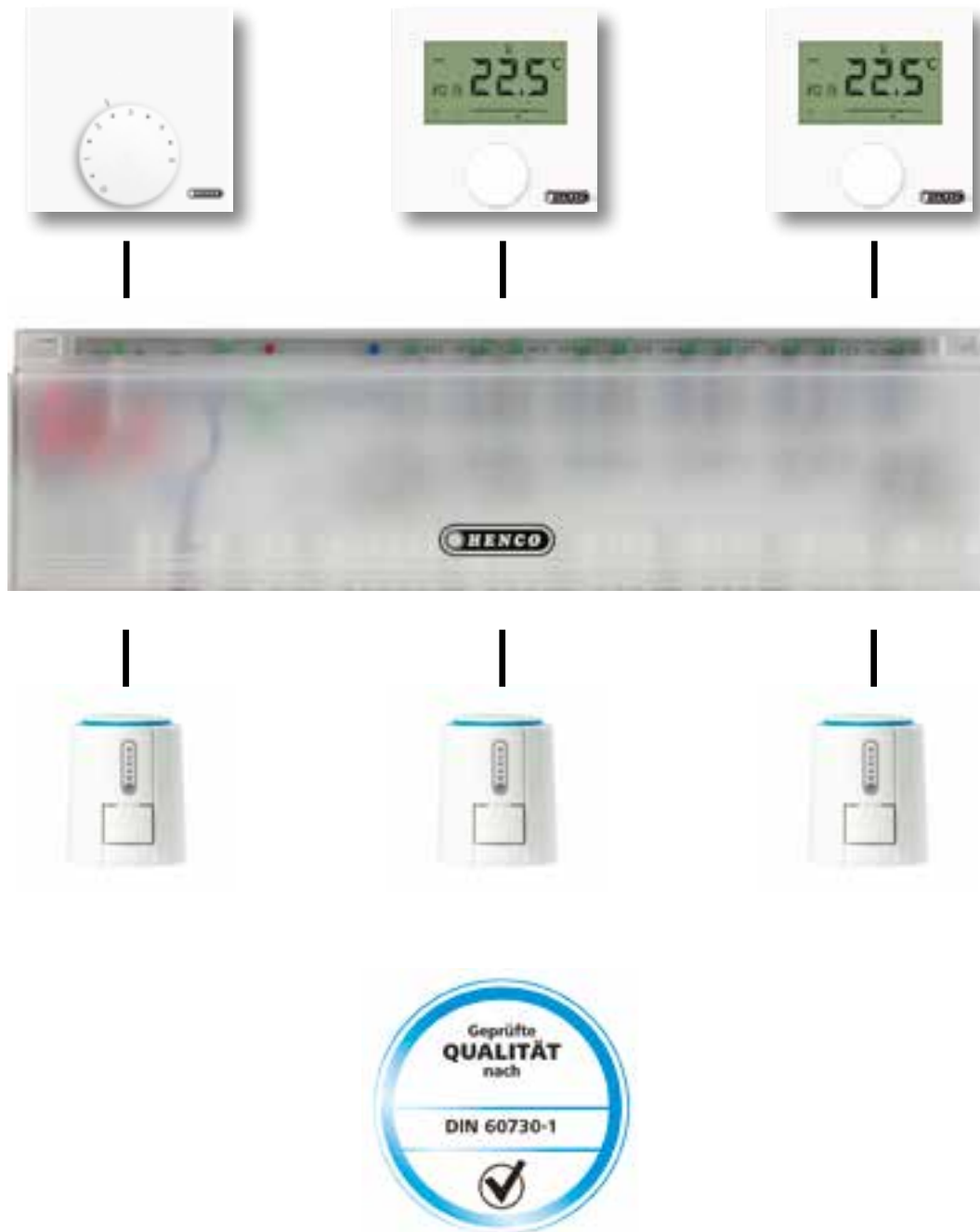



## C. CONTROL UNITS



### Type: CU-6ZONE-24V



Base module 6 zones, 24V transformator incl.  
Basisstation 6 zonen, 24V transformator incl.  
Base module 6 zones, 24V transformator incl.  
Regelklemmleiste 6-Zonen, Basic, 24V incl Transformator.

Article number	Packing	Type
CU-6ZONE-24V	1 pc.	

### Type: CU-6ZONE-230V

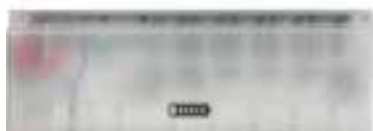

Base module 6 zones, 230V  
Basismodule 6 zones, 230V  
Module de base 6 zones, 230V  
Regelklemmleiste 6-Zonen, Basic, 230V

Article number	Packing	Type
CU-6ZONE-230V	1 pc.	

### Type: CU-DINRAIL



Din rail  
Din rail  
Din rail  
Befestigungsschiene für Regelklemmleiste

Article number	Packing	Type
CU-DINRAIL	1 pc.	

### Type: CU-6ZONEP-24V



Base module Plus 6 zones, 24V transformator incl. (heating/cooling with pump contact)  
Basisstation Plus 6 zonen, 24V transformator incl. (verwarmen/koelen met pompsturing)  
Base module Plus 6 zones, 24V transformator incl. (chauffer/refroidir avec contact circulateur)  
Regelklemmleiste Plus 6-Zonen, Basic, 24V incl Transformator. (Heizung/Kühlung mit Pumpensteuerung)

Article number	Packing	Type
CU-6ZONEP-24V	1 pc.	

## C. CONTROL UNITS

### Type: CU-6ZONEP-230V



Base module Plus 6 zones, 230V transformator incl. (heating/cooling with pump contact)

Basisstation Plus 6 zonen, 230V transformator incl. (verwarmen/koelen met pompsturing)

Base module Plus 6 zones, 230V transformator incl. (chauffer/refroidir avec contact circulateur)

Regelklemmleiste Plus 6-Zonen, Basic, 230V incl Transformator. (Heizung/Kühlung mit Pumpensteuerung)

Article number	Packing	Type
CU-6ZONEP-230V	1 pc.	

### Type: CU-DINRAIL



Din rail

Din rail

Din rail

Befestigungsschiene für Regelklemmleiste

Article number	Packing	Type
CU-DINRAIL	1 pc.	

### Type: CU-6ZONEK-24V



Base module Comfort 6 zones, 24V transformator (heating/cooling with pump contact and boiler contact)

Basismodule Comfort 6 zones, 24V met transformator incl. (verwarmen/koelen met pompsturing en ketelsturing)

Module de base Comfort 6 zones, 24V transformateur incl. (chauffer/refroidir avec contact circulateur et contact boiler))

Regelklemmleiste 6-Zonen, Komfort, 24V incl Transformator (Heizung/Kühlung mit Pumpensteuerung und Boilersteuerung)

Article number	Packing	Type
CU-6ZONEK-24V	1 pc.	

### Type: CU-6ZONEK-230V



Base module Comfort 6 zones, 230V transformator (heating/cooling with pump contact and boiler contact)

Basismodule Comfort 6 zones, 230V met transformator incl. (verwarmen/koelen met pompsturing en ketelsturing)

Module de base Comfort 6 zones, 230V transformateur incl. (chauffer/refroidir avec contact circulateur et contact boiler))

Regelklemmleiste 6-Zonen, Komfort, 230V incl Transformator (Heizung/Kühlung mit Pumpensteuerung und Boilersteuerung)

Article number	Packing	Type
CU-6ZONEK-230V	1 pc.	



### Type: CU-10ZONEK-24V



Base module Comfort 10 zones, 24V transformator (heating/cooling with pump contact and boiler contact)

Basismodule Comfort 10 zones, 24V met transformator incl. (verwarmen/koelen met pompsturing en ketelsturing)

Module de base Comfort 10 zones, 24V transformateur incl. (chauffer/refroidir avec contact circulateur et contact boiler)

Regelklemmleiste 10-Zonen, Komfort, 24V incl Transformator (Heizung/Kühlung mit Pumpensteuerung und Boilersteuerung)

Article number	Packing	Type
CU-10ZONEK-24V	1 pc.	

### Type: CU-10ZONEK-230V



Base module Comfort 10 zones, 230V transformator (heating/cooling with pump contact and boiler contact)

Basismodule Comfort 10 zones, 230V met transformator incl. (verwarmen/koelen met pompsturing en ketelsturing)

Module de base Comfort 10 zones, 230V transformateur incl. (chauffer/refroidir avec contact circulateur et contact boiler)

Regelklemmleiste 10-Zonen, Komfort, 230V incl Transformator (Heizung/Kühlung mit Pumpensteuerung und Boilersteuerung)

Article number	Packing	Type
CU-10ZONEK-230V	1 pc.	

### Type: CU-DINRAIL



Din rail

Din rail

Din rail

Befestigungsschiene für Regelklemmleiste

Article number	Packing	Type
CU-DINRAIL	1 pc.	

### Type: CU-REGB



Analog thermostat

Regelaar analog

Thermostat analogue

Raumthermostat, analog

Article number	Packing	Type
CU-REGB-24V	1 pc.	24V
CU-REGB-230V	1 pc.	230V

## C. CONTROL UNITS

### Type: CU-REGB-HC



Analog thermostat, heating/cooling  
 Regelaar analoog, verwarmen/koelen  
 Thermostat analogue, chauffer et refroidir  
 Raumthermostat, analog, heizen und kühlen

Article number	Packing	Type
CU-REGB-HC24V	1 pc.	24V
CU-REGB-HC230V	1 pc.	230V

### Type: CU-REGK



LCD komfort thermostat 24V, heating/cooling  
 Regelaar LCD comfort, 24V, verwarmen/koelen  
 LCD komfort thermostat 24V, chauffer et refroidir  
 Raumthermostat, LCD 24V, heizen und kühlen

Article number	Packing	Type
CU-REGK-24V	1 pc.	24V
CU-REGK-230V	1 pc.	230V

### Type: CU-REGC



LCD control thermostat 230V, heating/cooling + clock program  
 Regelaar LCD control, 230V, verwarmen/koelen + klokfunctie  
 LCD control thermostat 230v, chauffer et refroidir + programmation  
 Raumthermostat, LCD, Control, 230V, heizen und kühlen + Zeitsangabe

Article number	Packing	Type
CU-REGC-24V	1 pc.	24V
CU-REGC-230V	1 pc.	230V

### Type: CU-ACT



Act with cable 1m  
 Act met vaste kabel 1m  
 Act avec cable 1m  
 Stellantrieb Kabel 1m

Article number	Packing	Type
CU-ACT-24V	1 pc.	24V
CU-ACT-230V	1 pc.	230V



### Type: CU-ACT-PLUG



Act for plugcable  
Act voor steekbare kabel  
Act pour plugcable  
Sellantrieb für Stecker

Article number	Packing	Type
CU-ACT-24V-PLUG	1 pc.	24V
CU-ACT-230V-PLUG	1 pc.	230V

### Type: CU-PLUGCABLE



Act plugcable  
Losse kabel voor act  
Act plugcable  
Stecker Leitung

Article number	Packing	Type
CU-PLUGCABLE-2M	1 pc.	2 m
CU-PLUGCABLE-5M	1 pc.	5 m
CU-PLUGCABLE-15M	1 pc.	15 m

1

2

3

4

5

6

7

8

9

10

11



## C. CONTROL UNITS

- 1 **WIRELESS CONTROL UNIT (HEATING / COOLING)**
- 2 **DRAADLOZE ZONEREGELING (VERWARMEN / KOELEN)**
- 3 **RÉGULATEURS DE ZONE SANS FIL (CHAUFFAGE / REFROIDISSEMENT)**
- 4 **REGELVERTEILER FUNK (HEIZEN / KÜHLEN)**
- 5
- 6
- 7
- 8
- 9
- 10
- 11



## C. CONTROL UNITS



### Type: CU-MONO-RF



One zone module 230V  
 Module 1 zone 230V  
 Module zone individuelle 230V  
 Regelklemmleiste 1-Zone, 230V

Article number	Packing	Type
CU-MONO-RF	1 pc.	

### Type: CU-8ZONE-RF



Base module 8 zones, 230V LAN DIN rail incl. (heating/cooling)  
 Basismodule 8 zones, 230V met LAN en DIN rail (verwarmen/koelen)  
 Module de base 8 zones, 230V LAN + DIN rail incl. (chauffer/refroidir)  
 Regelklemmleiste 8-Zonen, Funk 230V incl. Befestigungsschiene (heizen und kühlen)

Article number	Packing	Type
CU-8ZONE-RF	1 pc.	

### Type: CU-8ZONEB-RF



Base module 8 zones, 230V DIN rail incl. (heating/cooling)  
 Basismodule 8 zones, 230V inclusief DIN rail (verwarmen/koelen)  
 Module de base 8 zones, 230V DIN rail incl. (chauffer/refroidir)  
 Regelklemmleiste 8-Zonen, incl. Befestigungsschiene (heizen und kühlen)

Article number	Packing	Type
CU-8ZONEB-RF	1 pc.	

### Type: CU-12ZONE-RF



Base module 12 zones, 230V LAN din rail incl. (heating/cooling)  
 Basismodule 12 zones, 230V met LAN en DIN rail (verwarmen/koelen)  
 Module de base 12 zones, 230V LAN + DIN rail incl. (chauffer/refroidir)  
 Regelklemmleiste 12-Zonen, Funk 230V incl. Befestigungsschiene (heizen und kühlen)

Article number	Packing	Type
CU-12ZONE-RF	1 pc.	

### Type: CU-REGB-RF



Analog thermostat, 0-5 incl. batt (heating/cooling)  
 Regelaar analog, met instelling 0-5 incl. batt. (verwarmen/koelen)  
 Thermostat analogue, 0-5 incl. batt (chauffer/refroidir)  
 Raumthermostat analog Funk incl. Batterie (heizen und kühlen)

Article number	Packing	Type
CU-REGB-RF	1 pc.	

- 1
- 2
- 3
- 4
- 5
- 6
- 7
- 8
- 9
- 10
- 11

## C. CONTROL UNITS

### Type: CU-REGC-RF



Thermostat LCD, optional ext. sensor  
 Regelaar LCD, met aansl. voor ext. sensor  
 thermostat LCD, option ext. sens  
 Raumthermostat LCD Funk, optional mit externem Sensor

Article number	Packing	Type
CU-REGC-RF	1 pc.	

### Type: CU-REGS-RF



Tamper free sensor  
 Ruimte sensor zonder instelling  
 Sonde sans bouton  
 Raumthermostat 24V, Behördenmodell

Article number	Packing	Type
CU-REGS-RF	1 pc.	

### Type: CU-REPEAT



Repeater  
 Repeater  
 Repeater  
 Repeater

Article number	Packing	Type
CU-REPEAT	1 pc.	

### Type: CU-ANT



Antenne  
 Antenne  
 Antenne  
 Antenne

Article number	Packing	Type
CU-ANT	1 pc.	

### Type: CU-SENS



External sensor  
 Externe sensor  
 Sonde externe  
 Externer Sensor

Article number	Packing	Type
CU-SENS	1 pc.	3 m



## C. CONTROL UNITS



### Type: CU-ACT-230V-PLUG



Act for plugcable, 230V  
Act voor steekbare kabel, 230V  
Act pour plugcable, 230V  
Stellantrieb für Stecker, 230V

Article number	Packing	Type
CU-ACT-230V-PLUG	1 pc.	

### Type: CU-PLUGCABLE



Act plugcable  
Losse kabel voor act  
Act plugcable  
Stecker Leitung

Article number	Packing	Type
CU-PLUGCABLE-2M	1 pc.	2 m
CU-PLUGCABLE-5M	1 pc.	5 m
CU-PLUGCABLE-15M	1 pc.	15 m

### Type: UFH-H5004



Copper shroud for UFH-SENSOR  
Koperen huls voor UFH-SENSOR  
Doigt de gant pour UFH-SENSOR  
Kupferhülse für UFH-SENSOR

Article number	Packing	Type
UFH-H5004	1 pc.	50 mm x 1/2"

### Type: UFH-ANC



Valve  
Zoneventiel  
Vanne  
Ventil

Article number	Packing	Type
UFH-ANC-05	1 pc.	2 x 3/4" - M30x1,5 - Kv 2
UFH-ANC-06	1 pc.	2 x 1" - M30x1,5 - Kv 4,5



## D. GEOTHERMAL

### Type: UFH-CDGEO



Manifold composite GEO, adjustable with flowmeter  
 Composiet verdeler GEO, regelbaar met debietmeting  
 Collecteur composite GEO, réglable avec débitmètre  
 Verteiler Composite GEO, regelbar mit Durchflussmengenmesser

Article number	Packing	Type
UFH-0626CD01	1 pc.	1" - 1 x Ø26
UFH-0626CD03	1 pc.	1" - 3 x Ø26
UFH-0626CD04	1 pc.	1" - 4 x Ø26
UFH-0626CD05	1 pc.	1" - 5 x Ø26
UFH-0626CD06	1 pc.	1" - 6 x Ø26
UFH-0626CD07	1 pc.	1" - 7 x Ø26

*TILL EXHAUSTION OF STOCK*

- 1
- 2
- 3
- 4
- 5
- 6
- 7
- 8
- 9
- 10
- 11



- 1
- 2
- 3
- 4
- 5
- 6
- 7
- 8
- 9
- 10
- 11

**Type: UFH-CAB-I**



**Recessed manifold cabinet, RAL 9016**  
**Verdelerkast voor inbouw, RAL 9016**  
**Boîte à encastrer pour collecteurs, RAL 9016**  
**Verteilerschrank Unterputz, RAL 9016**

Article number	Packing	Type
UFH-CAB-I400 *	1 pc.	400x700-800x112-152mm (4 circ.)
UFH-CAB-I600 *	1 pc.	600x700-800x112-152mm (8 circ.)
UFH-CAB-I800 *	1 pc.	800x700-800x112-152mm (12 circ.)
UFH-CAB-I1000 *	1 pc.	1000x700-800x112-152mm (16 circ.)

*\* Only in combination with brass manifolds*

**Type: UFH-CAB-O**



**Surface mount manifold cabinet, RAL 9016**  
**Verdelerkast voor opbouw, RAL 9016**  
**Boîte à poser pour collecteurs, RAL 9016**  
**Verteilerschrank Aufputz, RAL 9016**

Article number	Packing	Type
UFH-CAB-O400 *	1 pc.	400x720x112mm (4 circ.)
UFH-CAB-O600 *	1 pc.	600x720x112mm (8 circ.)
UFH-CAB-O800 *	1 pc.	800x720x112mm (12 circ.)
UFH-CAB-O1000 *	1 pc.	1000x720x112mm (16 circ.)

*\* Only in combination with brass manifolds*



Press machines, press jaws and calibrating tools should be checked on a regular base when used intensively.

Persmachines, persbekken en kalibreergereedschap dienen bij intensief gebruik op regelmatige basis gecontroleerd te worden.

Des machines à sertir, des pinces et des outils pour calibrage soumis à un usage intensif doivent être contrôlé régulièrement.

Press Maschinen, Pressbacken und Kalibrierung Werkzeuge sollten auf einer regelmäßigen Basis überprüft werden, wenn intensiv genutzt.



## Type: BI



**Internal bending spring**  
**Binnenbuigveer**  
**Ressort à plier intérieur**  
**Biegefeder innen**

Article number	pc / Box	Type
BI-1410	1 pc. / 100 pc.	14x2 L=50 cm
BI-1612	1 pc. / 100 pc.	16x2 L=50 cm
BI-1612L	1 pc. / 50 pc.	16x2 L=100 cm
BI-1814	1 pc. / 75 pc.	18x2 L=50 cm
BI-2016	1 pc. / 75 pc.	20x2 L=50 cm
BI-2016L	1 pc. / 25 pc.	20x2 L=100 cm
BI-2620	1 pc. / 25 pc.	26x3 L=100 cm

## Type: BA



**External bending spring**  
**Buitenbuigveer**  
**Ressort à plier extérieur**  
**Biegefeder aussen**

Article number	pc / Box	Type
BA-1288	1 pc. / 50 pc.	12x1,88 L=50 cm
BA-1410	1 pc. / 50 pc.	14x2 L=50 cm
BA-1612	1 pc. / 50 pc.	16x2 L=50 cm
BA-1814	1 pc. / 50 pc.	18x2 L=50 cm
BA-2016	1 pc. / 50 pc.	20x2 L=50 cm

## Type: BM



**Bending tool**  
**Buigijzer**  
**Cintreuse**  
**Biegewerkzeug**

Article number	Packing	Type
BM-16	1 pc.	for Ø16
BM-18	1 pc.	for Ø18
BM-20	1 pc.	for Ø20
BM-26	1 pc.	for Ø26

## Type: RSPRESS



**Guillotine cutter**  
**Guillotineschaar**  
**Pince guillotine**  
**Guillotinezange**

Article number	Packing	Type
RS1420PRESS	1 pc.	14 till 20 mm
RS2640PRESS	1 pc.	26 till 40 mm



### Type: RSEM-PERS



Replacement blade for art. RS1420PRESS and RS2640PRESS

Vervangmes voor art. RS1420PRESS en RS2640PRESS

Lame pour art. RS1420PRESS et RS2640PRESS

Ersatzmesser für Art. RS1420PRESS UND RS2640PRESS

Article number	Packing	Type
RSEM1420-PERS	1 pc.	14 till 20 mm
RSEM2640-PERS	1 pc.	26 till 40 mm

### Type: RSPRESS-N



Guillotine cutter

Guillotineschaar

Pince guillotine

Guillotinezange

Article number	Packing	Type
RS1420PRESS-N	1 pc.	14 till 20 mm

### Type: RS



Wheel cutter

Buizensnijder

Coupe-tube

Rohrschneidezange

Article number	Packing	Type
RS32	1 pc.	14 till 32 mm
RS63	1 pc.	14 till 63 mm

### Type: RSEM



Replacement wheel for art. RS32 and RS63

Vervangmes voor art. RS32 en RS63

Lame de rechange pour art. RS32 et RS63

Ersatzmesser für Art. RS32 und RS63

Article number	Packing	Type
RSEM32	1 pc.	14 till 32 mm
RSEM63	1 pc.	14 till 63 mm

- 1
- 2
- 3
- 4
- 5
- 6
- 7
- 8
- 9
- 10
- 11



### Type: SAFECUT



Cutter to open the packing paper  
 Mes om verpakkingspapier te openen  
 Couteau pour ouvrir le papier d'emballage  
 Schneider zum Öffnen der Packing

Article number	Packing	Type
SAFECUT	1 pc.	SAFECUT

### Type: PS-16



Pipe straightener Ø16  
 Buizenrechter Ø16  
 Redresseur Ø16  
 Rohrbegradiger Ø16

Article number	Packing	Type
PS-16	1 pc.	PS

### Characteristics PS-16

- ▶ Simplifies installation and reduces labour
- ▶ Easy to use
- ▶ Less material usage and waste
- ▶ Accelerated flow for better efficiencies and reduced running costs
- ▶ Professional looking finish

### Type: KS-MSET1



Set with KS-K and KS-M for Ø16, 20 and 26  
 Set met KS-K en KS-M voor Ø16, 20 en 26  
 Set avec KS-K et KS-M pour Ø16, 20 et 26  
 Set mit KS-K und KS-M für Ø16, 20 und 26

Article number	Packing	Type
KS-MSET1	1 pc.	MSET1

### Type: KS-MSET4



Set with KS-K and KS-M for Ø16, 20, 26 and 32  
 Set met KS-K en KS-M voor Ø16, 20, 26 en 32  
 Set avec KS-K et KS-M pour Ø16, 20, 26 et 32  
 Set mit KS-K und KS-M für Ø16, 20, 26 und 32

Article number	Packing	Type
KS-MSET4	1 pc.	MSET4





### Type: KS



Kalispeed for electric drills (max. 500 rpm, clockwise only)  
 Kalispeed voor accu-boormachine (max. 500 toeren, rechts draaien verplicht)  
 Kalispeed pour perceuses à batterie (max. 500 tournages, obligation de tourner à droite)  
 Kalispeed für Akku-Bohrmaschine (max. 500 Drehungen, rechts drehen verpflichtet)

Article number	Packing	Type
KS50	1 pc.	for Ø50
KS63	1 pc.	for Ø63

### Type: KS-M



Kalispeed, metal, for KS-K and electric drills (max. 500 rpm, clockwise only)  
 Kalispeed, metaal, voor KS-K en accu-boormachine (max. 500 toeren, rechts draaien verplicht)  
 Kalispeed, métal, pour KS-K et perceuses à batterie (max. 500 tours, obligation de tourner à droite)  
 Kalispeed, Metall, für KS-K und Akku-Bohrmaschine (max. 500 Drehungen, rechts drehen verpflichtet)

Article number	Packing	Type
KS12M	1 pc.	for Ø12
KS14M	1 pc.	for Ø14
KS16M	1 pc.	for Ø16
KS18M	1 pc.	for Ø18
KS20M	1 pc.	for Ø20
KS26M	1 pc.	for Ø26
KS32M	1 pc.	for Ø32
KS40M	1 pc.	for Ø40

### Type: KS-K



Clickhandle for KS (Kalispeed)  
 Klikhandvat voor KS (Kalispeed)  
 Manche clic pour KS (Kalispeed)  
 Klickgriff für KS (Kalispeed)

Article number	Packing	Type
KS-K	1 pc.	up to Ø26 mm

### Type: KS-P



Kalispeed for Ø16, 20 and 26  
 Kalispeed voor Ø16, 20 en 26  
 Kalispeed pour Ø16, 20 et 26  
 Kalispeed für Ø16, 20 und 26

Article number	Packing	Type
KS-P162026	1 pc.	for Ø16, 20 and 26

*Not for intensive use*

- 1
- 2
- 3
- 4
- 5
- 6
- 7
- 8
- 9
- 10
- 11



### Type: PH-1632



Pipe holder for diameters 16-20-26-32  
 Griptang voor buis diameter 16-20-26-32  
 Pince de maintien diamètre 16-20-26-32  
 Rohrhalter für Diameter 16-20-26-32

Article number	Packing	Type
PH-1632	1 pc.	up to 32 mm

### Characteristics PH-1632

- ▶ Always sufficient grip when calibrating short pipe ends
- ▶ Prevents the pipe from turning too during calibration
- ▶ Inspired by the classic nutcracker model
- ▶ Henco blue anodised aluminium
- ▶ Lightweight tool
- ▶ Suitable for pipe diameters of 16 –20 –26 –32



### Type: M-BA03



Kit: battery press machine including battery + charge unit + case, linear drive 32 kN, up to Ø 63  
 Kit: accu-persmachine + accu + lader + koffer, lineaire aandrijving 32 kN, tot Ø 63  
 Kit: machine à sertir + batterie + chargeur + coffret, propulsion linéaire 32 kN, jusqu'à Ø 63  
 Kit: Akku-Pressmaschine, lineare Schubkraft 32 kN, bis Ø 63

Article number	Packing	Type
M-BA03	1 pc.	BA03

### Type: M-BAT03



Battery for M-BA03  
 Accu voor M-BA03  
 Batterie pour M-BA03  
 Akku für M-BA03

Article number	Packing	Type
M-BAT03	1 pc.	BAT03

### Type: M-LAD03



Charge-unit for M-BA03, M-BMINI2  
Lader voor M-BA03, M-BMINI2  
Chargeur pour M-BA03, M-BMINI2  
Akku-Ladegerät für M-BA03, M-BMINI2

Article number	Packing	Type
M-LAD03	1 pc.	LAD03

### Type: M-TRANS03



Mains Adapter for M-BA03  
Adapter voor netaansluiting voor M-BA03  
Adaptateur raccordement au réseau pour M-BA03  
Netzadapter für M-BA03I

Article number	Packing	Type
M-TRANS03	1 pc.	TRANS03

### Type: M-BOXBA03



Case for M-BA03  
Koffer voor M-BA03  
Coffret pour M-BA03  
Koffer für M-BA03

Article number	Packing	Type
M-BOXBA03	1 pc.	CASE M-BA03

- 1
- 2
- 3
- 4
- 5
- 6
- 7
- 8
- 9
- 10
- 11



- 1
- 2
- 3
- 4
- 5
- 6
- 7
- 8
- 9
- 10
- 11

**Type: M-BHY162026**



Kit : 230 volt hydraulic press machine with 16, 20, 26 jaws + metal case (110 volt also available), linear drive 32 to 40 kN  
 Kit : Elektrisch-hydraulische persmachine + bekken 16, 20, 26 + koffer, liniaire aandrijving 32 tot 40kN  
 Kit: machine à sertir électro-hydraulique + pinces 16, 20, 26 + coffret, propulsion linéaire 32 jusqu'à 40 kN  
 Kit : Elektrohydraulische Pressmaschine + Pressbacken 16, 20, 26 + Koffer, lineare Schubkraft 32 bis 40 kN

Article number	Packing	Type
M-BHY162026	1 pc.	Ø14-63

**Type: M-BHY**



Kit : 230 volt hydraulic press machine + metal case (110 volt also available), linear drive 32 to 40 kN  
 Kit : Elektrisch-hydraulische persmachine + koffer, liniaire aandrijving 32 tot 40kN  
 Kit: machine à sertir électro-hydraulique + coffret, propulsion linéaire 32 jusqu'à 40 kN  
 Kit : Elektrohydraulische Pressmaschine + Koffer, lineare Schubkraft 32 bis 40 kN

Article number	Packing	Type
M-BHY	1 pc.	Ø14-63

**Type: M-BOXBHY**



Metal case for M-BHY162026  
 Koffer voor M-BHY162026  
 Coffret en métal pour M-BHY162026  
 Koffer für M-BHY162026

Article number	Packing	Type
M-BOXBHY	1 pc.	Ø14-63



## Type: BE



Jaws (universal)  
 Persbekken (universeel)  
 Pincen à sertir (universel)  
 Pressbacken (universal)

Article number	Packing	Type
BE14	1 pc.	BE/TH 14x2
BE16	1 pc.	BE/TH 16x2
BE18	1 pc.	BE/TH 18x2
BE20	1 pc.	BE/TH 20x2
BE26	1 pc.	BE/TH 26x3
BE32	1 pc.	BE 32x3
BE40	1 pc.	BE 40x3,5
BE50	1 pc.	BE 50x4
BE63	1 pc.	BE 63x4,5

## Type: BE-UNISSET1



Set with universal jaw mounting unit and BE-H inserts Ø16, 20 and 26  
 Set met universele moederbekken en wisselbekken BE-H Ø16, 20, 26  
 Set avec pince mère universel et pinces BE-H Ø16, 20, 26  
 Set mit Mutterpressbacke universal und Backen BE-H Ø16, 20, 26

Article number	Packing	Type
BE-UNISSET1	1 pc.	UNISSET1

*Press tool compatibility: see technical manual*

## Type: BE-UNISSET2



Set with universal jaw mounting unit and BE-H inserts Ø14, 16, 18, 20, 26, and 32  
 Set met universele moederbek en wisselbekken BE-H Ø14, 16, 18, 20, 26 en 32  
 Set avec pince mère universel et pinces BE-H Ø14, 16, 18, 20, 26, et 32  
 Set mit Mutterpressbacke universal und Backen BE-H Ø14, 16, 18, 20, 26, und 32

Article number	Packing	Type
BE-UNISSET2	1 pc.	UNISSET2

*Press tool compatibility: see technical manual*

1

2

3

4

5

6

7

8

9

10

11



### Type: TOOLBOX16202632



Box with KS16 20 26 32 M, BE-UNI, BE16 20 26 32 H, BI-1612, BI-2016, BA-1612, BA-2016, RS1420PRESS, SAFECUT  
 Koffer met KS16 20 26 32 M, BE-UNI, BE16 20 26 32 H, BI-1612, BI-2016, BA-1612, BA-2016, RS1420PRESS, SAFECUT  
 Coffre avec KS16 20 26 32 M, BE-UNI, BE16 20 26 32 H, BI-1612, BI-2016, BA-1612, BA-2016, RS1420PRESS, SAFECUT  
 Koffer mit KS16 20 26 32 M, BE-UNI, BE16 20 26 32 H, BI-1612, BI-2016, BA-1612, BA-2016, RS1420PRESS, SAFECUT

Article number	Packing	Type
TOOLBOX16202632	1 pc.	TOOLBOX16202632

### Type: TOOLBOX405063



Box with KS40M, KS50, KS63, BE40 50 63, RS63  
 Koffer met KS40M, KS50, KS63, BE40 50 63, RS63  
 Coffre avec KS40M, KS50, KS63, BE40 50 63, RS63  
 Koffer mit KS40M, KS50, KS63, BE40 50 63, RS63

Article number	Packing	Type
TOOLBOX405063	1 pc.	TOOLBOX405063

### Type: BE-UNI



Jaw mounting unit for M-BA03 and M-BHY, to be used with BE-H jaws  
 Moederbek voor M-BA03 en M-BHY en te gebruiken met BE-H bekken  
 Pince mère pour M-BA03 et M-BHY, à utiliser avec pinces BE-H  
 Mutterpressbacke für M-BA003 und M-BHY, zu verwenden mit BE-H Backen

Article number	Packing	Type
BE-UNI	1 pc.	BE-UNI

*Press tool compatibility: see technical manual*

*BE-UNI is designed to press Henco press fittings, the interchangeable dies with M- and V-profile make it possible to make the transition from other materials to Henco; other than Henco branded fittings with compact measurements can cause complex manipulation.*



## Type: BE-H



Inserts for BE-UNI, BE-MINI2, BE-MINI3, M-BH  
 Wisselbekken voor BE-UNI, BE-MINI2, BE-MINI3, M-BH  
 Pincés pour BE-UNI, BE-MINI2, BE-MINI3, M-BH  
 Pressbacken für BE-UNI, BE-MINI2, BE-MINI3, M-BH

Article number	Packing	Type
BE14H	1 Set (2 pc.)	BE/TH 14X2 H
BE16H	1 Set (2 pc.)	BE/TH 16X2 H
BE18H	1 Set (2 pc.)	BE/TH 18X2 H
BE20H	1 Set (2 pc.)	BE/TH 20X2 H
BE26H	1 Set (2 pc.)	BE/TH 26X3 H
BE32H	1 Set (2 pc.)	BE 32X3 H

## Type: BE-HC



Inserts (copper) for BE-UNI, BE-MINI2, M-BH, BE-MINI3  
 Wisselbekken (koper) voor BE-UNI, BE-MINI2, M-BH, BE-MINI3  
 Pincés (cuivre) pour BE-UNI, BE-MINI2, M-BH, BE-MINI3  
 Pressbacken (Kupfer) für BE-UNI, BE-MINI2, M-BH, BE-MINI3

Article number	Packing	Type
BE12HC	1 Set (2 pc.)	12Cu V-profile
BE14HC	1 Set (2 pc.)	14Cu V-profile
BE15HC	1 Set (2 pc.)	15Cu V-profile
BE16HC	1 Set (2 pc.)	16Cu V-profile
BE18HC	1 Set (2 pc.)	18Cu V-profile
BE22HC	1 Set (2 pc.)	22Cu V-profile
BE28HC	1 Set (2 pc.)	28Cu V-profile

## Type: BE-HM



Inserts (copper) for BE-UNI, BE-MINI2, M-BH, BE-MINI3  
 Wisselbekken (koper) voor BE-UNI, BE-MINI2, M-BH, BE-MINI3  
 Pincés (cuivre) pour BE-UNI, BE-MINI2, M-BH, BE-MINI3  
 Pressbacken (Kupfer) für BE-UNI, BE-MINI2, M-BH, BE-MINI3

Article number	Packing	Type
BE12HM	1 Set (2 pc.)	12Cu M-profile
BE15HM	1 Set (2 pc.)	15Cu M-profile
BE18HM	1 Set (2 pc.)	18Cu M-profile
BE22HM	1 Set (2 pc.)	22Cu M-profile

## Type: BE-BOX



Metal case for 4 compression jaws  
 Stalen koffer voor 4 persbekken  
 Coffret en métal pour 4 pincés à sertir  
 Stahlblechkasten für 4 Pressbacken

Article number	Packing	Type
BE-BOX	1 pc.	BOX

- 1
- 2
- 3
- 4
- 5
- 6
- 7
- 8
- 9
- 10
- 11



- 1
- 2
- 3
- 4
- 5
- 6
- 7
- 8
- 9
- 10
- 11

**Type: M-BMINI3-F**



Kit : compact rechargeable battery press machine with press monitoring + case + charge unit + battery 18V + full jaws TH16-20-26, linear drive ca. 19 kN  
 Kit: hydraulische accu-persmachine met persbewaking + koffer + lader + 1 accu 18V + volle bekken TH16-20-26, lineaire aandrijving ca. 19kN  
 Kit : machine à sertir hydraulique + boîte + chargeur + batterie 18V, pince TH16-20-26, propulsion linéaire ca.19 kN  
 Kit: Hydraulisches Akku-Presswerkzeug mit Pressdrucküberwachung + Koffer + Ladegerät + 1 Akku 18V + Pressbacken TH16-20-26, lineare Schubkraft ca. 19 kN

Article number	Packing	Type
M-BMINI3-F	1 pc.	Ø16-26 / 18V

**Type: M-BMINI3**



Kit : compact rechargeable battery press machine with press monitoring + case + charge unit + battery 18V + mother jaw + inserts TH16-20-26, linear drive ca. 19 kN  
 Kit: hydraulische accu-persmachine met persbewaking + koffer + lader + 1 accu 18V + moederbek met inserts TH16-20-26, lineaire aandrijving ca. 19kN  
 Kit : machine à sertir hydraulique + boîte + chargeur + batterie 18V + pince mère + inserts TH16-20-26, propulsion linéaire ca.19 kN  
 Kit: Hydraulisches Akku-Presswerkzeug mit Pressdrucküberwachung + Koffer + Ladegerät + 1 Akku 18V + Mutterpressbacke und Pressbacken TH16-20-26, lineare Schubkraft ca. 19 kN

Article number	Packing	Type
M-BMINI3	1 pc.	Ø16-26 / 18V

**Type: M-BMINI3-S**



Kit : compact rechargeable battery press machine with press monitoring + case + charge unit + battery 18V, linear drive ca. 19 kN  
 Kit: hydraulische accu-persmachine met persbewaking + koffer + lader + 1 accu 18V, lineaire aandrijving ca. 19kN  
 Kit : machine à sertir hydraulique + boîte + chargeur + batterie 18V, propulsion linéaire ca.19 kN  
 Kit: Hydraulisches Akku-Presswerkzeug mit Pressdrucküberwachung + Koffer + Ladegerät + 1 Akku 18V, lineare Schubkraft ca. 19 kN

Article number	Packing	Type
M-BMINI3-S	1 pc.	Ø16-26 / 18V



### Type: M-BATMINI3



Battery 18V for M-BMINI3-F, M-BMINI3, M-BMINI3-S  
Accu 18V voor M-BMINI3-F, M-BMINI3, M-BMINI3-S  
Batterie 18V pour M-BMINI3-F, M-BMINI3, M-BMINI3-S  
Akku 18V für M-BMINI3-F, M-BMINI3, M-BMINI3-S

Article number	Packing	Type
M-BATMINI3-1.5AH	1 pc.	18V / 1,5 Ah Li-ion
M-BATMINI3-3.0AH	1 pc.	18V / 3,0 Ah Li-ion

### Type: M-LADMINI3



Charge-unit for M-BMINI3-F, M-BMINI3, M-BMINI3-S  
Lader voor M-BMINI3-F, M-BMINI3, M-BMINI3-S  
Chargeur pour M-BMINI3-F, M-BMINI3, M-BMINI3-S  
Akku-Ladegerät für M-BMINI3-F, M-BMINI3, M-BMINI3-S

Article number	Packing	Type
M-LADMINI3	1 pc.	for M-BATMINI3

### Type: M-TRANSMINI3



Mains Adapter for M-BMINI3-F, M-BMINI3, M-BMINI3-S + 5m cable  
Adapter voor netaansluiting M-BMINI3-F, M-BMINI3, M-BMINI3-S + 5m kabel  
Adaptateur raccordement au réseau M-BMINI3-F, M-BMINI3, M-BMINI3-S + 5m cable  
Netzadapter für M-BMINI3-F, M-BMINI3, M-BMINI3-S + 5m Kabel

Article number	Packing	Type
M-TRANSMINI3	1 pc.	18V / 230V

### Type: M-BOXMINI3



Metal case for M-BMINI3, M-BMINI3-S  
Koffer in metaal voor M-BMINI3, M-BMINI3-S  
Coffret en métal pour M-BMINI3, M-BMINI3-S  
Koffer in Metal für M-BMINI3, M-BMINI3-S

Article number	Packing	Type
M-BOXMINI3	1 pc.	M-BOXMINI3



### Type: M-BOXMINI3-F



Metal case for M-BMINI3-F  
 Koffer in metaal voor M-BMINI3-F  
 Coffret en métal pour M-BMINI3-F  
 Koffer in Metal für M-BMINI3-F

Article number	Packing	Type
M-BOXMINI3-F	1 pc.	M-BOXMINI3-F

### Type: BE-MINI3



Mother jaw press machine M-BMINI3 with BE-H inserts  
 Moederbek voor persmachine M-BMINI3 met BE-H inserts  
 Pince mère pour machine à sertir M-BMINI3 avec pinces BE-H  
 Mutterpressbacke für Presswerkzeuge M-BMINI3, zu verwenden mit BE-H backen

Article number	Packing	Type
BE-MINI3	1 pc.	BE-MINI3

### Type: BE..-MINI3



Jaw for press machine M-BMINI3 - TH profile  
 Bek voor persmachine M-BMINI3 - TH profiel  
 Pince pour machine à sertir M-BMINI3 - Profil TH  
 Pressbacke für Presswerkzeuge M-BMINI3 + Profil TH

Article number	Packing	Type
BE14MINI3	1 pc.	BE/TH Ø14
BE16MINI3	1 pc.	BE/TH Ø16
BE20MINI3	1 pc.	BE/TH Ø20
BE26MINI3	1 pc.	BE/TH Ø26
BE32MINI3	1 pc.	BE Ø32

### Type: BE.V-MINI3



Jaw for press machine M-BMINI3 - V profile  
 Bek voor persmachine M-BMINI3 - V profiel  
 Pince pour machine à sertir M-BMINI3 - Profil V  
 Pressbacke für Presswerkzeuge M-BMINI3 + Profil V

Article number	Packing	Type
BE15V-MINI3	1 pc.	V-profile 15mm
BE18V-MINI3	1 pc.	V-profile 18mm
BE22V-MINI3	1 pc.	V-profile 22mm
BE28V-MINI3	1 pc.	V-profile 28mm



### Type: BE.M-MINI3



Jaw for press machine M-BMINI3 - M profile  
 Bek voor persmachine M-BMINI3 - M profiel  
 Pince pour machine à sertir M-BMINI3 - Profil M  
 Pressbacke für Presswerkzeuge M-BMINI3 + Profil M

Article number	Packing	Type
BE12M-MINI3	1 pc	M-profile 15mm
BE15M-MINI3	1 pc.	M-profile 15mm
BE18M-MINI3	1 pc.	M-profile 18mm
BE22M-MINI3	1 pc.	M-profile 22mm
BE28M-MINI3	1 pc.	M-profile 28mm

### Type: M-BMINI2-SLB



Kit : compact rechargeable battery press machine with press monitoring + case, linear drive ca. 15 kN  
 Kit: hydraulische accu-persmachine met persbewaking + kunststofkoffer, lineaire aandrijving ca. 15kN  
 Kit : machine à sertir hydraulique + boîte en plastique, propulsion linéaire ca.15 kN  
 Kit: Hydraulisches Akku-Presswerkzeug mit Pressdrucküberwachung + Kunststoffkoffer, lineare Schubkraft ca. 15 kN

Article number	Packing	Type
M-BMINI2-SLB	1 pc.	Ø14-32, 18V / 1,5 Ah Li-ion

### Type: M-BATMINI2



Battery 18V / 1,5 Ah Li-ion for M-BMINI2  
 Accu 18V / 1,5 Ah Li-ion voor M-BMINI2  
 Batterie 18V / 1,5 Ah Li-ion pour M-BMINI2  
 Akku 18V / 1,5 Ah Li-ion für M-BMINI2

Article number	Packing	Typ
M-BATMINI2	1 pc.	18V / 1,5 Ah Li-ion

### Type: M-TRANSMINI2



Mains Adapter for M-BMINI2(S)  
 Adapter voor netaansluiting M-BMINI2(-S)  
 Adapteur raccordement au réseau M-BMINI2(-S)  
 Netzadapter für M-BMINI2(-S)

Article number	Packing	Type
M-TRANSMINI2	1 pc.	18V / 230V

- 1
- 2
- 3
- 4
- 5
- 6
- 7
- 8
- 9
- 10
- 11



- 1
- 2
- 3
- 4
- 5
- 6
- 7
- 8
- 9
- 10
- 11

**Type: M-BOXMINI2**



Case for M-BMINI2(-S)  
 Koffer voor M-BMINI2(-S)  
 Coffret pour M-BMINI2(-S)  
 Koffer für M-BMINI2(-S)

Article number	Packing	Type
M-BOXMINI2	1 pc.	M-BOXMINI2

**Type: BE..-MINI**



Jaw for press machine M-BMINI2(-S) and M-HP32  
 Bek voor persmachine M-BMINI2(-S) en M-HP32  
 Pince pour machine à sertir M-BMINI2(-S) et M-HP32  
 Pressbacke für Presswerkzeuge M-BMINI2(-S) und M-HP32

Article number	Packing	Type
BE16MINI	1 pc.	BE/TH Ø16
BE20MINI	1 pc.	BE/TH Ø20
BE26MINI	1 pc.	BE/TH Ø26
BE32MINI	1 pc.	BE Ø32

**Type: BE..-MMINI**



M-profile jaw (copper) for press machine M-BMINI2(-S) and M-HP32  
 M-profiel bek (koper) voor persmachine M-BMINI2(-S) en M-HP32  
 M-profil pincen (cuivre) pour machine à sertir M-BMINI2(-S) et M-HP32  
 M-profil Pressbacke (Kupfer) für Presswerkzeuge M-BMINI2(-S) und M-HP32

Article number	Packing	Type
BE15MMINI	1 pc.	Ø15Cu M-Profile
BE22MMINI	1 pc.	Ø22Cu M-Profile

## Type: BE-C



V-profile jaw (copper) for press machine M-BMINI2(-S) and M-HP32  
V-profiel bek (koper) voor persmachine M-BMINI2(-S) en M-HP32  
V-profil pinces (cuivre) pour machine à sertir M-BMINI2(-S) et M-HP32  
V-profil Pressbacke (Kupfer) für Presswerkzeuge M-BMINI2(-S) und M-HP32

Article number	Packing	Type
BE15C	1 pc.	Ø15Cu V-Profile
BE18C	1 pc.	Ø18Cu V-Profile
BE22C	1 pc.	Ø22Cu V-Profile
BE28C	1 pc.	Ø28Cu V-Profile

## Type: BE-MINI



Jaw mounting unit for press machine M-BMINI2(-S) / M-HP32 and to be used with BE-H jaws  
Moederbek voor persmachine M-BMINI2(-S) / M-HP32 en te gebruiken met BE-H bekken  
Pince mère pour machine à sertir M-BMINI2(-S) / M-HP32 et à utiliser avec pinces BE-H  
Mutterpressbacke für Presswerkzeug M-BMINI2(-S) / M-HP32, zu verwenden mit BE-H Backen

Article number	Packing	Type
BE-MINI	1 pc.	BE-MINI

BE-MINI is designed to press Henco press fittings, the interchangeable dies with M- and V-profile make it possible to make the transition from other materials to Henco; other than Henco branded fittings with compact measurements can cause complex manipulation

## Type: BE-H



Inserts for BE-UNI, BE-MINI2, BE-MINI3, M-BH  
Wisselbekken voor BE-UNI, BE-MINI2, BE-MINI3, M-BH  
Pinces pour BE-UNI, BE-MINI2, BE-MINI3, M-BH  
Pressbacken für BE-UNI, BE-MINI2, BE-MINI3, M-BH

Article number	Packing	Type
BE14H	1 Set (2 pc.)	BE/TH 14X2 H
BE16H	1 Set (2 pc.)	BE/TH 16X2 H
BE18H	1 Set (2 pc.)	BE/TH 18X2 H
BE20H	1 Set (2 pc.)	BE/TH 20X2 H
BE26H	1 Set (2 pc.)	BE/TH 26X3 H
BE32H	1 Set (2 pc.)	BE 32X3 H



## Type: BE-HC



Inserts (copper) for BE-UNI, BE-MINI2, M-BH, BE-MINI3  
 Wisselbekken (koper) voor BE-UNI, BE-MINI2, M-BH, BE-MINI3  
 Pincas (cuivre) pour BE-UNI, BE-MINI2, M-BH, BE-MINI3  
 Pressbacken (Kupfer) für BE-UNI, BE-MINI2, M-BH, BE-MINI3

Article number	Packing	Type
BE12HC	1 Set (2 pc.)	12Cu V-profile
BE14HC	1 Set (2 pc.)	14Cu V-profile
BE15HC	1 Set (2 pc.)	15Cu V-profile
BE16HC	1 Set (2 pc.)	16Cu V-profile
BE18HC	1 Set (2 pc.)	18Cu V-profile
BE22HC	1 Set (2 pc.)	22Cu V-profile
BE28HC	1 Set (2 pc.)	28Cu V-profile

## Type: BE-HM



Inserts (copper) for BE-UNI, BE-MINI2, M-BH, BE-MINI3  
 Wisselbekken (koper) voor BE-UNI, BE-MINI2, M-BH, BE-MINI3  
 Pincas (cuivre) pour BE-UNI, BE-MINI2, M-BH, BE-MINI3  
 Pressbacken (Kupfer) für BE-UNI, BE-MINI2, M-BH, BE-MINI3

Article number	Packing	Type
BE12HM	1 Set (2 pc.)	12Cu M-profile
BE15HM	1 Set (2 pc.)	15Cu M-profile
BE18HM	1 Set (2 pc.)	18Cu M-profile
BE22HM	1 Set (2 pc.)	22Cu M-profile

## Type: M-HP



Hydraulic manual press tool + bag  
 Hydraulisch handpersmachine + draagtas  
 Machine à sertir manuelle hydraulique + sac  
 Hydraulisches Handpressmaschine + Tasche

Article number	Packing	Type
M-HP32	1 pc.	Ø14-32

## Type: M-BH



Kit: manual press machine + inserts 16,20,26 + bag  
 Kit: handpersmachine + bken 16, 20, 26 + draagtas  
 Kit: machine à sertir manuelle + pinces 16, 20, 26 + sac  
 Kit: Handpersmaschine + Pressbacken 16, 20, 26 + Tasche

Article number	Packing	Type
M-BH162026	1 pc.	BH 16x2 / 20x2 / 26x3

## Type: BE-H



Inserts for BE-UNI, BE-MINI2, BE-MINI3, M-BH  
Wisselbekken voor BE-UNI, BE-MINI2, BE-MINI3, M-BH  
Pincas pour BE-UNI, BE-MINI2, BE-MINI3, M-BH  
Pressbacken für BE-UNI, BE-MINI2, BE-MINI3, M-BH

Article number	Packing	Type
BE14H	1 Set (2 pc.)	BE/TH 14X2 H
BE16H	1 Set (2 pc.)	BE/TH 16X2 H
BE18H	1 Set (2 pc.)	BE/TH 18X2 H
BE20H	1 Set (2 pc.)	BE/TH 20X2 H
BE26H	1 Set (2 pc.)	BE/TH 26X3 H
BE32H	1 Set (2 pc.)	BE 32X3 H

## Type: BE-HC



Inserts (copper) for BE-UNI, BE-MINI2, M-BH, BE-MINI3  
Wisselbekken (koper) voor BE-UNI, BE-MINI2, M-BH, BE-MINI3  
Pincas (cuivre) pour BE-UNI, BE-MINI2, M-BH, BE-MINI3  
Pressbacken (Kupfer) für BE-UNI, BE-MINI2, M-BH, BE-MINI3

Article number	Packing	Type
BE12HC	1 Set (2 pc.)	12Cu V-profile
BE14HC	1 Set (2 pc.)	14Cu V-profile
BE15HC	1 Set (2 pc.)	15Cu V-profile
BE16HC	1 Set (2 pc.)	16Cu V-profile
BE18HC	1 Set (2 pc.)	18Cu V-profile
BE22HC	1 Set (2 pc.)	22Cu V-profile
BE28HC	1 Set (2 pc.)	28Cu V-profile

## Type: BE-HM



Inserts (copper) for BE-UNI, BE-MINI2, M-BH, BE-MINI3  
Wisselbekken (koper) voor BE-UNI, BE-MINI2, M-BH, BE-MINI3  
Pincas (cuivre) pour BE-UNI, BE-MINI2, M-BH, BE-MINI3  
Pressbacken (Kupfer) für BE-UNI, BE-MINI2, M-BH, BE-MINI3

Article number	Packing	Type
BE12HM	1 Set (2 pc.)	12Cu M-profile
BE15HM	1 Set (2 pc.)	15Cu M-profile
BE18HM	1 Set (2 pc.)	18Cu M-profile
BE22HM	1 Set (2 pc.)	22Cu M-profile

## Type: M-BM1620



Kit: manual press machine with 16, 20 jaws  
Kit: handpersmachine + wisselbekken 16, 20  
Kit: machine à sertir manuelle + pincas 16, 20  
Kit: Handpressmaschine + Pressbacken 16, 20

Article number	Packing	Type
M-BM1620	1 pc.	BM 16x2 / 20x2



**Type: BE-M**



Inserts for M-BM1620  
Wisselbekken voor M-BM1620  
Pincés pour M-BM1620  
Pressbacken für M-BM1620

Article number	Packing	Type
BE14M	1 Set (2 pc.)	BE 14X2 M
BE16M	1 Set (2 pc.)	BE 16X2 M
BE18M	1 Set (2 pc.)	BE 18X2 M
BE20M	1 Set (2 pc.)	BE 20X2 M

**Type: PRESSCHECK**



Tool to control the accuracy of a pressing  
Instrument om correctheid v/e persing te controleren  
Outil pour contrôler la précision d'un sertissage  
Instrument zur Überprüfung ob die Pressung korrekt ausgeführt

Article number	Packing	Type
PRESSCHECK1432	1 pc.	Ø14-32

**Type: DRILLY**



Drilly temporary air vent plug, reusable  
Drilly voor afdrukken leidingssysteem, herbruikbaar  
Drilly pour tester le système de tubes, réutilisable  
Drilly zum abdrukken Rohresysteme, wieder verwendbar

Article number	Packing	Type
DRILLY14	1 pc.	Ø14
DRILLY16	1 pc.	Ø16
DRILLY18	1 pc.	Ø18
DRILLY20	1 pc.	Ø20
DRILLY26	1 pc.	Ø26
DRILLY32	1 pc.	Ø32

**Type: PLUG**



Plug  
Afdrukplug  
Bouchon  
Stopf

Article number	Packing	Type
PLUG04-B80	20 pc.	1/2" - 80 mm blue
PLUG04-R80	20 pc.	1/2" - 80 mm red
PLUG05-B80	20 pc.	3/4" - 80 mm blue
PLUG05-R80	20 pc.	3/4" - 80 mm red





### Type: UFH-VLA



Decoiler, standard model  
 Haspel, basismodel  
 Machine à dérouler, standard  
 Abwickelmaschine, Standard

Article number	Packing	Type
UFH-VLA	1 pc.	25 m - 600 m

*Minimum inner diameter coil: 140mm*

### Type: UFH-VLA-STR



Pipe straightener for decoiler UFH-VLA 14-26 mm  
 Stangenrechter voor haspel UFH-VLA 14-26 mm  
 Machine à produire des barres pour dérouleur UFH-VLA 14-26 mm  
 Stangenmaschine für Wichelmaschine UFH-VLA 14-26 mm

Article number	Packing	Type
UFH-VLA-STR	1 pc.	

### Type: UFH-VLG



Decoiler, tilting possible, on wheels  
 Haspel, kantelbaar, op wielen  
 Machine à dérouler, mobile et basculable  
 Abwickelmaschine, mobil, drehbar

Article number	Packing	Type
UFH-VLG	1 pc.	25 m - 600 m

*TILL EXHAUSTION OF STOCK*

### Type: UFH-RAS-VLE



Braid hook  
 Vlechthaak  
 Crochet de tressage  
 Gerät zum Flechten von Stahldraht

Article number	Packing	Type
UFH-RAS-VLE	1 pc.	

### Type: UFH-RAS-CUT



Cutter for steel mesh  
 Kniptang voor stalen draadmatten  
 Pince coupante pour treillis  
 Schere für Trägermatte

Article number	Packing	Type
UFH-RAS-CUT	1 pc.	

- 1
- 2
- 3
- 4
- 5
- 6
- 7
- 8
- 9
- 10
- 11



**Type: HNTOOLSET**



Toolset for the Super Size range  
Toolset voor het Super Size assortiment  
Toolset pour la gamme Super Size  
Toolset für das Super Size Angebot

Article number	pc	Type
HNTOOLSET	1 pc.	Super Size

**Type: PK-TOOL**



Wrench for PK/SK fittings with threading  
Sleutel voor PK/SK fittings met draad  
Clé pour raccords PK/SK filtage  
Schlüssel für PK/SK Fittings mit Draht

Article number	Packing	Type
PK-TOOL04	1 pc.	1/2"
PK-TOOL05	1 pc.	3/4"
PK-TOOL06	1 pc.	1"

**Type: PK-TOOLBOX040506**



Set wrenches for PK/SK fittings 1/2" - 1" threading  
Set sleutels voor PK/SK fittings 1/2" tot 1" draad  
Set clés pour raccords PK/SK filtage 1/2" - 1"  
Set Schlüssel für PK/SK Fittings 1/2" bis 1" Draht

Article number	Packing	Type
PK-TOOL- BOX040506	1 pc.	

**Type: PK-TOOLBOX**



Empty plastic case for PK-TOOL04/05/06  
Lege koffer voor PK-TOOL04/05/06  
Coffret pour PK-TOOL04/05/06  
Koffer für PK-TOOLBOX04/05/06

Article number	pc	Type
PK-TOOLBOX	1 pc.	

**Characteristics PK-TOOL**

- ▶ Light weight ratchet key
- ▶ Full grip around fitting profile
- ▶ Plastic body stays intact, even when applying extreme torque
- ▶ Key works as well in clock- as counterclockwise direction
- ▶ Maximum torque transition
- ▶ Size indication on handle
- ▶ Chromed handle
- ▶ Key gripping jaws in anodized aluminum
- ▶ Possibility to grip around mounted fittings due to specific closing mechanism







- 1
- 2
- 3
- 4
- 5
- 6
- 7
- 8
- 9
- 10
- 11

**Type: BCLIP**



Clip-it clip for Henco pipes, single  
 Clip-it beugel voor Henco buizen, enkel  
 Clip-it attache de fixation pour tubes henco, simple  
 Clip-it Bügel für Henco Rohre, einfach

Article number	Box	Type
BCLIP-14 *	100 pc.	Ø14
BCLIP-16	100 pc.	Ø16
BCLIP-1820	100 pc.	Ø18 - 20
BCLIP-26	100 pc.	Ø26
BCLIP-32 *	100 pc.	Ø32
BCLIP-40 *	100 pc.	Ø40
BCLIP-50 *	50 pc.	Ø50

*\* TILL EXHAUSTION OF STOCK*

**Type: JCLIP**



J-clip pipe clips, single  
 J-clip beugels, enkel  
 Attaches de fixation J-clip, simple  
 J-clip Haken, einfach

Article number	Box	Type
JCLIP-1632	200 pc.	Ø16-32, 70 mm

**Type: JCLIP L**



J-clip pipe clips, single  
 J-clip beugels, enkel  
 Attaches de fixation J-clip, simple  
 J-clip Haken, einfach

Article number	Box	Type
JCLIP-1632L	200 pc.	Ø16-32, 97 mm

**Type: JCLIP DOUBLE**



J-clip pipe clips, double  
 J-clip beugels, dubbel  
 Attaches de fixation J-clip, double  
 J-clip Haken, doppelt

Article number	Box	Type
JCLIP-1632D	200 pc.	Ø16-32, 70 mm



### Type: JCLIP DOUBLE L



J-clip pipe clips, double  
 J-clip beugels, dubbel  
 Attaches de fixation J-clip, double  
 J-clip Haken, doppelt

Article number	Box	Type
JCLIP-1632DL	200 pc.	Ø16-32, 97 mm

### Type: NCLIP



N-clip pipe clips, single  
 N-clip beugels, enkel  
 Attaches de fixation N-clip, simple  
 N-clip Haken, einfach

Article number	Box	Type
NCLIP-1618	500 pc.	Ø16-18, 55 mm
NCLIP-20	250 pc.	Ø20 + Ø14, 16, 18 with protection hose
NCLIP-26	250 pc.	Ø26, 55 mm

TILL EXHAUSTION OF STOCK

### Type: NCLIP DOUBLE



N-clip pipe clips, double  
 N-clip beugels, dubbel  
 Attaches de fixation N-clip, double  
 N-clip Haken, doppelt

Article number	Box	Type
NCLIP-20 DOUBLE	250 pc.	Ø20 + Ø14, 16, 18 with protection hose

TILL EXHAUSTION OF STOCK

### Type: PIPEPLUG



Protection cap for pipe  
 Beschermstopje voor buis  
 Capuchon de protection pour tube  
 Schutzkappe für Rohr

Article number	Bag / Box	Type
PIPEPLUG16	100 pc. / 700 pc.	Ø 16

- 1
- 2
- 3
- 4
- 5
- 6
- 7
- 8
- 9
- 10
- 11

**Type: PLP-P-PK**

Galvanised bracket for backplate elbow  
 Gebogen tappuntbeugel gegalvaniseerd  
 Support galvanisé pour culasse sanitaire  
 Halteplatte galvanisiert

Article number	Bag / Box	Type
PLP-P-PK	1 pc. / 30 pc.	

*Interaxis 153mm*

**Type: PLF-P-PK**

Galvanised bracket flat for backplate elbow  
 Vlakke tappuntbeugel gegalvaniseerd  
 Support galvanisé pour culasse sanitaire  
 Halteplatte flach galvanisiert

Article number	Bag / Box	Type
PLF-P-PK	1 pc. / 80 pc.	

*Interaxis 120mm and 153mm*

**Type: TESTPLUG**

Test cap for pipe  
 Afdicht/test stopje voor buis  
 Capuchon de test pour tube  
 Testkappe für Rohr

Article number	Bag / Box	Type
TESTPLUG16	20 pc. / 4000 pc.	
TESTPLUG20	20 pc. / 2000 pc.	

**Type: AK-EK**

Adapter from EK 3/4" to flat sealing  
 Adapter kunststof EK 3/4" naar vlakdichtend  
 Adaptateur EK 3/4" vers joint plat  
 Adapter von EK 3/4" nach AG flachdichtend

Article number	Bag / Box	Type
AK-EK05VD	50 pc. / 1000 pc.	



# CERTIFICATES - CERTIFICATEN - APPROBATIONS - ZERTIFIKATE



GERMANY



AUSTRIA



FRANCE



THE NETHERLANDS



POLAND



DENMARK



ITALY



RUSSIA



SLOVAKIA



ATG SYSTEM CERTIFICATE BELGIUM



NORWAY



FINLAND



HUNGARY



ENGLAND



SWEDEN



USA



ESTONIA



SPAIN



CZECH REPUBLIC



SOUTH AFRICA



# INDEX

Article number	Page	Article number	Page	Article number	Page	Article number	Page
03-160212	6	100-200216	5	10PK-403240	26	1-2606	92
03-180214	6	100-F16R-WZ	15	10PK-502050	26	1-3206	92
03-200216	6	100-F20R-WZ	15	10PK-502650	26	11P-181616	76
03-260320	6	100-FLEX26	10	10PK-503250	26	11P-201616	76
03-320326	6	100-ISO4-14-BL	6	10PK-504050	26	11P-201818	76
03-403533	6	100-ISO4-14-RO	6	10PK-632663	26	11P-202016	76
03-504042	6	100-ISO4-16-BL	6	10PK-633263	26	11P-261620	76
03-634554	6	100-ISO4-16-RO	6	10PK-634063	26	11P-262020	76
03-R160212	12	100-ISO4-20-BL	6	10PK-635063	26	11P-262616	76
03-R200216	12	100-ISO4-20-RO	6	10PK-754075	26, 53	11P-262620	76
03-R260320	12	100-ISO4-R16-BL	13	10PK-755075	26, 53	11P-322026	76
04-160212	6	100-ISO4-R16-RO	13	10PK-756375	26, 53	11P-322626	76
04-200216	6	100-MB	18	10PK-904090	26, 53	11PG-201616	92
04-260320	6	100-MBLACK	18	10PK-905090	26, 53	11PK-161414	27
04-320326	6	100-MG16	18	10PK-906390	26, 53	11PK-181616	27
04-403533	6	100-MR	18	10PK-907590	26, 53	11PK-201616	27
04-504042	6	100-R160212	12	10PKG-201620	44	11PK-201818	27
04-634554	6	100-R16MB	14	10PKG-261626	44	11PK-202016	27
04-R160212	12	100-R16MBLACK	14	10PKG-262026	44	11PK-261616	27
04-R200216	12	100-R16MR	14	10PKG-321632	44	11PK-261620	27
04-R260320	12	100-R180214	12	10PKG-322032	44	11PK-262016	27
05-160212	6	100-R18MR	14	10PKG-322632	44	11PK-262020	27
05-160212-GAS	19	100-R200216	12	10PKG-401640	44	11PK-262616	27
05-180214	6	100-R20MB	14	10PKG-402040	44	11PK-262620	27
05-200216	6	100-R20MR	14	10PKG-402640	44	11PK-322026	27
05-200216-GAS	19	10-160212-KB	5	10PKG-403240	44	11PK-322626	27
05-260320	6	10-1604SN	95	10PKS-322632	48	11PK-402032	27
05-260320-GAS	19	10P-161416	76	10PKS-402640	48	11PK-402632	27
05-260320-SPR	20	10P-181418	76	10PKS-403240	48	11PK-403232	27
05-320326	6	10P-181618	76	10PKS-503250	48	11PK-404026	27
05-320326-GAS	19	10P-201620	76	10PKS-504050	48	11PK-404032	27
05-320326-SPR	20	10P-201820	76	10PKS-633263	48	11PK-502040	27
05-403533	6	10P-261626	76	10PKS-634063	48	11PK-502640	27
05-403533-GAS	19	10P-261826	76	10PKS-635063	48	11PK-503240	27
05-403533-SPR	20	10P-262026	76	10PKW-201620	37	11PK-504040	27
05-504042	6	10P-321632	76	10PKW-261626	37	11PK-754040	27, 53
05-504042-SPR	20	10P-321832	76	10PKW-262026	37	11PK-754050	27, 53
05-634554	6	10P-322032	76	10PKW-321632	37	11PK-754063	27, 53
05-634554-SPR	20	10P-322632	76	10PKW-322032	37	11PK-755050	27, 53
05-756063	6	10PG-262026	88	10PKW-322632	37	11PK-755063	27, 53
05-907076	6	10PK-161416	26	10-R160212-KB	13	11PK-756363	27, 53
05-R160212	12	10PK-16JG1016	26	10SK-201620	62	11PK-904040	27, 53
05-R200216	12	10PK-181418	26	10SK-261626	62	11PK-904050	27, 53
05-R260320	12	10PK-181618	25	10SK-262026	62	11PK-904050	27, 53
100-014MB	8	10PK-201420	26	11-200420	95	11PK-904063	27, 53
100-014MBLACK	8	10PK-201620	26	11-260526	95	11PK-904075	27, 53
100-014MR	8	10PK-201820	26	11-260626	95	11PK-905050	26, 53
100-016MB	8	10PK-20JG1020	26	1-1403C	92	11PK-905063	26, 53
100-016MBLACK	8	10PK-261626	26	1-1404	92	11PK-905075	26, 53
100-016MR	8	10PK-261826	26	1-1604	92	11PK-906363	26, 53
100-018MB	8	10PK-262026	26	1-1604Z	92	11PK-906375	26, 53
100-018MR	8	10PK-321632	26	1-1605	92	11PK-907575	26, 53
100-020MB	8	10PK-321832	26	1-1804	92	11PKG-201616	44
100-020MR	8	10PK-322032	26	1-1805	92	11PKG-202016	44
100-121688	5	10PK-322632	26	1-2004	92	11PKG-261620	44
100-140210	5	10PK-401640	26	1-2004Z	92	11PKG-262016	44
100-160212	5	10PK-402040	26	1-2005	92	11PKG-262020	44
100-180214	5	10PK-402640	26	1-2605	92	11PKG-262616	44

# INDEX

Article number	Page	Article number	Page	Article number	Page	Article number	Page
11PKG-262620	44	13-2628H-2	95	13PKS-400440	49	14PK-631063-N	29
11PKG-322026	44	13P-160416	77	13PKS-400440-N	49	14PK-751075	29, 54
11PKG-322626	44	13P-200420	77	13PKS-400640	49	14PK-751275	29, 54
11PKG-402032	44	13P-200520	77	13PKS-400640-N	49	14PKG-160416	45
11PKG-402632	44	13P-260420	77	13PKS-400740	49	14PKG-200420	45
11PKG-403232	44	13P-260426	77	13PKS-400740-N	49	14PKG-200520	45
11PKG-404026	44	13P-260526	77	13PKS-500450	49	14PKG-260426	45
11PKG-404032	44	13P-320532	77	13PKS-500450-N	49	14PKG-260526	45
11PKS-403232	48	13P-320632	77	13PKS-500550	49	14PKG-260626	45
11PKS-503240	48	13P-320732	77	13PKS-500550-N	49	14PKG-320532	45
11PKS-504040	48	13PG-200420	89	13PKS-500850	49	14PKG-400740	45
11PKW-201616	38	13PG-200520	89	13PKS-500850-N	49	14PKS-320532	50
11PKW-202016	38	13PG-260426	89	13PKS-630463	49	14PKS-320532-N	50
11PKW-261616	38	13PG-260526	89	13PKS-630463-N	49	14PKS-400640	50
11PKW-261620	38	13PG-320632	89	13PKS-631063	49	14PKS-400640-N	50
11PKW-262016	38	13PK-160416BP	28	13PKS-631063-N	49	14PKS-400740	50
11PKW-262020	38	13PK-180418BP	28	13PKW-200520	38	14PKS-400740-N	50
11PKW-262616	38	13PK-200420BP	28	13PKW-200520-N	39	14PKS-500850	50
11PKW-262620	38	13PK-200520	28	13PKW-260426	38	14PKS-500850-N	50
11PKW-322026	38	13PK-260420BP	28	13PKW-260426-N	39	14PKS-631063	50
11PKW-322626	38	13PK-260426BP	28	13PKW-260526	38	14PKS-631063-N	50
11SK-201616	63	13PK-260526	28	13PKW-260526-N	39	14PKW-160416	39
11SK-202016	63	13PK-320532	28	13PKW-320532	38	14PKW-160416-N	39
11SK-261620	63	13PK-320632	28	13PKW-320532-N	39	14PKW-200420	39
11SK-262016	63	13PK-320732	28	13PKW-320632	38	14PKW-200420-N	39
11SK-262020	63	13PK-400640	28	13PKW-320632-N	39	14PKW-200520	39
11SK-262616	63	13PK-400640-N	29	13SK-160416BP	63	14PKW-200520-N	39
11SK-262620	63	13PK-400740	28	13SK-200420BP	63	14PKW-320532	39
120-PRT1620	17	13PK-400740-N	29	13SK-200520	63	14SK-160416	63
12P-161816	76	13PK-500850	28	13SK-260420BP	63	14SK-200420	63
12P-162016	76	13PK-500850-N	29	13SK-260426BP	63	14SK-260426	63
12P-202620	76	13PK-631063	28	13SK-260526	63	15-160212-KB	5
12P-263226	76	13PK-631063-N	29	13-V2622H	96	15P-1414	77
12PK-161816	28	13PK-750675	30, 54	13-V2622H-2	96	15P-1616	77
12PK-162016	28	13PK-751075	28, 53	14P-160416	77	15P-1818	77
12PK-202620	28	13PK-751275	28, 53	14P-180418	77	15P-2020	77
12PK-263226	28	13PK-901490	28, 53	14P-200420	77	15P-2626	77
12PK-324032	28	13PKG-160416BP	45	14P-200520	77	15P-3232	77
12PK-405040	28	13PKG-200420BP	45	14P-260426	77	15PG-1616	89
12PK-407540	28, 53	13PKG-200520	45	14P-260526	77	15PG-2020	89
12PK-409040	28, 53	13PKG-260420BP	45	14P-260626	77	15PG-2626	89
12PK-507550	28, 53	13PKG-260426BP	45	14P-320532	77	15PG-3232	89
12PK-509050	28, 53	13PKG-260526	45	14P-320632	77	15PK-1414	30
12PK-637563	28, 53	13PKG-320532	45	14PK-160416	29	15PK-1616	30
12PK-639063	28, 53	13PKG-320632	45	14PK-180418	29	15PK-1818	30
12PK-759075	28, 53	13PKG-320732	45	14PK-200420	29	15PK-2020	30
12PKG-162016	44	13PKG-400640	45	14PK-200520	29	15PK-2626	30
12PKS-324032	49	13PKG-400740	45	14PK-260426	29	15PK-3232	30
12PKS-405040	49	13PKS-260426	49	14PK-260526	29	15PK-4040	30
12PKW-162016	38	13PKS-260426-N	49	14PK-260626	29	15PK-5050	30
12PKW-202620	38	13PKS-320432	49	14PK-320532	29	15PK-6363	30
12PKW-263226	38	13PKS-320432-N	49	14PK-400640	29	15PK-7575	30, 54
12SK-162016	63	13PKS-320532	49	14PK-400640-N	29	15PK-9090	30, 54
12SK-202620	63	13PKS-320532-N	49	14PK-400740	29	15PKG-1616	45
13-1415-2	95	13PKS-320632	49	14PK-400740-N	29	15PKG-2020	45
13-1615A-2	95	13PKS-320632-N	49	14PK-500850	29	15PKG-2626	45
13-1615HA-2	95	13PKS-320732	49	14PK-500850-N	29	15PKG-3232	45
13-2022HA-2	95	13PKS-320732-N	49	14PK-631063	29	15PKG-4040	45

# INDEX

Article number	Page	Article number	Page	Article number	Page	Article number	Page
15PKS-2626	50	16PKG-3226	46	17PK-6310	31	18HNA-12-N	58
15PKS-3232	50	16PKG-4026	46	17PK-6310-N	31	18HNB-14	58
15PKS-4040	50	16PKG-4032	46	17PK-7510	31, 55	18HNB-14-N	58
15PKS-5050	50	16PKS-3226	50	17PK-7512	31, 55	18P-1404	79
15PKS-6363	50	16PKS-4026	50	17PKG-1604	46	18P-1604	79
15PKW-1616	39	16PKS-4032	50	17PKG-2004	46	18P-1804	79
15PKW-2020	39	16PKS-5032	50	17PKG-2005	46	18P-1805	79
15PKW-2626	39	16PKS-6340	50	17PKG-2605	46	18P-2004	79
15PKW-3232	39	16PKS-6350	50	17PKG-2606	46	18P-2005	79
15-R160212-KB	12	16PKW-2016	40	17PKG-3206	46	18P-2605	79
15SK-1616	64	16PKW-2620	40	17PKG-3207	46	18P-2606	79
15SK-2020	64	16PKW-3216	40	17PKG-4006	46	18P-3206	79
15SK-2626	64	16PKW-3220	40	17PKG-4007	46	18P-3207	79
16HNBA	56	16PKW-3226	40	17PKS-2605	56	18PG-1604	90
16P-1614	78	16SK-2016	64	17PKS-3206	51	18PG-2004	90
16P-1816	78	16SK-2616	64	17PKS-3206-N	51	18PG-2005	90
16P-2014	78	16SK-2620	64	17PKS-3207	51	18PG-2605	90
16P-2016	78	17HNA-10	57	17PKS-3207-N	51	18PG-2606	90
16P-2018	78	17HNA-10-N	57	17PKS-4006	51	18PG-3206	90
16P-2616	78	17HNA-12	57	17PKS-4006-N	51	18PK-1404	32
16P-2618	78	17HNA-12-N	57	17PKS-4007	51	18PK-1604	32
16P-2620	78	17P-1403	78	17PKS-4007-N	51	18PK-1804	32
16P-3216	78	17P-1404	78	17PKS-5008	51	18PK-1805	32
16P-3220	78	17P-1603	78	17PKS-5008-N	51	18PK-2004	32
16P-3226	78	17P-1603	78	17PKS-6310	51	18PK-2005	32
16PG-2016	88	17P-1603DZR	78	17PKS-6310-N	51	18PK-2605	32
16PG-2620	88	17P-1604	78	17PKW-1604	40	18PK-2606	32
16PG-3226	89	17P-1604DZR	78	17PKW-1604-N	40	18PK-3206	32
16PK-1614	30	17P-1804	78	17PKW-2004	40	18PK-3207	32
16PK-1814	30	17P-1805	78	17PKW-2004-N	40	18PK-4006	32
16PK-1816	30	17P-2004	78	17PKW-2005	40	18PK-4006-N	32
16PK-2014	30	17P-2005	78	17PKW-2005-N	40	18PK-4007	32
16PK-2016	30	17P-2605	78	17PKW-2605	40	18PK-4007-N	32
16PK-2018	30	17P-2606	78	17PKW-2605-N	40	18PK-5008	32
16PK-2616	30	17P-3206	78	17PKW-2606	40	18PK-5008-N	32
16PK-2618	30	17P-3207	78	17PKW-2606-N	40	18PK-6310	32
16PK-2620	30	17PG-1604	89	17PKW-3206	40	18PK-6310-N	32
16PK-3216	30	17PG-2004	89	17PKW-3206-N	40	18PK-7506	32, 55
16PK-3220	30	17PG-2005	89	17PKW-3207	40	18PK-7510	32, 55
16PK-3226	30	17PG-2605	89	17PKW-3207-N	40	18PK-7512	32, 55
16PK-4026	30	17PG-2606	89	17SK-1603	64	18PK-9014	32, 55
16PK-4032	30	17PG-3206	89	17SK-1604	64	18PKG-1604	46
16PK-5032	30	17PK-1404	31	17SK-2004	64	18PKG-2004	46
16PK-5040	30	17PK-1604	31	17SK-2005	64	18PKG-2005	46
16PK-6340	30	17PK-1804	31	17SK-2605	64	18PKG-2605	46
16PK-6350	30	17PK-1805	31	17SK-2606	64	18PKG-2606	46
16PK-7540	30, 54	17PK-2004	31	17SKS-2004	65, 68	18PKG-3206	46
16PK-7550	30, 54	17PK-2005	31	17SKS-2005	65, 68	18PKG-3207	46
16PK-7563	30, 54	17PK-2605	31	17SKS-2604	65, 68	18PKG-4006	46
16PK-9040	30, 54	17PK-2606	31	17SKS-2605	65, 68	18PKG-4007	46
16PK-9050	30, 54	17PK-3206	31	17VBS-2005	86, 105	18PKS-2604	51
16PK-9063	30, 54	17PK-3207	31	17VBS-2605	86, 105	18PKS-2604-N	51
16PK-9075	30, 54	17PK-4006	31	17VBS-2606	86, 105	18PKS-2606	51
16PKG-2016	46	17PK-4006-N	31	18HNA-06	58	18PKS-2606-N	51
16PKG-2616	46	17PK-4007	31	18HNA-06-N	58	18PKS-3204	51
16PKG-2620	46	17PK-4007-N	31	18HNA-10	58	18PKS-3204-N	51
16PKG-3216	46	17PK-5008	31	18HNA-10-N	58	18PKS-3206	51
16PKG-3220	46	17PK-5008-N	31	18HNA-12	58	18PKS-3206-N	51

# INDEX

Article number	Page	Article number	Page	Article number	Page	Article number	Page
18PKS-3207	51	1PK-20JG10	22	25-016MB-KB	10	26P-2606	80
18PKS-3207-N	51	1PK-2626	22	25-016MR	8	26P-26205	81
18PKS-4006	51	1PK-3232	22	25-016MR-KB	10	26P-26Z06	81
18PKS-4006-N	51	1PK-4040	22	25-020GASMG	19	26P-3206	80
18PKS-4007	51	1PK-5050	22	25-020MB	8	26P-32Z06	81
18PKS-4007-N	51	1PK-6363	22	25-020MBLACK	8	26P-32Z07	81
18PKS-5008	51	1PK-7575	22,51	25-020MR	8	26PK-1605	33
18PKS-5008-N	51	1PK-9090	22,51	25-026MB	8	26PK-2005	33
18PKS-6310	51	1PKG-1616	42	25-026MR	8	26PK-4008	33
18PKS-6310-N	51	1PKG-2020	42	25-032GASMG	19	26PK-5010	33
18PKW-1604	41	1PKG-2626	42	25-032MB	8	26PK-6312	33
18PKW-1604-N	41	1PKG-3232	42	25-032MR	8	26PKW-1605	41
18PKW-2004	41	1PKG-4040	42	25-160212-GAS	19	26PKW-2005	41
18PKW-2004-N	41	1PKS-2626	47	25-160212-KB	5	26SK-1605	65
18PKW-2005	41	1PKS-3232	47	25-200216	5	26SK-2005	65
18PKW-2005-N	41	1PKS-4040	47	25-200216-KB	5	27HNA	56
18PKW-2605	41	1PKS-5050	47	25-ISO13-32-BL	8	27HNB	56
18PKW-2605-N	41	1PKS-6363	47	25-ISO13-E20-BL	8	27P-2626	81
18PKW-2606	41	1PKW-1616	35	25-ISO13-E26-BL	8	27P-3232	81
18PKW-2606-N	41	1PKW-2020	35	25-ISO26-E16-BL	8	27PK-4040	33
18PKW-3206	41	1PKW-2626	35	25-ISO26-E20-BL	8	27PK-5050	33
18PKW-3206-N	41	1PKW-3232	35	25-ISO26-E26-BL	8	27PK-6363	33
18PKW-3207	41	1SK-1616	61	25-ISO4-26-BL	7	27PK-7575	33, 55
18PKW-3207-N	41	1SK-2020	61	25-ISO4-26-RO	7	27PK-9090	33, 55
18SK-1604	64	1SK-2626	61	25-ISO4-32-BL	7	27PKG-4040	46
18SK-2004	64	200-121688	5	25-ISO4-32-RO	7	27PKS-4040	52
18SK-2005	64	200-140210	5	25-ISO4-R26-BL	13	27PKS-5050	52
18SK-2605	64	200-160212	5	25-ISO4-R26-RO	13	27PKS-6363	52
18SK-2606	64	200-180214	5	25-ISO9-26-BL	7	28-201620	96
18SKS-2004	65, 69	200-F16R-WZ	15	25-ISO9-26-RO	7	28-202016	96
18SKS-2005	65, 69	200-F20R-WZ	15	25-ISO9-32-BL	7	28-262026	96
18SKS-2604	65, 69	200-PRT1620	17	25-ISO9-32-RO	7	28-322632	96
18SKS-2605	65, 69	200-PXC1620	16	25-ISO9-R26-BL	13	28P-14041604-1	81
19P-1605	79	200-PXC1720	16	25-ISO9-R26-RO	13	28P-16041604-1	81
19P-1805	79	200-PXC2020	16	25-MB32	18	28PF-16041604	82
19P-2005	79	200-R160212	12	25-MG32	18	28PF-20042004	82
19PK-1605	32	200-R180214	12	25-MR32	18	28PK-04	33
19PK-2005	32	20P-1604	79	25P-1604	80	28PK-13PK1604BP	34
19PKW-1605	41	2-1616	92	25P-2004	80	28PK-6PK1604BP	34
19PKW-2005	41	2-1818	92	25-R160212-KB	12	28PV-16031603	82
19SK-1605	65, 68	21P-1504	79	25-R16MB	14	28PV-16031603-1	82
19SK-2005	65, 68	2-2020	92	25-R16MR	14	28PV-16041604	82
1HNA	56	2-2626	92	25-R20MB	14	28PV-16041604-1	82
1HNB	56	22P-1604	79	25-R20MBLACK	14	29P-1612-CS	82
1P-1414	73	22P-2004	79	25-R20MR	14	29P-1615-CS	82
1P-1616	73	2-3232	92	26P-14Z04	80	29P-2018-CS	82
1P-1818	73	240-PXC1820	16	26P-1604	80	29P-2022-CS	82
1P-2020	73	24-1615-S	96	26P-1605	80	29P-2622-CS	82
1P-2626	73	24-2022	96	26P-16Z03	81	2P-1404K	73
1P-3232	73	24-2622	96	26P-16Z04	81	2P-1604	73
1PG-1616	87	24-2628	96	26P-16Z05	81	2P-1604K	73
1PG-2020	87	24P-1604	80	26P-1805	80	2P-1804	73
1PG-2626	87	24P-1804	80	26P-18Z05	81	2P-2004	73
1PK-1414	25	24P-2004	80	26P-2004	80	2P-2005	73
1PK-1616	22	25-014MB	8	26P-2005	80	2P-2605	73
1PK-16JG10	22	25-014MR	8	26P-20Z04	81	2PG-1604	87
1PK-1818	22	25-016GASMG	19	26P-20Z05	81	2PG-1604K	87
1PK-2020	22	25-016MB	8	26P-2605	80	2PG-2004	87

# INDEX

Article number	Page	Article number	Page	Article number	Page	Article number	Page
2PG-2005	87	35P-1615P	84	4P-1804	74	50-ISO9-16-RO	7
2PG-2605	87	35P-2018P	84	4P-2004	74	50-ISO9-18-BL	7
2PK-1404BP	22	35P-2022P	84	50-014MB	8	50-ISO9-20-BL	7
2PK-1603	22	35P-3228P	84	50-014MBLACK	8	50-ISO9-20-RO	7
2PK-1604BP	22	36P-1612P	84	50-014MR	8	50-ISO9-26-BL	7
2PK-1604KBP	23	36P-1614P	84	500-160212D	5	50-ISO9-26-RO	7
2PK-1804BP	22	36P-1615P	84	50-016GASMG	19	50-ISO9-R16-BL	13
2PK-2004BP	22	36P-1616P	84	50-016MB	8	50-ISO9-R16-RO	13
2PK-2005	22	36P-2015P	84	50-016MBLACK	8	50-ISO9-R18-BL	13
2PK-2605	22	36P-2018P	84	50-016MR	8	50-ISO9-R20-BL	13
2PKG-1603	42	36P-2022P	84	50-018MB	8	50-ISO9-R20-RO	13
2PKG-1604BP	42	36P-2622P	84	50-018MR	8	50-MB20	18
2PKG-1604KBP	42	36P-3228P	84	50-020GASMG	19	50-MB26	18
2PKG-2004BP	42	36PG-1615P	90	50-020MB	8	50-MBLACK20	18
2PKG-2005	42	36PG-2015P	90	50-020MBLACK	8	50-MBLACK26	18
2PKG-2605	42	36PG-2022P	90	50-020MR	8	50-MG16	18
2PKW-1604	35	36PG-2615P	90	50-026GASMG	19	50-MG20	18
2PKW-1604K	35	36PG-2622P	90	50-026MB	8	50-MG26	18
2PKW-1604-N	35	37P-1412L	84	50-026MBLACK	8	50-MR20	18
2PKW-2004	35	37P-1612L	84	50-026MR	8	50-MR26	18
2PKW-2004-N	35	37P-1615L	84	500-F16R-WZ	15	50-R160212	12
2PKW-2005-N	35	39P-160450	85	500-R160212D	12	50-R16MB	14
2PKW-2605-N	35	3EK-050405	99	50-160212	5	50-R16MBLACK	14
2S-1604K	61	3P-160416	73	50-160212-GAS	19	50-R16MR	14
2SK-1604BP	61	3P-160416VK	74	50-200216	5	50-R18MB	14
2SK-2004BP	61	3P-200420	73	50-200216-GAS	19	50-R18MR	14
2SK-2005	61	3P-200420VK	74	50-260320	5	50-R20MB	14
2SK-2605	61	3PG-160416	87	50-260320-GAS	19	50-R20MR	14
30P-1614S	82	3PG-200420	87	50-260320-SPR	20	50-R260320	12
30P-1615S-2	82	3PK-160416BP	23	50-320326	5	50-R26MB	14
30P-2022S	82	3PK-200420BP	23	50-320326-GAS	19	50-R26MR	14
30P-2622S	82	3PKG-200420BP	43	50-320326-SPR	20	5-1604	93
30PG-1615S-2	90	3PKW-160416	36	50-COMBI16	9	5-1804	93
30PG-2022S	90	3PKW-160416-N	36	50-COMBI16R	14	5-2005	93
30PG-2622S	90	3PKW-200420	36	50-ISO13-16-BL	8	5-2606	93
3-1403C	92	3PKW-200420-N	36	50-ISO13-18-BL	8	52P16	86
3-1404	92	3SK-160416BP	61	50-ISO13-20-BL	8	52P20	86
3-1604	92	3SK-200420BP	61	50-ISO13-26-BL	8	52P26	86
3-1804	92	400-F20R-WZ	15	50-ISO13-E16-BL	8	52P32	86
31P-161616	83	40P-1615S	85	50-ISO13-E18-BL	8	5-3206	93
31P-161620	83	40P-2022S	85	50-ISO13-R16-BL	13	53PK40	34
31P-201616	83	40P-2622S	85	50-ISO13-R20-BL	13	53PK50	34
31P-201620	83	4-1414	93	50-ISO13-R26-BL	13	53PK63	34
31P-202020	83	4-1616	93	50-ISO4-18-BL	7	5P-1404	74
3-2004	92	41P-16	85	50-ISO4-18-RO	7	5P-1603	74
3-2005	92	41P-20	85	50-ISO4-20-BL	7	5P-1604	74
3-2605	92	41P-26	85	50-ISO4-20-RO	7	5P-1804	74
3-2606	92	41S-20	71	50-ISO4-26-BL	7	5P-2004	74
3-3206	92	41S-26	71	50-ISO4-26-RO	7	5P-2005	74
33P-1605	83	41SKS-20	71	50-ISO4-R18-BL	13	5P-2605	74
34P-1604	83	41SKS-26	71	50-ISO4-R18-RO	13	5P-3206	74
34P-1605	83	4-2020	93	50-ISO4-R20-BL	13	5PG-1604	88
34P-1605-CS	83	4-2626	93	50-ISO4-R20-RO	13	5PG-2004	88
34P-2004-CS	83	42P-161615	85	50-ISO4-R26-BL	13	5PG-2005	88
34P-2005	84	42P-202019	85	50-ISO4-R26-RO	13	5PG-2605	88
34P-2005-CS	84	4-3232	93	50-ISO9-14-BL	7	5PK-1404	24
34P-2605-CS	84	43P-161516	86	50-ISO9-14-RO	7	5PK-1604	24
34P-3206	84	4P-1604	74	50-ISO9-16-BL	7	5PK-1804	24

# INDEX

Article number	Page	Article number	Page	Article number	Page	Article number	Page
5PK-2004	24	6-3206	93	6PKW-1603	37	9PK-505050	25
5PK-2005	24	6P-1404	75	6PKW-1603-N	37	9PK-636363	25
5PK-2605	24	6P-1604	75	6PKW-1604	37	9PK-757575	25, 53
5PK-3206	24	6P-1804	75	6PKW-1604-N	37	9PK-909090	25, 53
5PK-4007	24	6P-2004	75	6PKW-2004	37	9PKG-161616	43
5PK-4007-N	24	6P-2005	75	6PKW-2004-N	37	9PKG-202020	43
5PK-5007	24	6P-2605	75	6PKW-2005	37	9PKG-262626	43
5PK-5007-N	24	6P-3206	75	6PKW-2005-N	37	9PKG-323232	43
5PK-5008	24	6PG-1604	88	6PKW-2605	37	9PKG-404040	43
5PK-5008-N	24	6PG-2004	88	6PKW-2605-N	37	9PKS-262626	48
5PK-6310	24	6PG-2005	88	6PKW-3206	37	9PKS-323232	48
5PK-6310-N	24	6PG-2605	88	6PKW-3206-N	37	9PKS-404040	48
5PK-7510	24, 53	6PK-1404BP	24	6SK-1604BP	62	9PKS-505050	48
5PK-7512	24, 53	6PK-1603	24	6SK-2004BP	62	9PKS-636363	48
5PKG-1604	43	6PK-1604BP	24	6SK-2005	62	9PKW-161616	37
5PKG-2004	43	6PK-1804BP	24	6SK-2605	62	9PKW-202020	37
5PKG-2005	43	6PK-2004BP	24	7-1404	94	9PKW-262626	37
5PKG-2605	43	6PK-2005	24	7-1604	94	9PKW-323232	37
5PKG-3206	43	6PK-2605	24	7-160416	94	9SK-161616	62
5PKG-4007	43	6PK-3206	24	7-2004	94	9SK-202020	62
5PKS-3206	47	6PK-4007	24	7P-1605	75	9SK-262626	62
5PKS-3206-N	47	6PK-4007-N	25	7P-1605K	75	AB1420	98
5PKS-4007	47	6PK-5007	24	7P-1605L	75	ABEK04	98
5PKS-4007-N	47	6PK-5007-N	25	7P-1805	75	AD-EKEK	98
5PKS-5007	47	6PK-5008	24	7P-2005	75	AK-EK05VD	174
5PKS-5007-N	47	6PK-5008-N	25	8-161616	94	AN1420	99
5PKS-5008	47	6PK-6310	24	8-181818	94	AT1420	98
5PKS-5008-N	47	6PK-6310-N	25	8-202020	94	BA-1288	150
5PKS-6310	47	6PK-7506	24, 53	8HNA-PK40	56	BA-1410	150
5PKS-6310-N	47	6PK-7510	24, 53	8HNA-PK50	56	BA-1612	150
5PKW-1604	36	6PK-7512	24, 53	8HNA-PK63	56	BA-1814	150
5PKW-1604-N	36	6PK-9014	24, 53	8HNA-PK75	56	BA-2016	150
5PKW-2004	36	6PKG-1604BP	43	8HNB-PK90	56	BA-F41	111
5PKW-2004-N	36	6PKG-2004BP	43	8P-1604	75	BAP-CH1616	110
5PKW-2005	36	6PKG-2005	43	9-140414	95	BAP-CH2626	110
5PKW-2005-N	36	6PKG-2605	43	9-160416	95	BAP-H1616	109
5PKW-2605	36	6PKG-3206	43	9-200420	95	BAP-H1818	109
5PKW-2605-N	36	6PKG-4007	43	9-200520	95	BAP-H2020	109
5PKW-3206	36	6PKS-2604	47	9-260526	95	BAP-H2626	109
5PKW-3206-N	36	6PKS-2604-N	48	9HNA	56	BAP-H3232	109
5SK-1604	62	6PKS-3204	47	9HNB	56	BAP-SK1616	110
5SK-2004	62	6PKS-3204-N	48	9P-141414	75	BAP-SK2020	110
5SK-2005	62	6PKS-3206	47	9P-161616	75	BAP-SK2626	110
5SK-2605	62	6PKS-3206-N	48	9P-181818	75	BAP-SV1610S	110
600-PRT1620	17	6PKS-4004	47	9P-202020	75	BCLIP-14	172
600-PRT1720	17	6PKS-4004-N	48	9P-262626	75	BCLIP-16	172
600-PRT1820	17	6PKS-4007	47	9P-323232	75	BCLIP-1820	172
600-PRT2020	17	6PKS-4007-N	48	9PG-161616	88	BCLIP-26	172
600-PXC1620	16	6PKS-5004	47	9PG-202020	88	BCLIP-32	172
600-PXC1720	16	6PKS-5004-N	48	9PG-262626	88	BCLIP-40	172
600-PXC2020	16	6PKS-5007	47	9PG-323232	88	BCLIP-50	172
6-1404	93	6PKS-5007-N	48	9PK-141414	25	BE12HC	159, 166,
6-1604	93	6PKS-5008	47	9PK-161616	25		167
6-1804	93	6PKS-5008-N	48	9PK-181818	25	BE12HM	159, 166,
6-2004	93	6PKS-6304	47	9PK-202020	25		167
6-2005	93	6PKS-6304-N	48	9PK-262626	25	BE12M-MINI3	163
6-2605	93	6PKS-6310	47	9PK-323232	25	BE14	157
6-2606	93	6PKS-6310-N	48	9PK-404040	25		

# INDEX

Article number	Page	Article number	Page	Article number	Page	Article number	Page
BE14H	159, 165, 166	BE32MINI3	162	DRILLY20	168	M-BMINI3-S	160
BE14M	168	BE40	157	DRILLY26	168	M-BOXBA03	155
BE14MINI3	162	BE50	157	DRILLY32	168	M-BOXBHY	156
BE15C	165	BE63	157	EK12-2	97	M-BOXMINI2	164
BE15HC	159, 166, 167	BE-BOX	159	EK14-2	97	M-BOXMINI3	161
BE15HM	159, 166, 167	BE-MINI	165	EK15	97, 107	M-BOXMINI3-F	162
BE15MMINI	164	BE-MINI3	162	EK16-2	97	M-HP32	166
BE15M-MINI3	163	BE-UNI	158	EK17-2	97	M-LAD03	155
BE15V-MINI3	162	BE-UNISET1	157	EK18-2	97	M-LADMINI3	161
BE16	157	BE-UNISET2	157	EK20-2	97	M-TRANS03	155
BE16H	159, 165, 166	BI-1410	150	EKH16-2	97	M-TRANSMINI2	163
BE16M	168	BI-1612	150	ENDCAP-EK05	71	M-TRANSMINI3	161
BE16MINI	164	BI-1612L	150	H-0212	103	N04	81
BE16MINI3	162	BI-1814	150	H-0212-S	103	N05	81
BE18	157	BI-2016	150	HNA	57	N0605	81
BE18C	165	BI-2016L	150	HNA-ECOLINE-SET	59	NCLIP-1618	173
BE18H	159, 165, 166	BI-2620	150	HNA-EK05	58	NCLIP-20	173
BE18HM	159, 166, 167	BM-16	150	HNA-STOP	58	NCLIP-20DOUBLE	173
BE18M	168	BM-18	150	HNA-U	57	NCLIP-26	173
BE18M-MINI3	163	BM-20	150	HNB	57	PH-1632	154
BE18V-MINI3	162	BM-26	150	HNB-STOP	58	PIPEPLUG16	173
BE20	157	BP04	23	HNB-U	57	PK-TOOL04	170
BE20H	159, 165, 167	CU-10ZONEK-230V	139	HN-PEN	57	PK-TOOL05	170
BE20M	168	CU-10ZONEK-24V	139	HNT00LSET	170	PK-TOOL06	170
BE20MINI	164	CU-12ZONE-RF	143	ISO-BLOCK-L	11	PK-TOOLBOX	170
BE20MINI3	162	CU-6ZONE-230V	137	ISO-BLOCK-S	11	PK-TOOLBOX040506	170
BE22C	165	CU-6ZONE-24V	137	ISO-BOX	83	PLF-P-PK	174
BE22HC	159, 166, 167	CU-6ZONEK-230V	138	JCLIP-1632	172	PLP-P-PK	174
BE22HM	159, 166, 167	CU-6ZONEK-24V	138	JCLIP-1632D	172	PLUG04-B55	168
BE22MMINI	164	CU-6ZONEK-230V	137	JCLIP-1632DL	173	PLUG04-B80	168
BE22M-MINI3	163	CU-6ZONEK-24V	137	JCLIP-1632L	172	PLUG04-R80	168
BE22V-MINI3	162	CU-8ZONEB-RF	143	KS12M	153	PLUG05-B80	168
BE26	157	CU-8ZONE-RF	143	KS14M	153	PLUG05-R80	168
BE26H	159, 166, 167	CU-ACT-230V	140	KS16M	153	PRESSCHECK1432	168
BE26MINI	164	CU-ACT-230V-PLUG	141, 145	KS18M	153	PS-16	152
BE26MINI3	162	CU-ACT-24V-PLUG	141	KS20M	153	RAD04-100H	107
BE28C	165	CU-ANT	144	KS26M	153	RAD04-100V	107
BE28HC	159, 166, 167	CU-DINRAIL	137, 139	KS32M	153	RAD-B	109
BE28M-MINI3	163	CU-MONO-RF	143	KS40M	153	RAD-H	109
BE28V-MINI3	162	CU-PLUGCABLE-15M	141, 145	KS50	153	RADH4-100H	108
BE32	156	CU-PLUGCABLE-2M	141, 145	KS63	153	RADH4-100V	108
BE32H	159, 163, 164	CU-PLUGCABLE-5M	141, 145	KS-K	153	RADK2-R	107
BE32MINI	164	CU-REGB-230V	139	KS-MSET1	152	RADNI-0504	109
		CU-REGB-24V	139	KS-MSET4	152	RADTH-VL	108
		CU-REGB-HC230V	140	KS-P162026	153	RADV-2-R	108
		CU-REGB-HC24V	140	LB50	10	RS1420PRESS	150
		CU-REGB-RF	143	M-BA03	154	RS1420PRESS-N	151
		CU-REGC-230V	140	M-BAT03	154	RS2640PRESS	150
		CU-REGC-24V	140	M-BATMINI2	163	RS32	151
		CU-REGC-RF	144	M-BATMINI3-1.5AH	161	RS63	151
		CU-REGK-230V	140	M-BATMINI3-3.0AH	161	RSEM1420-PERS	151
		CU-REGK-24V	140	M-BH162026	166	RSEM2640-PERS	151
		CU-REGS-RF	144	M-BHY	156	RSEM32	151
		CU-REPEAT	144	M-BHY162026	156	RSEM63	151
		CU-SENS	144	M-BM1620	167	SAFECUT	151
		DRILLY14	168	M-BMINI2-SLB	163	SK-B05	70
		DRILLY16	168	M-BMINI3	160	SK-PIPESTOP16	66
		DRILLY18	168	M-BMINI3-F	160	SK-PIPESTOP20	66

# INDEX

Article number	Page	Article number	Page	Article number	Page	Article number	Page
SK-PIPESTOP26	66	UFH-0505CDWE01	131	UFH-060511-MD	125	UFH-0605MDSS12	128
SK-STOPCLIP16	66	UFH-0505CDWE06	131	UFH-060511-MR	125	UFH-0605MDSS13	128
SK-STOPCLIP16	70	UFH-0505CDWE08	131	UFH-060511-RVSD	128	UFH-0605MDSS14	128
SK-STOPCLIP20	66	UFH-0505CDWE09	131	UFH-060512-MD	125	UFH-0605MDSS15	128
SK-STOPCLIP20	70	UFH-0505LTV07	133	UFH-060512-MR	125	UFH-0626CD01	146
SK-STOPCLIP26	66	UFH-0505LTV08	133	UFH-060512-RVSD	128	UFH-0626CD03	146
SK-STOPCLIP26	70	UFH-0505LTV09	133	UFH-0605CAF01	131	UFH-0626CD04	146
SPLIT-S16	97	UFH-0505LTV10	133	UFH-0605CAF04	131	UFH-0626CD05	146
SPLIT-S20	97	UFH-0505LTV11	133	UFH-0605CD01	130	UFH-0626CD06	146
TESTPLUG16	174	UFH-0505LTV12	133	UFH-0605CD02	130	UFH-0626CD07	146
TESTPLUG20	174	UFH-0505SECO07	132	UFH-0605CD03	130	UFH-ADN10	124
TOOLBOX16202632	158	UFH-0505SECO08	132	UFH-0605CD04	130	UFH-ANC-05	145
TOOLBOX405063	158	UFH-0505SECO09	132	UFH-0605CD05	130	UFH-ANC-06	145
UFH-0405CDP01	130	UFH-0505SECO10	132	UFH-0605CD06	130	UFH-AO03-MZ	127
UFH-0405CDP02	130	UFH-0505SECO11	132	UFH-0605CD07	130	UFH-B0605-VN	130
UFH-0405CDP03	130	UFH-0505SECO12	132	UFH-0605CD08	130	UFH-B0606-M	126
UFH-0405CDP04	130	UFH-0505SECO13	132	UFH-0605CD09	130	UFH-B0606-VN	128
UFH-0405CDP05	130	UFH-0505SECO14	132	UFH-0605CD10	130	UFH-BEND1218	123
UFH-0405CDP06	130	UFH-0505SECO15	132	UFH-0605CD11	130	UFH-BEND20	123
UFH-0405LTV01	133	UFH-0505SECO16	132	UFH-0605CD12	130	UFH-BM0606-VN	129
UFH-0405LTV02	133	UFH-0505SSTE07	133	UFH-0605CD13	130	UFH-BS05-M	127
UFH-0405LTV03	133	UFH-0505SSTE08	133	UFH-0605CD14	130	UFH-BTM0606-M	126
UFH-0405LTV04	133	UFH-0505SSTE09	133	UFH-0605CD15	130	UFH-BTM0606-VN	128
UFH-0405LTV05	133	UFH-0505SSTE10	133	UFH-0605CD16	130	UFH-C191645	134
UFH-0405LTV06	133	UFH-0505SSTE11	133	UFH-0605CD17	130	UFH-C191800	135
UFH-0405LTV07	133	UFH-0505SSTE12	133	UFH-0605CD18	130	UFH-C191974	134
UFH-0405LTV08	133	UFH-0505SSTN07	132	UFH-0605CD19	130	UFH-C191976	134
UFH-0405LTV09	133	UFH-0505SSTN08	132	UFH-0605CD20	130	UFH-C192071	135
UFH-0405LTV11	133	UFH-0505SSTN09	132	UFH-0605MDK02	129	UFH-CAB-I1000	148
UFH-0405LTV12	133	UFH-0505SSTN10	132	UFH-0605MDK02	129	UFH-CAB-I400	148
UFH-0405SECO01	133	UFH-0505SSTN11	132	UFH-0605MDK03	129	UFH-CAB-I600	148
UFH-0405SECO02	133	UFH-0505SSTN12	132	UFH-0605MDK03	129	UFH-CAB-I800	148
UFH-0405SECO03	133	UFH-060502-MD	125	UFH-0605MDK04	129	UFH-CAB-I800	148
UFH-0405SECO04	133	UFH-060502-MR	125	UFH-0605MDK04	129	UFH-CAB-O1000	148
UFH-0405SECO05	133	UFH-060502-RVSD	127	UFH-0605MDK05	129	UFH-CAB-O400	148
UFH-0405SECO06	133	UFH-060503-MD	125	UFH-0605MDK05	129	UFH-CAB-O600	148
UFH-0405SSTE01	133	UFH-060503-MR	125	UFH-0605MDK06	129	UFH-CAB-O800	148
UFH-0405SSTE02	133	UFH-060504-MD	125	UFH-0605MDK06	129	UFH-CP	131
UFH-0405SSTE03	133	UFH-060504-MR	125	UFH-0605MDK07	129	UFH-DH40	123
UFH-0405SSTE04	133	UFH-060504-RVSD	128	UFH-0605MDK07	129	UFH-DP200	123
UFH-0405SSTE05	133	UFH-060505-MD	125	UFH-0605MDK08	129	UFH-DRY-B	120
UFH-0405SSTE06	133	UFH-060505-MR	125	UFH-0605MDK08	129	UFH-DRY-GP100-2	119
UFH-0405SSTN01	132	UFH-060505-RVSD	127	UFH-0605MDK09	129	UFH-DRY-VD100	120
UFH-0405SSTN02	132	UFH-060506-MD	125	UFH-0605MDK10	129	UFH-ESK060303-M	127
UFH-0405SSTN03	132	UFH-060506-MR	125	UFH-0605MDK10	129	UFH-ESK060303-VN	128
UFH-0405SSTN04	132	UFH-060506-RVSD	127	UFH-0605MDK11	129	UFH-FOIL50	121
UFH-0405SSTN05	132	UFH-060507-MD	125	UFH-0605MDK11	129	UFH-FOIL90	121
UFH-0405SSTN06	132	UFH-060507-MR	125	UFH-0605MDK12	129	UFH-FOIL-ALU	122
UFH-0505CDP07	130	UFH-060507-RVSD	128	UFH-0605MDK12	129	UFH-FOIL-CLIP25	122
UFH-0505CDP08	130	UFH-060508-MD	125	UFH-0605MDSS02	128	UFH-FOIL-N	121
UFH-0505CDP09	130	UFH-060508-MR	125	UFH-0605MDSS03	128	UFH-GKT	126
UFH-0505CDP10	130	UFH-060508-RVSD	128	UFH-0605MDSS04	128	UFH-H5004	145
UFH-0505CDP11	130	UFH-060509-MD	125	UFH-0605MDSS05	128	UFH-ISOBOARD-GV	123
UFH-0505CDP12	130	UFH-060509-MR	125	UFH-0605MDSS06	128	UFH-ISOBOARD-S	122
UFH-0505CDP13	130	UFH-060509-RVSD	128	UFH-0605MDSS07	128	UFH-ISODRY-25	119
UFH-0505CDP14	130	UFH-060510-MD	125	UFH-0605MDSS08	128	UFH-ISOPRO11	113
UFH-0505CDP15	130	UFH-060510-MR	125	UFH-0605MDSS09	128	UFH-ISOPRO30	113
UFH-0505CDP16	130	UFH-060510-RVSD	128	UFH-0605MDSS10	128	UFH-ISOPRO-AD11	114
				UFH-0605MDSS11	128	UFH-ISOPRO-AD30	114



# INDEX

Article number	Page	Article number	Page	Article number	Page
UFH-MAX95	134	V-060403	101	VEK-060506-Z	102
UFH-MAXB55	134	V-060404	101	VEK-060507	102
UFH-M-D	125	V-060405	101	VEK-060507-Z	102
UFH-MDK-CON	129	V-060406	101	VEK-060508	102
UFH-P18-GP10	119	V-060407	101	VEK-060508-Z	102
UFH-P18-GP18	117	V-060408	101	VEK-060509	102
UFH-P18-GP18V	118	V-060408-Z	101	VEK-060509-Z	102
UFH-P18-WN	119	V-060409	101	VEK-060510	102
UFH-PGKTA	125	V-070405-Z	101	VEK-060510-Z	102
UFH-PGKTA-TH	126	V-070406-Z	101	VISION SET 16	66
UFH-PLUG80	122	V-070407-Z	101	VISION SET 20	66
UFH-PRO	113	V-070408-Z	101	VISION SET 26	66
UFH-PRO-ADA	114	V-070410-Z	101	VISION-KEY16	66
UFH-PRO-DIA	113	VB050502-BLAUW	104	VISION-KEY20	66
UFH-PRO-IND	114	VB050502-ROOD	104	VISION-KEY26	66
UFH-RAS10	115	VB050503-BLAUW	104	VR-EK05	104
UFH-RAS15	115	VB050503-ROOD	104	VS-05	103
UFH-RAS20	115	VB050504-BLAUW	104	VS-0504	103
UFH-RAS25	115	VB050504-ROOD	104	VS-06	103
UFH-RAS-BIND15A	116	VB060502-BLAUW	104	VS-0604	103
UFH-RAS-BIND15B	116	VB060502-ROOD	104	VS-0605	103
UFH-RAS-CLIP16	116	VB060503-BLAUW	104	VS-07	103
UFH-RAS-CLIP18	116	VB060503-ROOD	104	VS-ENDCAP	69
UFH-RAS-CLIP20	116	VB060504-BLAUW	104	VS-ENDCAP-M	70
UFH-RAS-CUT	169	VB060504-ROOD	104	VSK-1616	67
UFH-RAS-RB3	116	VB-EK05	104	VSK-161616	67
UFH-RAS-VLE	169	VBS-05	105	VSK-161616	67
UFH-SCOTCH-66	118	VBS050502-BL	105	VSK-161616	67
UFH-TACK	118	VBS050502-RO	105	VSK-161616	67
UFH-TACK-38K	117	VBS050503-BL	105	VSK-161616	67
UFH-TACK-40	117	VBS050503-RO	105	VSK-161616	67
UFH-TACK-60	117	VBS050504-BL	105	VSK-161616	67
UFH-TACK-KLS15	116	VBS050504-RO	105	VSK-161616	67
UFH-TACK-KLS20	116	VBS-06	105	VSK-161616	67
UFH-TACK-KLS25	116	VBS060502-BL	105	VSK-161616	67
UFH-TACK-KLS30	116	VBS060502-RO	105	VSK-161616	67
UFH-TACK-ROL20	117	VBS060503-BL	105	VSK-161616	67
UFH-TACK-ROL25	117	VBS060503-RO	105	VSK-161616	67
UFH-TACK-ROL30	117	VBS060504-BL	105	VSK-161616	67
UFH-TACK-ROL35	117	VBS060504-RO	105	VSK-161616	67
UFH-TM050-M	123	VDSK-20	70	VSK-161616	67
UFH-UP-12	120	VDSK-26	70	VSK-161616	67
UFH-UP-14	120	VEK-050504-Z	102	VSK-161616	67
UFH-UP-14M1	120	VEK-050505-Z	102	VSK-161616	67
UFH-UP-16	120	VEK-050506-Z	102	VSK-161616	67
UFH-UP-16M1	120	VEK-050507-Z	102	VSK-161616	67
UFH-UP-1826M1Z	121	VEK-050508-Z	102	VSK-161616	67
UFH-UP-20	120	VEK-050509-Z	102	VSK-161616	67
UFH-UP-CUP50	121	VEK-060502	102	VSK-161616	67
UFH-VLA	169	VEK-060502-Z	102	VSK-161616	67
UFH-VLA-STR	169	VEK-060502-ZV	103	VSK-161616	67
UFH-VLG	169	VEK-060503	102	VSK-161616	67
V-050403-Z	101	VEK-060503-Z	102	VSK-161616	67
V-050404-Z	101	VEK-060504	102	VSK-161616	67
V-050405-Z	101	VEK-060504-Z	102	VSK-161616	67
V-050406-Z	101	VEK-060505	102	VSK-161616	67
V-060402	101	VEK-060505-Z	102	VSK-161616	67
V-060402-Z	101	VEK-060506	102	VSK-161616	67





# WE CARE TO CONNECT



Henco Industries NV | Toekomstlaan 27, 2200 Herentals | Tel. +32 14 28 56 60 | [www.henco.be](http://www.henco.be)

Technische veranderingen en drukfouten voorbehouden

Technical amendments and printing errors reserved

Changements techniques et fautes d'impression sous réserve

Technische Änderungen und Druckfehler vorbehalten