

# PROGRAMME DE LIVRAISON



|            |                                |     |
|------------|--------------------------------|-----|
| <b>9.1</b> | <b>Tubes</b>                   | 125 |
| <b>9.2</b> | <b>Raccords à sertir Henco</b> | 135 |
| <b>9.3</b> | <b>Henco Vision</b>            | 159 |



## 9.1 Tubes

### TYPE: STANDARD ROULEAU (PE-Xc/AL/PE-Xc)

Henco tube multicouche (Rouleau)

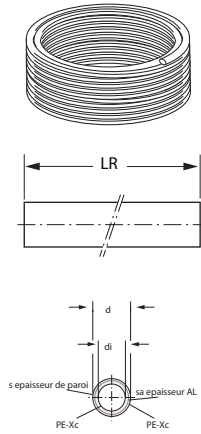

| Rouleau |     |     |                      |
|---------|-----|-----|----------------------|
| d       | di  | s   | LR                   |
| mm      | mm  | mm  | m                    |
| 12      | 8,8 | 1,6 | 100 - 200            |
| 14      | 10  | 2   | 50 - 100 - 200       |
| 16      | 12  | 2   | 50 - 100 - 200 - 500 |
| 18      | 14  | 2   | 100 - 200            |
| 20      | 16  | 2   | 25 - 50 - 100        |
| 26      | 20  | 3   | 50                   |
| 32      | 26  | 3   | 50                   |

### TYPE: STANDARD BARRE (PE-Xc/AL/PE-Xc)

Henco tube multicouche (Barre)

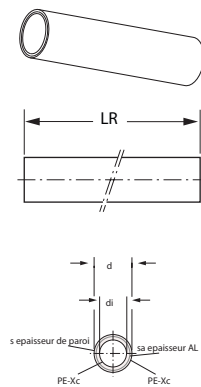

| Barre |    |     |           |
|-------|----|-----|-----------|
| d     | di | s   | LR        |
| mm    | mm | mm  | m         |
| 16    | 12 | 2   | 3 - 4 - 5 |
| 18    | 14 | 2   | 3 - 4 - 5 |
| 20    | 16 | 2   | 3 - 4 - 5 |
| 26    | 20 | 3   | 3 - 4 - 5 |
| 32    | 26 | 3   | 3 - 4 - 5 |
| 40    | 33 | 3,5 | 3 - 4 - 5 |
| 50    | 42 | 4   | 3 - 4 - 5 |
| 63    | 54 | 4,5 | 3 - 4 - 5 |
| 75    | 63 | 6   | 5         |
| 90    | 76 | 7   | 5         |

# 9 PROGRAMME DE LIVRAISON

- 1
- 2
- 3
- 4
- 5
- 6
- 7
- 8
- 9
- 10
- 11

## TYPE: RIXc ROULEAU (PE-Xc/AL/PE-Xc)

Henco tube multicouche RIXc (Rouleau)

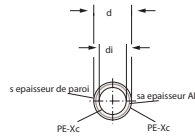
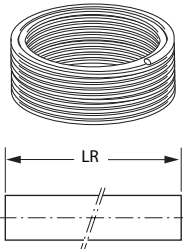

| Rouleau |    |    |                      |
|---------|----|----|----------------------|
| d       | di | s  | LR                   |
| mm      | mm | mm | m                    |
| 16      | 12 | 2  | 50 - 100 - 200 - 500 |
| 18      | 14 | 2  | 100 - 200            |
| 20      | 16 | 2  | 100                  |
| 26      | 20 | 3  | 50                   |

## TYPE: RIXc BARRE (PE-Xc/AL/PE-Xc)

Henco tube multicouche RIXc (Barre)

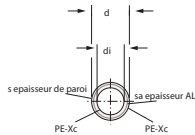
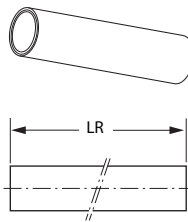

| Barre |    |    |           |
|-------|----|----|-----------|
| d     | di | s  | LR        |
| mm    | mm | mm | m         |
| 16    | 12 | 2  | 3 - 4 - 5 |
| 18    | 14 | 2  | 3 - 4 - 5 |
| 20    | 16 | 2  | 3 - 4 - 5 |
| 26    | 20 | 3  | 3 - 4 - 5 |



## TYPE: STANDARD ISO (PE-Xc/AL/PE-Xc)

Préisolé (Rouleau)

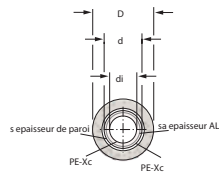
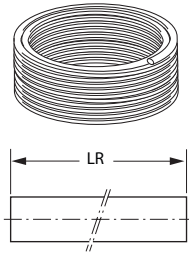
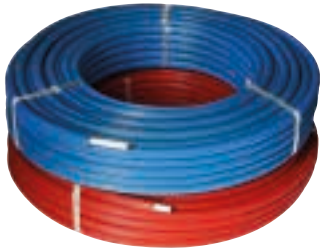

Rouleau: 6 mm insulation

| d  | di | D  | s  | LR      |
|----|----|----|----|---------|
| mm | mm | mm | mm | m       |
| 14 | 10 | 26 | 2  | 100     |
| 16 | 12 | 28 | 2  | 100     |
| 18 | 14 | 30 | 2  | 50      |
| 20 | 16 | 32 | 2  | 50      |
| 26 | 20 | 38 | 3  | 25 - 50 |
| 32 | 26 | 44 | 3  | 25      |

Rouleau: 10 mm insulation

| d  | di | D  | s  | LR      |
|----|----|----|----|---------|
| mm | mm | mm | mm | m       |
| 14 | 10 | 34 | 2  | 50      |
| 16 | 12 | 36 | 2  | 50      |
| 18 | 14 | 38 | 2  | 50      |
| 20 | 16 | 40 | 2  | 50      |
| 26 | 20 | 46 | 3  | 25 - 50 |
| 32 | 26 | 52 | 3  | 25      |

Rouleau: 13 mm insulation

| d  | di | D  | s  | LR |
|----|----|----|----|----|
| mm | mm | mm | mm | m  |
| 16 | 12 | 42 | 2  | 50 |
| 18 | 14 | 44 | 2  | 50 |
| 20 | 16 | 46 | 2  | 50 |
| 26 | 20 | 52 | 3  | 50 |
| 32 | 26 | 58 | 3  | 25 |

# 9 PROGRAMME DE LIVRAISON

- 1
- 2
- 3
- 4
- 5
- 6
- 7
- 8
- 9
- 10
- 11

## TYPE: GAINÉ

Gainé (Rouleau)

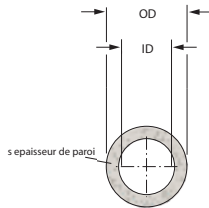
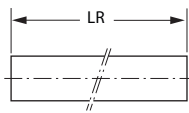
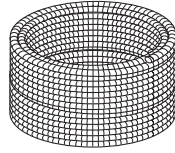

| Rouleau |      |    |      |     |
|---------|------|----|------|-----|
| d       | OD   | ID | s    | LR  |
| mm      | mm   | mm | mm   | m   |
| 14      | 25   | 20 | 5    | 100 |
| 16      | 25   | 20 | 5    | 100 |
| 18      | 25   | 20 | 5    | 100 |
| 20      | 28   | 23 | 5,55 | 50  |
| 26      | 34   | 29 | 6    | 50  |
| 32      | 45,6 | 39 | 6,9  | 25  |

## TYPE: STANDARD AVEC GAINÉ (PE-Xc/AL/PE-Xc)

Avec gainé (Rouleau)

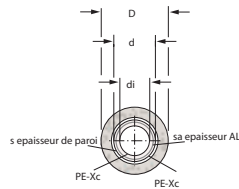
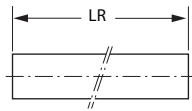
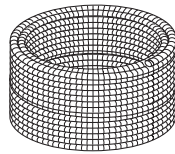

| Rouleau |    |    |    |               |
|---------|----|----|----|---------------|
| d       | di | D  | s  | LR            |
| mm      | mm | mm | mm | m             |
| 14      | 10 | 25 | 2  | 25 - 50 - 100 |
| 16      | 12 | 25 | 2  | 25 - 50 - 100 |
| 18      | 14 | 25 | 2  | 50 - 100      |
| 20      | 16 | 28 | 2  | 25 - 50 - 100 |
| 26      | 20 | 35 | 3  | 25 - 50       |
| 32      | 26 | 39 | 3  | 25            |

## TYPE: RIXc PIPE IN PIPE (PE-Xc/AL/PE-Xc)

Avec gainé (Rouleau)

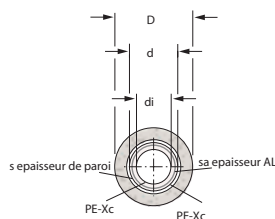
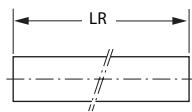
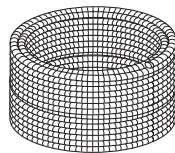

| Rouleau |    |    |    |               |
|---------|----|----|----|---------------|
| d       | di | D  | s  | LR            |
| mm      | mm | mm | mm | m             |
| 16      | 12 | 25 | 2  | 25 - 50 - 100 |
| 18      | 14 | 25 | 2  | 50 - 100      |
| 20      | 16 | 28 | 2  | 25 - 50 - 100 |
| 26      | 20 | 35 | 3  | 50            |



- 1
- 2
- 3
- 4
- 5
- 6
- 7
- 8
- 9
- 10
- 11

### TYPE: HENCO COMBI®

Henco Combi (Rouleau)

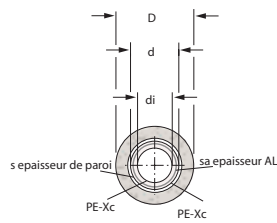
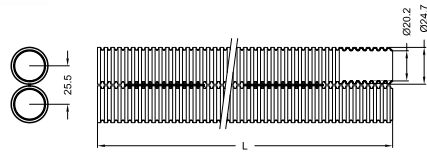
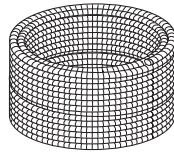

| Rouleau |    |    |    |    |
|---------|----|----|----|----|
| d       | di | D  | s  | LR |
| mm      | mm | mm | mm | m  |
| 16      | 12 | 25 | 2  | 50 |

### TYPE: COMBI ISO

Henco Combi iso 6 mm (Rouleau)

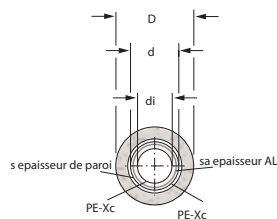
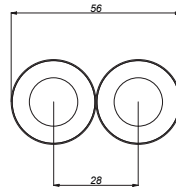
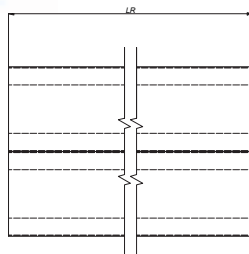
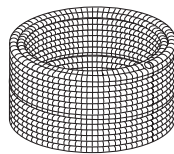

| Rouleau |    |    |    |    |
|---------|----|----|----|----|
| d       | di | D  | s  | LR |
| mm      | mm | mm | mm | m  |
| 16      | 12 | 28 | 2  | 50 |

## 9 PROGRAMME DE LIVRAISON

1

2

3

4

5

6

7

8

9

10

11

### TYPE: LB

Double courbe radiateur, tube Henco Ø 16, bout rattaché

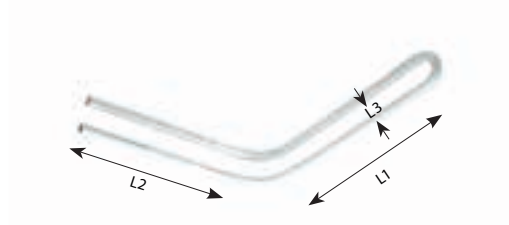

| LB       |     |     |    |
|----------|-----|-----|----|
| ART. NR. | L1  | L2  | L3 |
|          | mm  | mm  | mm |
| LB50     | 420 | 358 | 50 |

### TYPE: ISO-BLOCK-S

Double courbe radiateur, Ø 16, avec isolation, bout rattaché

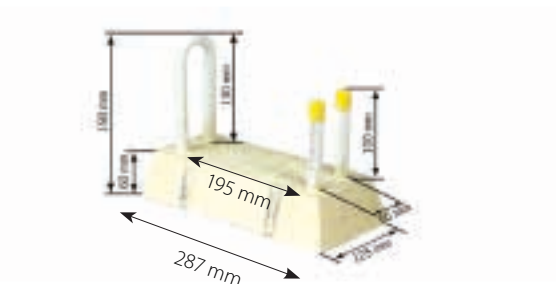

| ISO-BLOCK   |      |    |
|-------------|------|----|
| ART. NR.    | Type | LR |
|             |      | mm |
| ISO-BLOCK-S | S    | 1M |

### TYPE: ISO-BLOCK-L

Double courbe radiateur, Ø 16, avec isolation, bout rattaché

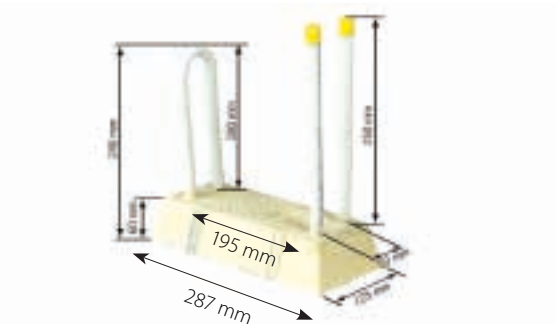

| ISO-BLOCK   |      |    |
|-------------|------|----|
| ART. NR.    | Type | LR |
|             |      | mm |
| ISO-BLOCK-L | L    | 1M |



## TYPE: ISO-BLOCK-XL

Double courbe radiateur, Ø 16, avec isolation, embout fermé



| ISO-BLOCK    |      |          |
|--------------|------|----------|
| Art. Nr.     | Type | LR<br>mm |
| ISO-BLOCK-XL | XL   | 1M       |

## TYPE: FLOOR-RIXc (PE-Xc/AL/PE-Xc)

Henco tube multicouche (Rouleau)\*

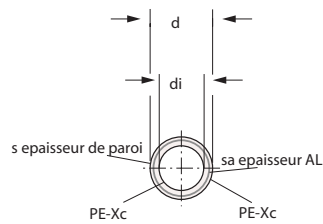
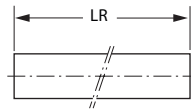
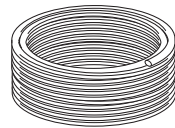

| Rouleau |    |    |                      |
|---------|----|----|----------------------|
| d       | di | s  | LR                   |
| mm      | mm | mm | m                    |
| 16      | 12 | 2  | 50 - 100 - 200 - 500 |
| 20      | 16 | 2  | 100 - 200 - 400      |

\*60°C / 6 Bar

- 1
- 2
- 3
- 4
- 5
- 6
- 7
- 8
- 9
- 10
- 11



## 9 PROGRAMME DE LIVRAISON

1

2

3

4

5

6

7

8

9

10

11

### TYPE: 5L PE-Xc (PE-Xc/EVOH/PE-Xc)

Henco 5L PE-Xc tube PE-Xc/EVOH/PE-Xc (Rouleau)

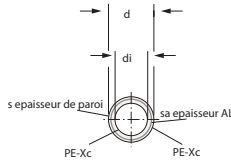
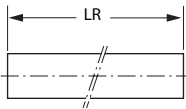
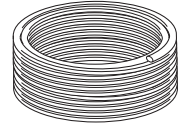

Rouleau

| d<br>mm | di<br>mm | s<br>mm | LR<br>m   |
|---------|----------|---------|-----------|
| 16      | 12       | 2       | 200 - 600 |
| 17      | 13       | 2       | 200 - 600 |
| 18      | 14       | 2       | 240       |
| 20      | 16       | 2       | 200 - 600 |

### TYPE: 5L PE-RT (PE-RT/EVOH/PE-RT)

Henco 5L PE-RT tube PE-RT/EVOH/PE-RT (Rouleau)

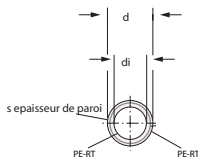
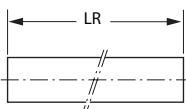
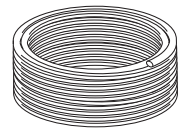

Rouleau

| d<br>mm | di<br>mm | s<br>mm | LR<br>m         |
|---------|----------|---------|-----------------|
| 16      | 12       | 2       | 120 - 200 - 600 |
| 17      | 13       | 2       | 600             |
| 18      | 14       | 2       | 600             |
| 20      | 16       | 2       | 600             |



- 1
- 2
- 3
- 4
- 5
- 6
- 7
- 8
- 9
- 10
- 11

### TYPE: STANDARD GAS ROULEAU (PE-Xc/AL/PE-Xc)

Henco tube multicouche (Rouleau)

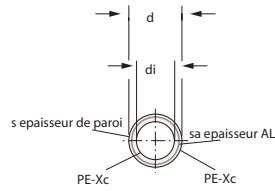
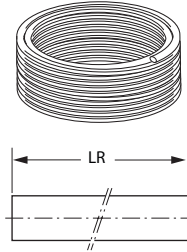

| Rouleau |    |    |    |
|---------|----|----|----|
| d       | di | s  | LR |
| mm      | mm | mm | m  |
| 16      | 12 | 2  | 50 |
| 20      | 16 | 2  | 50 |
| 26      | 20 | 3  | 50 |
| 32      | 26 | 3  | 50 |

### TYPE: STANDARD GAS BARRE (PE-Xc/AL/PE-Xc)

Henco tube multicouche (Barre)

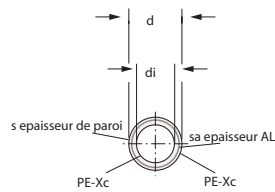
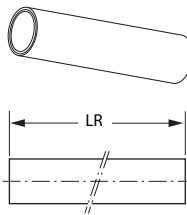

| Barre |    |     |    |
|-------|----|-----|----|
| d     | di | s   | LR |
| mm    | mm | mm  | m  |
| 16    | 12 | 2   | 5  |
| 20    | 16 | 2   | 5  |
| 26    | 20 | 3   | 5  |
| 32    | 26 | 3   | 5  |
| 40    | 33 | 3,5 | 5  |

# 9 PROGRAMME DE LIVRAISON

- 1
- 2
- 3
- 4
- 5
- 6
- 7
- 8
- 9
- 10
- 11

## TYPE: GAINÉ GAS

Gaine (Rouleau)

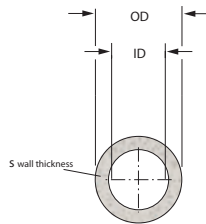
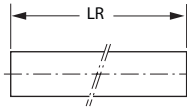
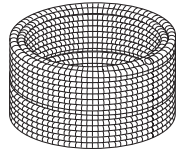

| Rouleau |      |      |     |    |
|---------|------|------|-----|----|
| d       | OD   | ID   | s   | LR |
| mm      | mm   | mm   | mm  | m  |
| 16      | 23   | 19   | 4   | 50 |
| 20      | 28   | 23   | 5   | 50 |
| 26      | 34   | 29,5 | 4,5 | 50 |
| 32      | 41,5 | 36,5 | 5   | 25 |

## TYPE: STANDARD AVEC GAINÉ GAS (PE-Xc/AL/PE-Xc)

Avec gaine (Rouleau)

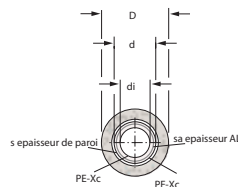
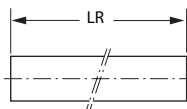
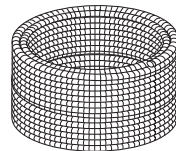

| Rouleau |    |    |    |    |
|---------|----|----|----|----|
| d       | di | D  | s  | LR |
| mm      | mm | mm | mm | m  |
| 16      | 12 | 23 | 2  | 50 |
| 20      | 16 | 28 | 2  | 50 |
| 26      | 20 | 35 | 3  | 50 |
| 32      | 26 | 39 | 3  | 25 |



## 9.2 Raccords à sertir Henco

**TYPE: 1PK**  
**TYPE: 1PKW**

Coude 90°

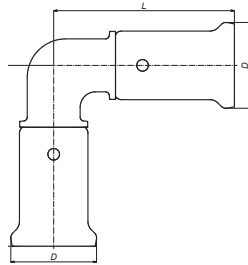

| ART. NR.  | L<br>mm | D<br>mm |
|-----------|---------|---------|
| 1PK-1414  | 46      | 20      |
| 1PK-1616  | 47      | 22      |
| 1PK-1818  | 48      | 24      |
| 1PK-2020  | 49      | 26      |
| 1PK-2626  | 54      | 32      |
| 1PK-3232  | 72      | 39      |
| 1PK-4040  | 78      | 47      |
| 1PK-5050  | 100     | 57      |
| 1PK-6363  | 116     | 70      |
| 1PKW-1616 | 47      | 22      |
| 1PKW-2020 | 49      | 26      |
| 1PKW-2626 | 54      | 32      |
| 1PKW-3232 | 72      | 39      |

**TYPE: 2PK**  
**TYPE: 2PKW**  
**TYPE: 2PKW-N**

Culasse pour sanitaire

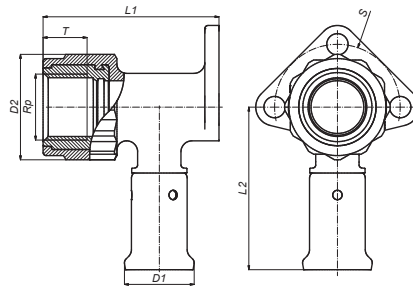

| ART. NR.    | L1<br>mm | L2<br>mm | D1<br>mm | D2<br>mm | Rp   | T<br>mm | S<br>mm |
|-------------|----------|----------|----------|----------|------|---------|---------|
| 2PK-1404BP* | 56       | 52       | 20       | 33       | 1/2" | 13,5    | 40      |
| 2PK-1603    | 56       | 52       | 22       | 33       | 3/8" | 13,5    | 40      |
| 2PK-1604BP* | 56       | 52       | 22       | 33       | 1/2" | 13,5    | 40      |
| 2PK-1804BP* | 56       | 52       | 24       | 33       | 1/2" | 13,5    | 40      |
| 2PK-2004BP* | 56       | 52       | 26       | 33       | 1/2" | 13,5    | 40      |
| 2PK-2005    | 61       | 58       | 26       | 40       | 3/4" | 15,5    | 46      |
| 2PK-2605    | 66       | 58       | 32       | 40       | 3/4" | 15,5    | 46      |
| 2PKW-1604   | 56       | 52       | 22       | 33       | 1/2" | 13,5    | 40      |
| 2PKW-2004   | 56       | 52       | 26       | 33       | 1/2" | 13,5    | 40      |
| 2PKW-2005   | 61       | 58       | 26       | 40       | 3/4" | 15,5    | 46      |
| 2PKW-2605   | 66       | 58       | 32       | 40       | 3/4" | 15,5    | 46      |
| 2PKW-1604-N | 56       | 52       | 22       | 33       | 1/2" | 13,5    | 40      |
| 2PKW-2004-N | 56       | 52       | 26       | 33       | 1/2" | 13,5    | 40      |
| 2PKW-2005-N | 61       | 58       | 26       | 40       | 3/4" | 15,5    | 46      |
| 2PKW-2605-N | 66       | 58       | 32       | 40       | 3/4" | 15,5    | 46      |

\* Avec bouchon noir BP04 1/2"

## 9 PROGRAMME DE LIVRAISON

### TYPE: 2PK-K TYPE: 2PKW-K

Culasse pour sanitaire, modèle court

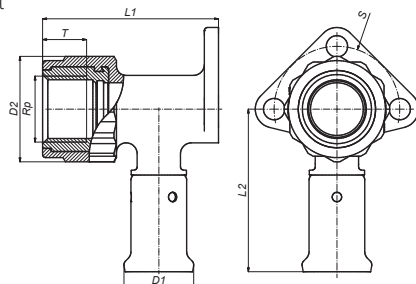

| ART. NR.     | L1 | L2 | D1 | D2 | Rp   | T   | S  |
|--------------|----|----|----|----|------|-----|----|
|              | mm | mm | mm | mm |      | mm  | mm |
| 2PK-1604KBP* | 40 | 52 | 22 | 33 | 1/2" | 3,5 | 45 |
| 2PKW-1604K   | 40 | 52 | 22 | 33 | 1/2" | 3,5 | 45 |

\* Avec bouchon noir BP04 1/2

### TYPE: 3PK TYPE: 3PKW TYPE: 3PKW-N

Culasse double pour sanitaire, modèle court

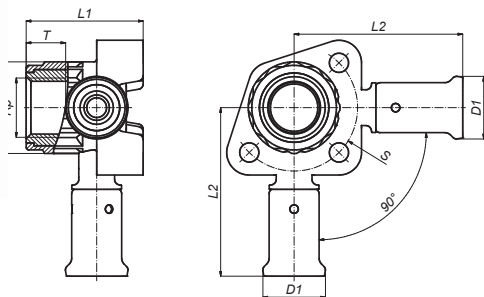

| ART. NR.      | L1   | L2 | D1 | D2 | Rp   | T  | S  |
|---------------|------|----|----|----|------|----|----|
|               | mm   | mm | mm | mm |      | mm | mm |
| 3PK-160416BP* | 42   | 60 | 22 | 33 | 1/2" | 14 | 45 |
| 3PK-200420BP* | 43,5 | 60 | 26 | 33 | 1/2" | 14 | 45 |
| 3PKW-160416   | 42   | 60 | 22 | 33 | 1/2" | 14 | 45 |
| 3PKW-200420   | 43,5 | 60 | 26 | 33 | 1/2" | 14 | 45 |
| 3PKW-160416-N | 42   | 60 | 22 | 33 | 1/2" | 14 | 45 |
| 3PKW-200420-N | 43,5 | 60 | 26 | 33 | 1/2" | 14 | 45 |

\* Avec bouchon noir BP04 1/2

### TYPE: BP04

Bouchon noir pour 1/2" nipple femelle

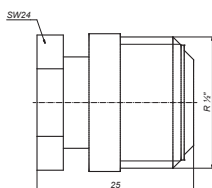

| ART. NR. | L  | R    |
|----------|----|------|
|          | mm |      |
| BP04*    | 25 | 1/2" |



**TYPE: 5PK**  
**TYPE: 5PKW**  
**TYPE: 5PKW-N**  
 Coude 90° mâle

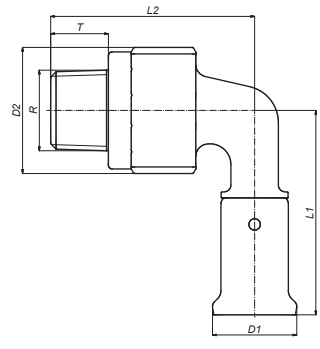

| ART. NR.    | L1  | L2   | D1 | D2   | R    | T    |
|-------------|-----|------|----|------|------|------|
|             | mm  | mm   | mm | mm   |      | mm   |
| 5PK-1404    | 54  | 54   | 20 | 33   | 1/2" | 13,5 |
| 5PK-1604    | 54  | 54   | 22 | 33   | 1/2" | 13,5 |
| 5PK-1804    | 54  | 54   | 24 | 33   | 1/2" | 13,5 |
| 5PK-2004    | 56  | 56   | 26 | 33   | 1/2" | 13,5 |
| 5PK-2005    | 58  | 58   | 26 | 40   | 3/4" | 14,5 |
| 5PK-2605    | 60  | 62   | 32 | 40   | 3/4" | 14,5 |
| 5PK-3206    | 75  | 68,5 | 39 | 45,5 | 1"   | 16,5 |
| 5PK-4007    | 84  | 77   | 47 | 56,5 | 5/4" | 19   |
| 5PK-5007    | 101 | 86   | 57 | 56,5 | 5/4" | 19   |
| 5PK-5008    | 101 | 93   | 57 | 70   | 6/4" | 20   |
| 5PK-6310    | 126 | 118  | 70 | 90   | 2"   | 23   |
| 5PKW-1604   | 54  | 54   | 22 | 33   | 1/2" | 13,5 |
| 5PKW-2004   | 56  | 56   | 26 | 33   | 1/2" | 13,5 |
| 5PKW-2005   | 58  | 58   | 26 | 40   | 3/4" | 14,5 |
| 5PKW-2605   | 60  | 62   | 32 | 40   | 3/4" | 14,5 |
| 5PKW-3206   | 75  | 68,5 | 39 | 45,5 | 1"   | 16,5 |
| 5PKW-1604-N | 54  | 54   | 22 | 33   | 1/2" | 13,5 |
| 5PKW-2004-N | 56  | 56   | 26 | 33   | 1/2" | 13,5 |
| 5PKW-2005-N | 58  | 58   | 26 | 40   | 3/4" | 14,5 |
| 5PKW-2605-N | 60  | 62   | 32 | 40   | 3/4" | 14,5 |
| 5PKW-3206-N | 75  | 68,5 | 39 | 45,5 | 1"   | 16,5 |

**TYPE: 6PK**  
**TYPE: 6PKW**  
 Coude 90° femelle

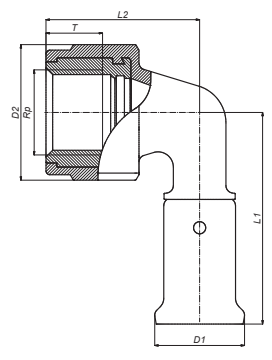

| ART. NR.    | L1  | L2   | D1 | D2   | Rp   | T    |
|-------------|-----|------|----|------|------|------|
|             | mm  | mm   | mm | mm   |      | mm   |
| 6PK-1404BP* | 53  | 39   | 20 | 33   | 1/2" | 13,5 |
| 6PK-1603    | 53  | 39   | 22 | 33   | 3/8" | 13,5 |
| 6PK-1604BP* | 53  | 39   | 22 | 33   | 1/2" | 13,5 |
| 6PK-1804BP* | 53  | 39   | 24 | 33   | 1/2" | 13,5 |
| 6PK-2004BP* | 53  | 39   | 26 | 33   | 1/2" | 13,5 |
| 6PK-2005    | 60  | 47,5 | 26 | 40   | 3/4" | 15,5 |
| 6PK-2605    | 60  | 47,5 | 32 | 40   | 3/4" | 15,5 |
| 6PK-3206    | 75  | 58,5 | 39 | 45,5 | 1"   | 18   |
| 6PK-4007    | 81  | 72   | 47 | 56,5 | 5/4" | 21   |
| 6PK-5007    | 101 | 77   | 57 | 56,5 | 5/4" | 21   |
| 6PK-5008    | 101 | 82   | 57 | 70   | 6/4" | 25   |
| 6PK-6310    | 126 | 104  | 70 | 90   | 2"   | 30   |
| 6PKW-1603   | 53  | 39   | 22 | 33   | 3/8" | 13,5 |
| 6PKW-1604   | 53  | 39   | 26 | 33   | 1/2" | 13,5 |
| 6PKW-2004   | 53  | 39   | 26 | 33   | 1/2" | 13,5 |
| 6PKW-2005   | 60  | 47,5 | 26 | 40   | 3/4" | 15,5 |
| 6PKW-2605   | 60  | 47,5 | 32 | 40   | 3/4" | 15,5 |
| 6PKW-3206   | 75  | 58,5 | 39 | 45,5 | 1"   | 18   |
| 6PKW-1603-N | 53  | 39   | 22 | 33   | 3/8" | 13,5 |
| 6PKW-1604-N | 53  | 39   | 26 | 33   | 1/2" | 13,5 |
| 6PKW-2004-N | 53  | 39   | 26 | 33   | 1/2" | 13,5 |
| 6PKW-2005-N | 60  | 47,5 | 26 | 40   | 3/4" | 15,5 |
| 6PKW-2605-N | 60  | 47,5 | 32 | 40   | 3/4" | 15,5 |
| 6PKW-3206-N | 75  | 58,5 | 39 | 45,5 | 1"   | 18   |

\* Avec bouchon noir BP04 1/2"

## 9 PROGRAMME DE LIVRAISON

1

2

3

4

5

6

7

8

9

10

11

**TYPE: 9PK**

**TYPE: 9PKW**

Pièce en T

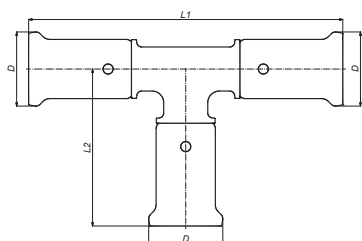

| ART. NR.    | L1<br>mm | L2<br>mm | D<br>mm |
|-------------|----------|----------|---------|
| 9PK-141414  | 93       | 46       | 20      |
| 9PK-161616  | 94       | 47       | 22      |
| 9PK-181818  | 97       | 48,5     | 24      |
| 9PK-202020  | 98       | 49       | 26      |
| 9PK-262626  | 107      | 53       | 32      |
| 9PK-323232  | 140      | 70       | 39      |
| 9PK-404040  | 151      | 75       | 47      |
| 9PK-505050  | 191      | 95       | 57      |
| 9PK-636363  | 232      | 117      | 70      |
| 9PKW-161616 | 94       | 47       | 22      |
| 9PKW-202020 | 98       | 49       | 26      |
| 9PKW-262626 | 107      | 53       | 32      |
| 9PKW-323232 | 140      | 70       | 39      |



**TYPE: 10PK**  
**TYPE: 10PKW**

Pièce en T réduit

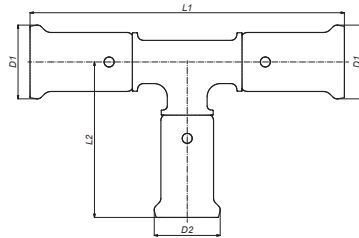

| ART. NR.     | L1<br>mm | L2<br>mm | D1<br>mm | D2<br>mm |
|--------------|----------|----------|----------|----------|
| 10PK-161416  | 95       | 47,5     | 22       | 20       |
| 10PK-181418  | 97       | 49       | 24       | 20       |
| 10PK-181618  | 97       | 49       | 24       | 22       |
| 10PK-201420  | 95       | 49       | 26       | 20       |
| 10PK-201620  | 94       | 49       | 26       | 22       |
| 10PK-201820  | 98       | 50,5     | 26       | 24       |
| 10PK-261626  | 98       | 53       | 32       | 22       |
| 10PK-261826  | 100      | 53       | 32       | 24       |
| 10PK-262026  | 103      | 54       | 32       | 26       |
| 10PK-321632  | 133      | 58       | 39       | 22       |
| 10PK-321832  | 133      | 58       | 39       | 24       |
| 10PK-322032  | 133      | 58       | 39       | 26       |
| 10PK-322632  | 133      | 58       | 39       | 32       |
| 10PK-401640  | 120      | 59       | 47       | 22       |
| 10PK-402040  | 123      | 59       | 47       | 26       |
| 10PK-402640  | 136      | 61       | 47       | 32       |
| 10PK-403240  | 144      | 75       | 47       | 39       |
| 10PK-502050  | 153      | 65       | 57       | 26       |
| 10PK-502650  | 160      | 64       | 57       | 32       |
| 10PK-503250  | 167      | 77       | 57       | 39       |
| 10PK-504050  | 184      | 81       | 57       | 47       |
| 10PK-632663  | 187      | 71       | 70       | 32       |
| 10PK-633263  | 193      | 84       | 70       | 39       |
| 10PK-634063  | 212      | 87       | 70       | 47       |
| 10PK-635063  | 220      | 103      | 70       | 57       |
| 10PKW-201620 | 94       | 49       | 26       | 22       |
| 10PKW-261626 | 98       | 53       | 32       | 22       |
| 10PKW-262026 | 103      | 54       | 32       | 26       |
| 10PKW-321632 | 133      | 58       | 39       | 22       |
| 10PKW-322032 | 133      | 58       | 39       | 26       |
| 10PKW-322632 | 133      | 58       | 39       | 32       |

- 1
- 2
- 3
- 4
- 5
- 6
- 7
- 8
- 9
- 10
- 11





- 1
- 2
- 3
- 4
- 5
- 6
- 7
- 8
- 9
- 10
- 11

**TYPE: 11PK**  
**TYPE: 11PKW**

Pièce en T 2x réduit

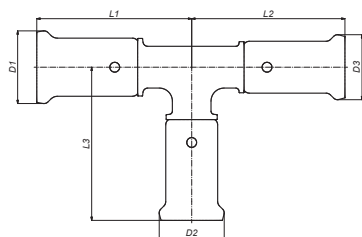

| ART. NR.     | L1<br>mm | L2<br>mm | L3<br>mm | D1<br>mm | D2<br>mm | D3<br>mm |
|--------------|----------|----------|----------|----------|----------|----------|
| 11PK-161414  | 47,5     | 47,5     | 47       | 22       | 20       | 20       |
| 11PK-181616  | 48,5     | 49,3     | 49,3     | 24       | 22       | 22       |
| 11PK-201616  | 47,5     | 49,5     | 49,5     | 26       | 22       | 22       |
| 11PK-201818  | 49,5     | 50,3     | 50,2     | 26       | 24       | 24       |
| 11PK-202016  | 49,5     | 51       | 49,5     | 26       | 26       | 22       |
| 11PK-261616  | 51,8     | 51,8     | 51,8     | 32       | 22       | 22       |
| 11PK-261620  | 51,8     | 51,8     | 53,5     | 32       | 22       | 26       |
| 11PK-262016  | 51,5     | 51,5     | 53,2     | 32       | 26       | 22       |
| 11PK-262020  | 51,8     | 51,8     | 54       | 32       | 26       | 26       |
| 11PK-262616  | 53,5     | 56       | 53,5     | 32       | 32       | 22       |
| 11PK-262620  | 53,5     | 54,5     | 53,2     | 32       | 32       | 26       |
| 11PK-322026  | 66,8     | 60       | 58,5     | 39       | 26       | 32       |
| 11PK-322626  | 66,3     | 60       | 58,5     | 39       | 32       | 32       |
| 11PK-402032  | 62       | 62       | 59       | 47       | 26       | 39       |
| 11PK-402632  | 68       | 72       | 61,4     | 47       | 32       | 39       |
| 11PK-403232  | 70,5     | 70,5     | 72       | 47       | 39       | 39       |
| 11PK-404026  | 74,5     | 70,5     | 75,5     | 47       | 47       | 32       |
| 11PK-404032  | 74,5     | 74,5     | 75,5     | 47       | 47       | 39       |
| 11PK-502040  | 78       | 65       | 64       | 57       | 26       | 47       |
| 11PK-502640  | 80       | 65       | 64       | 57       | 32       | 47       |
| 11PK-503240  | 84       | 68       | 77       | 57       | 39       | 47       |
| 11PK-504040  | 88       | 73       | 77       | 57       | 47       | 47       |
| 11PKW-201616 | 47,5     | 49,5     | 49,5     | 26       | 22       | 22       |
| 11PKW-202016 | 49,5     | 51       | 49,5     | 26       | 26       | 22       |
| 11PKW-261616 | 51,8     | 51,8     | 51,8     | 32       | 22       | 22       |
| 11PKW-261620 | 51,8     | 51,8     | 53,5     | 32       | 22       | 26       |
| 11PKW-262016 | 51,5     | 51,5     | 53,2     | 32       | 26       | 22       |
| 11PKW-262020 | 51,8     | 51,8     | 54       | 32       | 26       | 26       |
| 11PKW-262616 | 53,5     | 56       | 53,5     | 32       | 32       | 22       |
| 11PKW-262620 | 53,5     | 54,5     | 53,2     | 32       | 32       | 26       |
| 11PKW-322026 | 66,8     | 60       | 58,5     | 39       | 26       | 32       |
| 11PKW-322626 | 66,3     | 60       | 58,5     | 39       | 32       | 32       |

**TYPE: 12PK**  
**TYPE: 12PKW**

Pièce en T agrandi

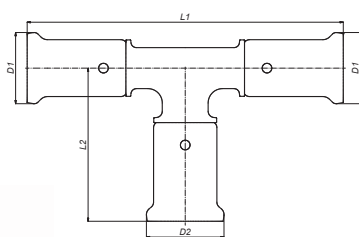

| ART. NR.     | L1<br>mm | L2<br>mm | D1<br>mm | D2<br>mm |
|--------------|----------|----------|----------|----------|
| 12PK-161816  | 98       | 48,5     | 22       | 24       |
| 12PK-162016  | 101      | 48,5     | 22       | 26       |
| 12PK-202620  | 108      | 52       | 26       | 32       |
| 12PK-263226  | 114      | 66       | 32       | 39       |
| 12PK-324032  | 145      | 69       | 39       | 47       |
| 12PK-405040  | 154      | 88       | 47       | 57       |
| 12PKW-162016 | 101      | 48,5     | 22       | 26       |
| 12PKW-202620 | 108      | 52       | 26       | 32       |
| 12PKW-263226 | 114      | 66       | 32       | 39       |



**TYPE: 13PK**  
**TYPE: 13PKW**  
**TYPE: 13PKW-N**

Pièce en T femelle

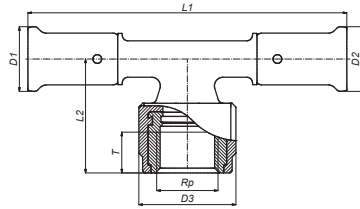

| ART. NR.       | L1  | L2   | D1 | D2 | D3   | Rp   | T    |
|----------------|-----|------|----|----|------|------|------|
|                | mm  | mm   | mm | mm | mm   |      | mm   |
| 13PK-160416BP* | 109 | 39   | 22 | 22 | 33   | 1/2" | 13,5 |
| 13PK-180418BP* | 109 | 39   | 24 | 24 | 33   | 1/2" | 13,5 |
| 13PK-200420BP* | 109 | 39   | 26 | 26 | 33   | 1/2" | 13,5 |
| 13PK-200520    | 119 | 47   | 26 | 26 | 40   | 3/4" | 15,5 |
| 13PK-260420BP* | 109 | 43   | 32 | 26 | 33   | 1/2" | 13,5 |
| 13PK-260426BP* | 109 | 43   | 32 | 32 | 33   | 1/2" | 13,5 |
| 13PK-260526    | 119 | 47   | 32 | 32 | 40   | 3/4" | 15,5 |
| 13PK-320532    | 146 | 52,5 | 39 | 39 | 40   | 3/4" | 15,5 |
| 13PK-320632    | 149 | 56   | 39 | 39 | 45,5 | 1"   | 18   |
| 13PK-320732    | 161 | 66   | 39 | 39 | 56,5 | 5/4" | 21   |
| 13PK-400640    | 153 | 63   | 47 | 47 | 45,5 | 1"   | 18   |
| 13PK-400740    | 158 | 69   | 47 | 47 | 56,5 | 5/4" | 21   |
| 13PK-500850    | 202 | 84   | 57 | 57 | 70   | 6/4" | 25   |
| 13PK-631063    | 242 | 104  | 70 | 70 | 90   | 2"   | 30   |
| 13PKW-160416   | 109 | 39   | 22 | 22 | 33   | 1/2" | 13,5 |
| 13PKW-200420   | 109 | 39   | 26 | 26 | 33   | 1/2" | 13,5 |
| 13PKW-200520   | 119 | 47   | 26 | 26 | 40   | 3/4" | 15,5 |
| 13PKW-260426   | 109 | 43   | 32 | 32 | 33   | 1/2" | 13,5 |
| 13PKW-260526   | 119 | 47   | 32 | 32 | 40   | 3/4" | 15,5 |
| 13PKW-320532   | 146 | 52,5 | 39 | 39 | 40   | 3/4" | 15,5 |
| 13PKW-320632   | 149 | 56   | 39 | 39 | 45,5 | 1"   | 18   |
| 13PKW-160416-N | 109 | 39   | 22 | 22 | 33   | 1/2" | 13,5 |
| 13PKW-200420-N | 109 | 39   | 26 | 26 | 33   | 1/2" | 13,5 |
| 13PKW-200520-N | 119 | 47   | 26 | 26 | 40   | 3/4" | 15,5 |
| 13PKW-260426-N | 109 | 43   | 32 | 32 | 33   | 1/2" | 13,5 |
| 13PKW-260526-N | 119 | 47   | 32 | 32 | 40   | 3/4" | 15,5 |
| 13PKW-320532-N | 146 | 52,5 | 39 | 39 | 40   | 3/4" | 15,5 |
| 13PKW-320632-N | 149 | 56   | 39 | 39 | 45,5 | 1"   | 18   |

\* Avec bouchon noir BP04 1/2"

- 1
- 2
- 3
- 4
- 5
- 6
- 7
- 8
- 9
- 10
- 11

## 9 PROGRAMME DE LIVRAISON

**TYPE: 14PK**  
**TYPE: 14PKW**  
**TYPE: 14PKW-N**

Pièce en T mâle

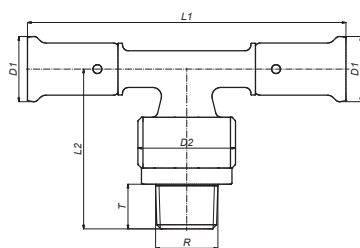

| ART. NR.       | L1  | L2  | D1 | D2   | R    | T    |
|----------------|-----|-----|----|------|------|------|
|                | mm  | mm  | mm | mm   |      | mm   |
| 14PK-160416    | 109 | 54  | 22 | 33   | 1/2" | 13,5 |
| 14PK-180418    | 109 | 54  | 24 | 33   | 1/2" | 13,5 |
| 14PK-200420    | 109 | 54  | 26 | 33   | 1/2" | 13,5 |
| 14PK-200520    | 114 | 58  | 26 | 40   | 3/4" | 14,5 |
| 14PK-260426    | 119 | 60  | 32 | 33   | 1/2" | 13,5 |
| 14PK-260526    | 119 | 63  | 32 | 40   | 3/4" | 14,5 |
| 14PK-260626    | 124 | 65  | 32 | 45,5 | 1"   | 16,5 |
| 14PK-320532    | 146 | 66  | 39 | 40   | 3/4" | 14,5 |
| 14PK-400640    | 150 | 74  | 47 | 45,5 | 1"   | 16,5 |
| 14PK-400740    | 161 | 80  | 47 | 56,5 | 5/4" | 19   |
| 14PK-500850    | 202 | 88  | 57 | 70   | 6/4" | 20   |
| 14PK-631063    | 236 | 109 | 70 | 90   | 2"   | 23   |
| 14PKW-160416   | 109 | 54  | 22 | 33   | 1/2" | 13,5 |
| 14PKW-200420   | 109 | 54  | 26 | 33   | 1/2" | 13,5 |
| 14PKW-200520   | 114 | 58  | 26 | 40   | 3/4" | 14,5 |
| 14PKW-320532   | 146 | 66  | 39 | 40   | 3/4" | 14,5 |
| 14PKW-160416-N | 109 | 54  | 22 | 33   | 1/2" | 13,5 |
| 14PKW-200420-N | 109 | 54  | 26 | 33   | 1/2" | 13,5 |
| 14PKW-200520-N | 114 | 58  | 26 | 40   | 3/4" | 14,5 |

**TYPE: 15PK**  
**TYPE: 15PKW**

Manchon

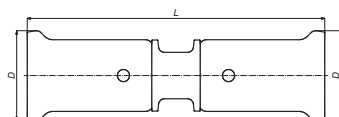

| ART. NR.   | L   | D  |
|------------|-----|----|
|            | mm  | mm |
| 15PK-1414  | 74  | 20 |
| 15PK-1616  | 74  | 22 |
| 15PK-1818  | 75  | 24 |
| 15PK-2020  | 76  | 26 |
| 15PK-2626  | 81  | 32 |
| 15PK-3232  | 103 | 39 |
| 15PK-4040  | 106 | 47 |
| 15PK-5050  | 141 | 57 |
| 15PK-6363  | 171 | 70 |
| 15PKW-1616 | 74  | 22 |
| 15PKW-2020 | 76  | 26 |
| 15PKW-2626 | 81  | 32 |
| 15PKW-3232 | 103 | 39 |



**TYPE: 16PK**  
**TYPE: 16PKW**  
 Réduction

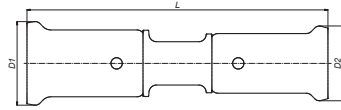

| ART. NR.   | L<br>mm | D1<br>mm | D2<br>mm |
|------------|---------|----------|----------|
| 16PK-1614  | 80,6    | 22       | 20       |
| 16PK-1814  | 82      | 24       | 20       |
| 16PK-1816  | 80,7    | 24       | 22       |
| 16PK-2014  | 78,9    | 26       | 20       |
| 16PK-2016  | 80,8    | 26       | 22       |
| 16PK-2018  | 80,7    | 26       | 24       |
| 16PK-2616  | 84      | 32       | 22       |
| 16PK-2618  | 85      | 32       | 24       |
| 16PK-2620  | 84      | 32       | 26       |
| 16PK-3216  | 107     | 38,5     | 22       |
| 16PK-3220  | 103     | 38,5     | 26       |
| 16PK-3226  | 102     | 38,5     | 32       |
| 16PK-4026  | 113,8   | 46,5     | 32       |
| 16PK-4032  | 115     | 46,5     | 38,5     |
| 16PK-5032  | 136     | 57       | 39       |
| 16PK-5040  | 143     | 57       | 46,5     |
| 16PK-6340  | 174     | 70       | 47       |
| 16PK-6350  | 173     | 70       | 57       |
| 16PKW-2016 | 80,8    | 26       | 22       |
| 16PKW-2616 | 84      | 32       | 22       |
| 16PKW-2620 | 84      | 32       | 26       |
| 16PKW-3216 | 107     | 38,5     | 22       |
| 16PKW-3220 | 103     | 38,5     | 26       |
| 16PKW-3226 | 102     | 38,5     | 32       |

- 1
- 2
- 3
- 4
- 5
- 6
- 7
- 8
- 9
- 10
- 11

## 9 PROGRAMME DE LIVRAISON

**TYPE: 17PK**  
**TYPE: 17PKW**  
**TYPE: 17PKW-N**

Raccord droit mâle

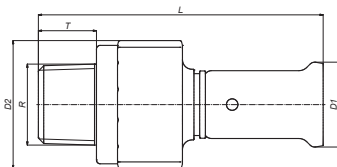

| ART. NR.     | L<br>mm | D1<br>mm | D2<br>mm | R    | T<br>mm |
|--------------|---------|----------|----------|------|---------|
| 17PK-1404    | 75      | 20       | 33       | 1/2" | 13,5    |
| 17PK-1604    | 75      | 22       | 33       | 1/2" | 13,5    |
| 17PK-1804    | 75      | 24       | 33       | 1/2" | 13,5    |
| 17PK-1805    | 77      | 24       | 40       | 3/4" | 14,5    |
| 17PK-2004    | 75      | 26       | 33       | 1/2" | 13,5    |
| 17PK-2005    | 77      | 26       | 40       | 3/4" | 14,5    |
| 17PK-2605    | 77      | 32       | 40       | 3/4" | 14,5    |
| 17PK-2606    | 80      | 32       | 45,5     | 1"   | 16,5    |
| 17PK-3206    | 91      | 39       | 45,5     | 1"   | 16,5    |
| 17PK-3207    | 99      | 39       | 56,5     | 5/4" | 19      |
| 17PK-4006    | 84      | 47       | 45,5     | 1"   | 16,5    |
| 17PK-4007    | 93      | 47       | 56,5     | 5/4" | 19      |
| 17PK-5008    | 142     | 57       | 89       | 6/4" | 20      |
| 17PK-6310    | 142     | 70       | 90       | 2"   | 23      |
| 17PKW-1604   | 75      | 22       | 33       | 1/2" | 13,5    |
| 17PKW-2004   | 75      | 26       | 33       | 1/2" | 13,5    |
| 17PKW-2005   | 77      | 26       | 40       | 3/4" | 14,5    |
| 17PKW-2605   | 77      | 32       | 40       | 3/4" | 14,5    |
| 17PKW-2606   | 80      | 32       | 45,5     | 1"   | 16,5    |
| 17PKW-3206   | 91      | 39       | 45,5     | 1"   | 16,5    |
| 17PKW-3207   | 99      | 39       | 56,5     | 5/4" | 19      |
| 17PKW-1604-N | 75      | 22       | 33       | 1/2" | 13,5    |
| 17PKW-2004-N | 75      | 26       | 33       | 1/2" | 13,5    |
| 17PKW-2005-N | 77      | 26       | 40       | 3/4" | 14,5    |
| 17PKW-2605-N | 77      | 32       | 40       | 3/4" | 14,5    |
| 17PKW-2606-N | 80      | 32       | 45,5     | 1"   | 16,5    |
| 17PKW-3206-N | 91      | 39       | 45,5     | 1"   | 16,5    |
| 17PKW-3207-N | 99      | 39       | 56,5     | 5/4" | 19      |



**TYPE: 18PK**  
**TYPE: 18PKW**  
**TYPE: 18PKW-N**

Raccord droit femelle

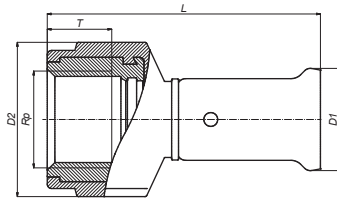

| ART. NR.     | L     | D1 | D2   | Rp   | T    |
|--------------|-------|----|------|------|------|
|              | mm    | mm | mm   |      | mm   |
| 18PK-1404    | 59,5  | 20 | 33   | 1/2" | 13,5 |
| 18PK-1604    | 59,5  | 22 | 33   | 1/2" | 13,5 |
| 18PK-1804    | 59,5  | 24 | 33   | 1/2" | 13,5 |
| 18PK-1805    | 63    | 24 | 40   | 3/4" | 15,5 |
| 18PK-2004    | 59,5  | 26 | 33   | 1/2" | 13,5 |
| 18PK-2005    | 63    | 26 | 40   | 3/4" | 15,5 |
| 18PK-2605    | 63    | 32 | 40   | 3/4" | 15,5 |
| 18PK-2606    | 70,5  | 32 | 45,5 | 1"   | 18   |
| 18PK-3206    | 82    | 39 | 45,5 | 1"   | 18   |
| 18PK-3207    | 90    | 39 | 56,5 | 5/4" | 21   |
| 18PK-4006    | 74,5  | 47 | 45,5 | 1"   | 18   |
| 18PK-4007    | 85    | 47 | 56,5 | 5/4" | 21   |
| 18PK-5008    | 107,5 | 57 | 70   | 6/4" | 25   |
| 18PK-6310    | 131   | 70 | 90   | 2"   | 30   |
| 18PKW-1604   | 59,5  | 22 | 33   | 1/2" | 13,5 |
| 18PKW-2004   | 59,5  | 26 | 33   | 1/2" | 13,5 |
| 18PKW-2005   | 63    | 26 | 40   | 3/4" | 15,5 |
| 18PKW-2605   | 63    | 32 | 40   | 3/4" | 15,5 |
| 18PKW-2606   | 70,5  | 32 | 45,5 | 1"   | 18   |
| 18PKW-3206   | 82    | 39 | 45,5 | 1"   | 18   |
| 18PKW-3207   | 90    | 39 | 56,5 | 5/4" | 21   |
| 18PKW-1604-N | 59,5  | 22 | 33   | 1/2" | 13,5 |
| 18PKW-2004-N | 59,5  | 26 | 33   | 1/2" | 13,5 |
| 18PKW-2005-N | 63    | 26 | 40   | 3/4" | 15,5 |
| 18PKW-2605-N | 63    | 32 | 40   | 3/4" | 15,5 |
| 18PKW-2606-N | 70,5  | 32 | 45,5 | 1"   | 18   |
| 18PKW-3206-N | 82    | 39 | 45,5 | 1"   | 18   |
| 18PKW-3207-N | 90    | 39 | 56,5 | 5/4" | 21   |

- 1
- 2
- 3
- 4
- 5
- 6
- 7
- 8
- 9
- 10
- 11

## 9 PROGRAMME DE LIVRAISON

1  
2  
3  
4  
5  
6  
7  
8  
9  
10  
11

### TYPE: 19PK TYPE: 19PKW

Raccord à sertir avec écrou à visser eurocone

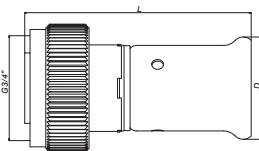

| ART. NR.   | L<br>mm | D<br>mm | G    |
|------------|---------|---------|------|
| 19PK-1605  | 55      | 22      | 3/4" |
| 19PK-2005  | 55      | 26      | 3/4" |
| 19PKW-1605 | 55      | 22      | 3/4" |
| 19PKW-2005 | 55      | 26      | 3/4" |

### TYPE: 26PK TYPE: 26PKW

Raccord avec écrou et joint plat

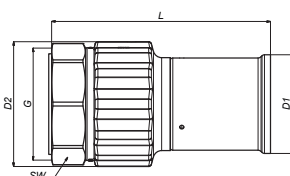
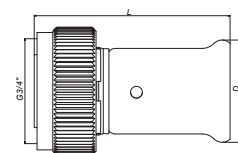

| ART. NR.   | L<br>mm | D<br>mm | G    |
|------------|---------|---------|------|
| 26PK-1605  | 50      | 22      | 3/4" |
| 26PK-2005  | 55      | 26      | 3/4" |
| 26PKW-1605 | 50      | 22      | 3/4" |
| 26PKW-2005 | 55      | 26      | 3/4" |

| ART. NR   | L<br>mm | D1<br>mm | D2<br>mm | G<br>mm | SW<br>mm |
|-----------|---------|----------|----------|---------|----------|
| 26PK-4008 | 103,5   | 47       | 56,5     | 1 1/2"  | 53       |
| 26PK-5010 | 126,5   | 57       | 70       | 2"      | 64       |
| 26PK-6312 | 154,5   | 70       | 88       | 2 1/2"  | 80       |

### TYPE: 27PK

Coude 45°

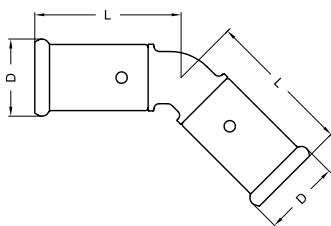

| ART. NR.  | L<br>mm | D<br>mm |
|-----------|---------|---------|
| 27PK-4040 | 63      | 47      |
| 27PK-5050 | 84      | 57      |
| 27PK-6363 | 102     | 70      |



### TYPE: 28PK-04

Attache pour 28PK-2PK1604, 28PK-6PK1604 et 28PK-13PK160416

| ART. NR. | L1  | L2  | L3 | D  | H  |
|----------|-----|-----|----|----|----|
| 28PK-04  | 194 | 153 | 42 | 38 | 26 |

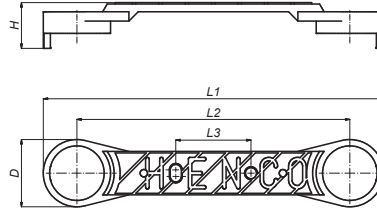

### TYPE: 28PK-2PK1604

Culasse double, entraxe 153mm pour art. 2PK-1604

| Art. Nr.        | L1  | L2  | L3 | D  | H  | TYPE        |
|-----------------|-----|-----|----|----|----|-------------|
| 28PK-2PK1604BP* | 194 | 153 | 42 | 38 | 56 | 2X(16X1/2") |

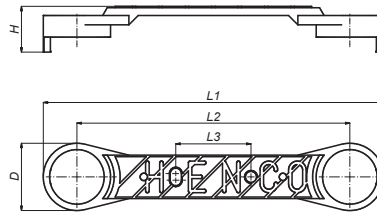

\* Avec bouchon noir BP04 1/2"

### TYPE: 28PK-6PK1604

Culasse double, entraxe 153mm pour art. 6PK-1604

| Art. Nr.        | L1  | L2  | L3 | D  | H  | TYPE        |
|-----------------|-----|-----|----|----|----|-------------|
| 28PK-6PK1604BP* | 194 | 153 | 42 | 38 | 64 | 2X(16X1/2") |

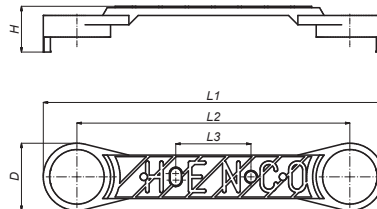

\* Avec bouchon noir BP04 1/2"

### TYPE: 53PK

Raccord montage facile

| ART. NR. | L     | D  |
|----------|-------|----|
| 53PK40   | 179   | 47 |
| 53PK50   | 210,5 | 57 |
| 53PK63   | 236,2 | 70 |

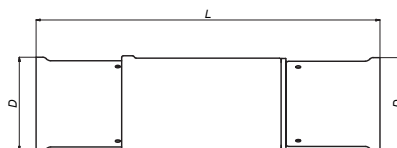



## 9 PROGRAMME DE LIVRAISON

### Henco press gaz

#### TYPE: 1PKG

Coude 90°

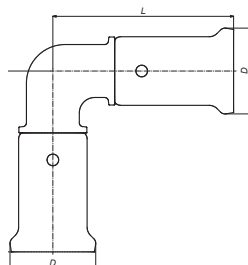

| ART. NR.  | L<br>mm | D<br>mm |
|-----------|---------|---------|
| 1PKG-1616 | 47      | 22      |
| 1PKG-2020 | 49      | 26      |
| 1PKG-2626 | 54      | 32      |
| 1PKG-3232 | 72      | 39      |
| 1PKG-4040 | 78      | 47      |

#### TYPE: 2PKG

Culasse femelle

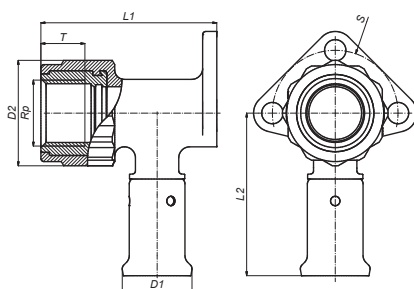

| ART. NR.     | L1<br>mm | L2<br>mm | D1<br>mm | D2<br>mm | Rp   | T<br>mm | S<br>mm |
|--------------|----------|----------|----------|----------|------|---------|---------|
| 2PKG-1603    | 56       | 52       | 22       | 33       | 3/8" | 13,5    | 40      |
| 2PKG-1604BP* | 56       | 52       | 22       | 33       | 1/2" | 13,5    | 40      |
| 2PKG-2004BP* | 56       | 52       | 26       | 33       | 1/2" | 13,5    | 40      |
| 2PKG-2005    | 61       | 58       | 26       | 40       | 3/4" | 15,5    | 46      |
| 2PKG-2605    | 66       | 58       | 32       | 40       | 3/4" | 15,5    | 46      |

\* Avec bouchon noir BP04 1/2"

#### TYPE: 2PKG-K

Culasse femelle, modèle court

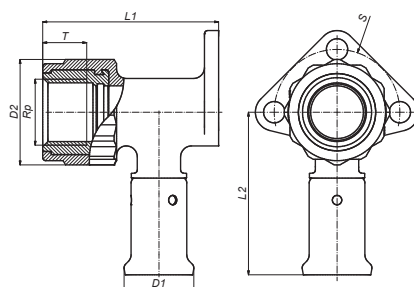

| ART. NR.      | L1<br>mm | L2<br>mm | D1<br>mm | D2<br>mm | Rp   | T<br>mm | S<br>mm |
|---------------|----------|----------|----------|----------|------|---------|---------|
| 2PKG-1604KBP* | 40       | 52       | 22       | 33       | 1/2" | 13,5    | 40      |

\* Avec bouchon noir BP04 1/2"



- 1
- 2
- 3
- 4
- 5
- 6
- 7
- 8
- 9
- 10
- 11

### TYPE: 3PKG

Culasse double pour sanitaire, modèle court

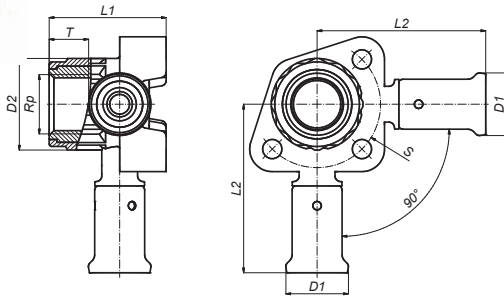

| ART. NR.       | L1 | L2   | D1 | D2 | Rp   | T  | S  |
|----------------|----|------|----|----|------|----|----|
|                | mm | mm   | mm | mm |      | mm | mm |
| 3PKG-160416BP* | 60 | 42   | 22 | 33 | 1/2" | 14 | 45 |
| 3PKG-200420BP* | 60 | 43,5 | 26 | 33 | 1/2" | 14 | 45 |

\* Avec bouchon noir BP04 1/2"

### TYPE: 5PKG

Coude 90° male

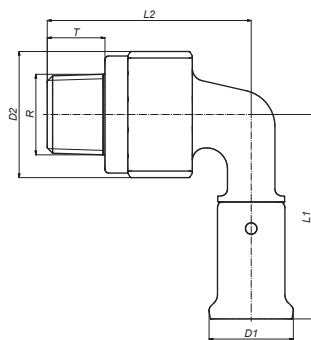

| ART. NR.  | L1 | L2   | D1 | D2   | R    | T    |
|-----------|----|------|----|------|------|------|
|           | mm | mm   | mm | mm   |      | mm   |
| 5PKG-1604 | 54 | 54   | 22 | 33   | 1/2" | 13,5 |
| 5PKG-2004 | 56 | 56   | 26 | 33   | 1/2" | 13,5 |
| 5PKG-2005 | 58 | 58   | 26 | 40   | 3/4" | 14,5 |
| 5PKG-2605 | 60 | 62   | 32 | 40   | 3/4" | 14,5 |
| 5PKG-3206 | 75 | 68,5 | 39 | 45,5 | 1"   | 16,5 |
| 5PKG-4007 | 84 | 77   | 47 | 56,5 | 5/4" | 19   |

### TYPE: 6PKG

Coude 90° femelle

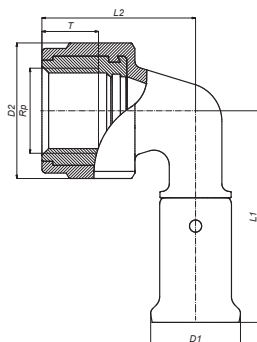

| ART. NR.     | L1 | L2   | D1 | D2   | Rp   | T    |
|--------------|----|------|----|------|------|------|
|              | mm | mm   | mm | mm   |      | mm   |
| 6PKG-1604BP* | 53 | 39   | 22 | 33   | 1/2" | 13,5 |
| 6PKG-2004BP* | 53 | 39   | 26 | 33   | 1/2" | 13,5 |
| 6PKG-2005    | 60 | 47,5 | 26 | 40   | 3/4" | 15,5 |
| 6PKG-2605    | 60 | 47,5 | 32 | 40   | 3/4" | 15,5 |
| 6PKG-3206    | 75 | 58,5 | 39 | 45,5 | 1"   | 18   |
| 6PKG-4007    | 81 | 72   | 47 | 56,5 | 5/4" | 19   |

\* Avec bouchon noir BP04 1/2"

## 9 PROGRAMME DE LIVRAISON

- 1
- 2
- 3
- 4
- 5
- 6
- 7
- 8
- 9
- 10
- 11

### TYPE: 9PKG

Pièce en T

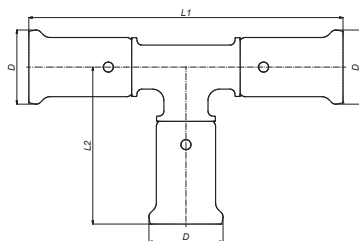

| ART. NR.    | L1<br>mm | L2<br>mm | D<br>mm |
|-------------|----------|----------|---------|
| 9PKG-161616 | 94       | 47       | 22      |
| 9PKG-202020 | 98       | 49       | 26      |
| 9PKG-262626 | 107      | 53       | 32      |
| 9PKG-323232 | 140      | 70       | 39      |
| 9PKG-404040 | 150      | 75       | 47      |

### TYPE: 10PKG

Pièce en T réduit

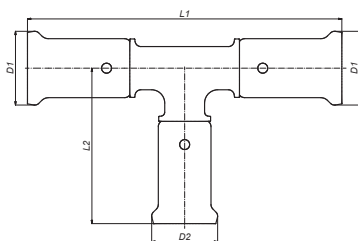

| ART. NR.     | L1<br>mm | L2<br>mm | D1<br>mm | D2<br>mm |
|--------------|----------|----------|----------|----------|
| 10PKG-201620 | 94       | 49       | 26       | 22       |
| 10PKG-261626 | 98       | 53       | 32       | 22       |
| 10PKG-262026 | 103      | 54       | 32       | 26       |
| 10PKG-321632 | 133      | 58       | 39       | 22       |
| 10PKG-321832 | 133      | 58       | 39       | 24       |
| 10PKG-322032 | 133      | 58       | 39       | 26       |
| 10PKG-322632 | 133      | 58       | 39       | 32       |
| 10PKG-401640 | 118      | 59       | 47       | 22       |
| 10PKG-402040 | 122      | 59       | 47       | 26       |
| 10PKG-402640 | 134      | 31       | 47       | 32       |
| 10PKG-403240 | 143      | 75       | 47       | 39       |



## TYPE: 11PKG

Pièce en T 2x réduit

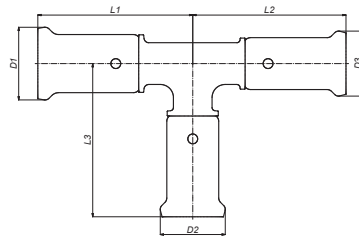

| ART. NR.     | L1<br>mm | L2<br>mm | L3<br>mm | D1<br>mm | D2<br>mm | D3<br>mm |
|--------------|----------|----------|----------|----------|----------|----------|
| 11PKG-201616 | 47,5     | 49,5     | 49,5     | 26       | 22       | 22       |
| 11PKG-202016 | 49,5     | 51       | 49,5     | 26       | 26       | 22       |
| 11PKG-261620 | 51,8     | 51,8     | 53,5     | 32       | 22       | 26       |
| 11PKG-262016 | 51,5     | 51,5     | 53,2     | 32       | 26       | 22       |
| 11PKG-262020 | 51,8     | 51,8     | 54       | 32       | 26       | 26       |
| 11PKG-262616 | 53,5     | 56       | 53,5     | 32       | 32       | 22       |
| 11PKG-262620 | 53,5     | 54,5     | 53,2     | 32       | 32       | 26       |
| 11PKG-322026 | 66,8     | 60       | 58,5     | 39       | 26       | 32       |
| 11PKG-322626 | 66,3     | 60       | 58,5     | 39       | 32       | 32       |
| 11PKG-402032 | 62       | 62       | 59       | 47       | 26       | 39       |
| 11PKG-402632 | 68       | 72       | 61,4     | 47       | 32       | 39       |
| 11PKG-403232 | 70,5     | 70,5     | 72       | 47       | 39       | 39       |
| 11PKG-404026 | 74,5     | 70,5     | 75,5     | 47       | 47       | 32       |
| 11PKG-404032 | 74,5     | 74,5     | 75,5     | 47       | 47       | 39       |

## TYPE: 12PKG

Pièce en T agrandi

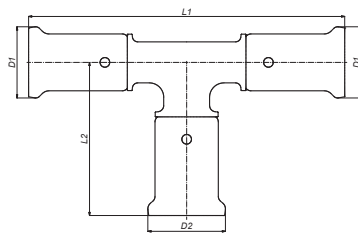

| ART. NR.     | L1<br>mm | L2<br>mm | D1<br>mm | D2<br>mm |
|--------------|----------|----------|----------|----------|
| 12PKG-162016 | 101      | 48,5     | 22       | 26       |
| 12PKG-202620 | 108      | 52       | 26       | 32       |
| 12PKG-263226 | 114      | 66       | 32       | 39       |
| 12PKG-324032 | 145      | 69       | 39       | 47       |

## 9 PROGRAMME DE LIVRAISON

### TYPE: 13PKG

Pièce en T femelle

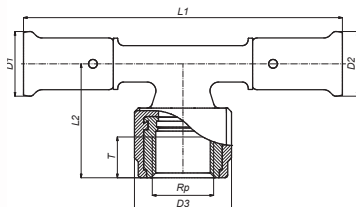

| ART. NR.        | L1  | L2   | D1 | D2 | D3   | Rp   | T    |
|-----------------|-----|------|----|----|------|------|------|
|                 | mm  | mm   | mm | mm | mm   |      | mm   |
| 13PKG-160416BP* | 109 | 39   | 22 | 22 | 33   | 1/2" | 13,5 |
| 13PKG-200420BP* | 109 | 39   | 26 | 26 | 33   | 1/2" | 13,5 |
| 13PKG-200520    | 119 | 47   | 26 | 26 | 40   | 3/4" | 15,5 |
| 13PKG-260420BP* | 109 | 43   | 32 | 26 | 33   | 1/2" | 13,5 |
| 13PKG-260426BP* | 109 | 43   | 32 | 32 | 33   | 1/2" | 13,5 |
| 13PKG-260526    | 119 | 47   | 32 | 32 | 40   | 3/4" | 15,5 |
| 13PKG-320532    | 145 | 52,5 | 39 | 39 | 40   | 3/4" | 15,5 |
| 13PKG-320632    | 147 | 56   | 39 | 39 | 45,5 | 1"   | 16,5 |
| 13PKG-320732    | 161 | 66   | 39 | 39 | 56,5 | 5/4" | 19   |
| 13PKG-400640    | 150 | 63   | 47 | 47 | 45,5 | 1"   | 16,5 |
| 13PKG-400740    | 158 | 69   | 47 | 47 | 56,5 | 5/4" | 19   |

\* Avec bouchon noir BP04 1/2"

### TYPE: 14PKG

Pièce en T mâle

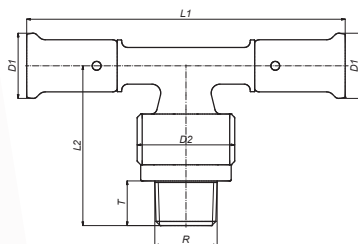

| ART. NR.     | L1  | L2 | D1 | D2   | R    | T    |
|--------------|-----|----|----|------|------|------|
|              | mm  | mm | mm | mm   |      | mm   |
| 14PKG-160416 | 109 | 54 | 22 | 33   | 1/2" | 13,5 |
| 14PKG-200420 | 109 | 54 | 26 | 33   | 1/2" | 13,5 |
| 14PKG-200520 | 114 | 58 | 26 | 40   | 3/4" | 14,5 |
| 14PKG-260426 | 119 | 60 | 32 | 33   | 1/2" | 13,5 |
| 14PKG-260526 | 119 | 63 | 32 | 40   | 3/4" | 14,5 |
| 14PKG-260626 | 124 | 65 | 32 | 45,5 | 1"   | 16,5 |
| 14PKG-320532 | 146 | 66 | 39 | 40   | 3/4" | 14,5 |
| 14PKG-400740 | 159 | 80 | 47 | 56,5 | 5/4" | 19   |

### TYPE: 15PKG

Manchon

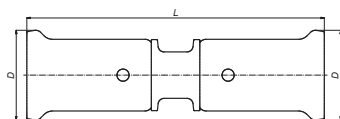

| ART. NR.   | L   | D  |
|------------|-----|----|
|            | mm  | mm |
| 15PKG-1616 | 74  | 22 |
| 15PKG-2020 | 76  | 26 |
| 15PKG-2626 | 81  | 32 |
| 15PKG-3232 | 103 | 39 |
| 15PKG-4040 | 105 | 47 |



### TYPE: 16PKG

Réduction

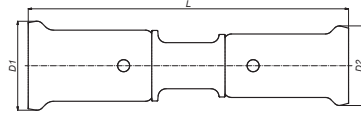

| ART. NR.   | L<br>mm | D1<br>mm | D2<br>mm |
|------------|---------|----------|----------|
| 16PKG-2016 | 80,8    | 26       | 22       |
| 16PKG-2616 | 84      | 32       | 22       |
| 16PKG-2620 | 84      | 32       | 26       |
| 16PKG-3216 | 107     | 39       | 22       |
| 16PKG-3220 | 103     | 39       | 26       |
| 16PKG-3226 | 102     | 39       | 32       |
| 16PKG-4026 | 112     | 47       | 32       |
| 16PKG-4032 | 115     | 47       | 39       |

### TYPE: 17PKG

Raccord droit mâle

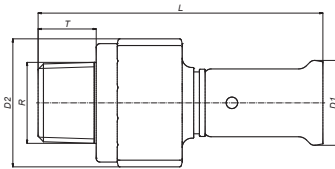

| ART. NR.   | L<br>mm | D1<br>mm | D2<br>mm | R    | T<br>mm |
|------------|---------|----------|----------|------|---------|
| 17PKG-1604 | 75      | 22       | 33       | 1/2" | 13,5    |
| 17PKG-2004 | 75      | 26       | 33       | 1/2" | 13,5    |
| 17PKG-2005 | 77      | 26       | 40       | 3/4" | 14,5    |
| 17PKG-2605 | 77      | 32       | 40       | 3/4" | 14,5    |
| 17PKG-2606 | 80      | 32       | 45,5     | 1"   | 16,5    |
| 17PKG-3206 | 91      | 39       | 45,5     | 1"   | 16,5    |
| 17PKG-3207 | 99      | 39       | 56,5     | 5/4" | 19      |
| 17PKG-4006 | 84      | 47       | 45,5     | 1"   | 16,5    |
| 17PKG-4007 | 91      | 47       | 56,5     | 5/4" | 19      |

### TYPE: 18PKG

Raccord droit femelle

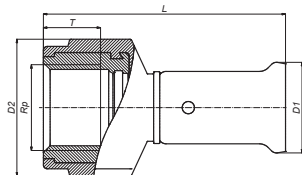

| ART. NR.   | L<br>mm | D1<br>mm | D2<br>mm | Rp   | T<br>mm |
|------------|---------|----------|----------|------|---------|
| 18PKG-1604 | 59,5    | 22       | 33       | 1/2" | 13,5    |
| 18PKG-2004 | 59,5    | 26       | 33       | 1/2" | 13,5    |
| 18PKG-2005 | 63      | 26       | 40       | 3/4" | 15,5    |
| 18PKG-2605 | 63      | 32       | 40       | 3/4" | 15,5    |
| 18PKG-2606 | 70,5    | 32       | 45,5     | 1"   | 18      |
| 18PKG-3206 | 82      | 39       | 45,5     | 1"   | 18      |
| 18PKG-3207 | 90      | 39       | 56,5     | 5/4" | 21      |
| 18PKG-4006 | 73      | 47       | 45,5     | 1"   | 18      |
| 18PKG-4007 | 84      | 47       | 56,5     | 5/4" | 21      |



1

2

3

4

5

6

7

8

9

10

11

### TYPE: 27PKG

Coude 45°

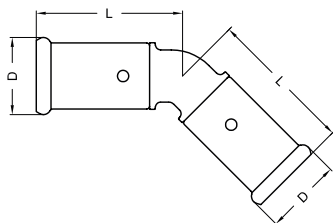

| ART. NR.   | L  | D  |
|------------|----|----|
|            | mm | mm |
| 27PKG-4040 | 63 | 47 |

### TYPE: 30PG

Manchon à sertir vers quivre à sertir

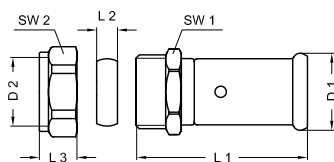

| ART. NR.   | L1   | L2  | L3   | SW1 | SW2 | D1 | D2 |
|------------|------|-----|------|-----|-----|----|----|
|            | mm   | mm  | mm   | mm  | mm  | mm | mm |
| 30PG-1615S | 52,3 | 8   | 12,7 | 22  | 24  | 22 | 15 |
| 30PG-2022S | 53,2 | 8,5 | 14   | 30  | 32  | 26 | 22 |
| 30PG-2622S | 53,2 | 8,5 | 14   | 30  | 32  | 32 | 22 |



## Super Size

### TYPE: 1HN

Coude 90°

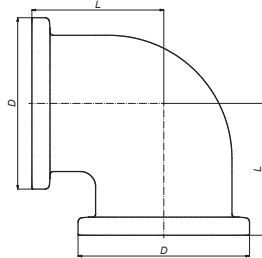

| ART. NR. | L<br>mm | D<br>mm |
|----------|---------|---------|
| 1HNA     | 60      | 78      |
| 1HNB     | 77,5    | 114     |

### TYPE: 8HN

Raccord à sertir

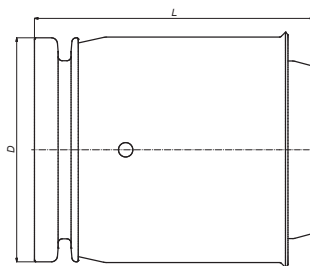

| ART. NR.  | L<br>mm | D<br>mm |
|-----------|---------|---------|
| 8HNA-PK40 | 63,6    | 78      |
| 8HNA-PK50 | 74,5    | 78      |
| 8HNA-PK63 | 84,5    | 78      |
| 8HNA-PK75 | 97,5    | 78      |
| 8HNB-PK90 | 111,8   | 114     |

### TYPE: 9HN

Pièce en T

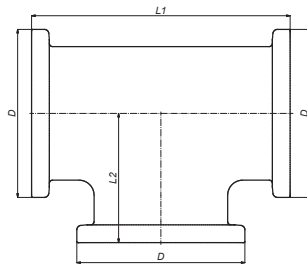

| ART. NR. | L1<br>mm | L2<br>mm | D<br>mm |
|----------|----------|----------|---------|
| 9HNA     | 120      | 60       | 78      |
| 9HNB     | 155      | 77,5     | 114     |

- 1
- 2
- 3
- 4
- 5
- 6
- 7
- 8
- 9
- 10
- 11



## 9 PROGRAMME DE LIVRAISON

1

2

3

4

5

6

7

8

9

10

11

### TYPE: 16HN

Réduction

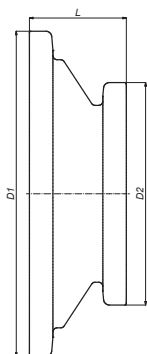

| ART. NR. | L  | D   |
|----------|----|-----|
|          | mm | mm  |
| 16HNBA   | 34 | 114 |

### TYPE: 17HN

Raccord en laiton mâle

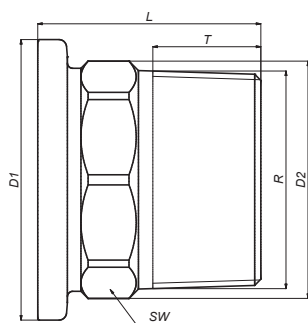

| ART. NR. | L  | D1 | D2 | SW | T  | R    |
|----------|----|----|----|----|----|------|
|          | mm | mm | mm | mm | mm |      |
| 17HNA-10 | 62 | 78 | 66 | 62 | 30 | 2"   |
| 17HNA-12 | 62 | 78 | 80 | 72 | 30 | 2,5" |

### TYPE: 18HN

Raccord en laiton femelle

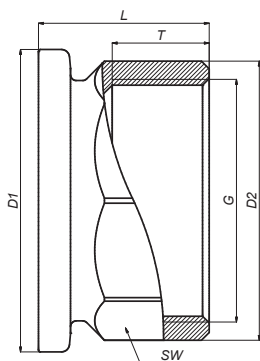

| ART. NR. | L  | D1  | D2  | SW | T    | G    |
|----------|----|-----|-----|----|------|------|
|          | mm | mm  | mm  | mm | mm   |      |
| 18HNA-06 | 40 | 78  | 40  | 38 | 19,5 | 1"   |
| 18HNA-10 | 44 | 78  | 72  | 67 | 25   | 2"   |
| 18HNA-12 | 55 | 78  | 88  | 83 | 30   | 2,5" |
| 18HNB-14 | 44 | 114 | 100 | 96 | 35   | 3"   |



- 1
- 2
- 3
- 4
- 5
- 6
- 7
- 8
- 9
- 10
- 11

**TYPE: 27HN**

Coude 45°

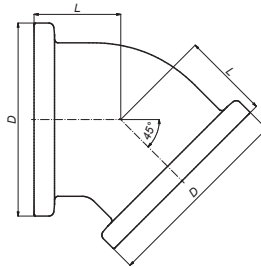

| ART. NR. | L<br>mm | D<br>mm |
|----------|---------|---------|
| 27HNA    | 35      | 78      |
| 27HNB    | 43,6    | 114     |

**TYPE: HN**

Support

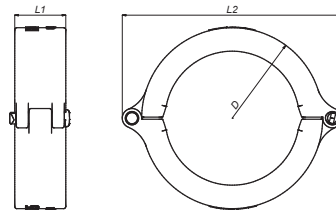

| ART. NR. | L1<br>mm | L2<br>mm | D<br>mm |
|----------|----------|----------|---------|
| HNA      | 23,5     | 102      | 41,6    |
| HNB      | 23,7     | 158      | 120     |

**TYPE: HN-PEN**

Goupille de verrouillage

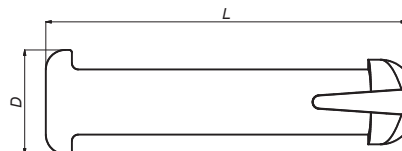

| ART. NR. | L<br>mm | D<br>mm |
|----------|---------|---------|
| HN-PEN   | 27,7    | 8       |

## 9 PROGRAMME DE LIVRAISON

1

2

3

4

5

6

7

8

9

10

11

### TYPE: HN-U

Anneau d'étanchéité



| ART. NR. | L   | D     |
|----------|-----|-------|
|          | mm  | mm    |
| HNA-U    | 6,9 | 67,3  |
| HNB-U    | 6,9 | 102,5 |

### TYPE: HN-STOP

Bouchon d'arrêt Super Size



| ART. NR. | L    | D   |
|----------|------|-----|
|          | mm   | mm  |
| HNA-STOP | 8,25 | 78  |
| HNB-STOP | 8,25 | 114 |



# Henco Vision

## TYPE: 1SK

Coude 90°

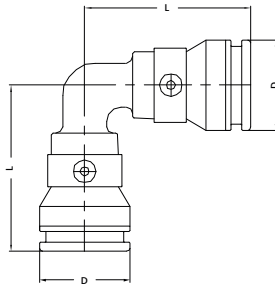

| ART. NR. | L<br>mm | D<br>mm |
|----------|---------|---------|
| 1SK-1616 | 52      | 28      |
| 1SK-2020 | 53      | 33      |
| 1SK-2626 | 59      | 40      |

## TYPE: 2SK

Culasse pour sanitaire femelle

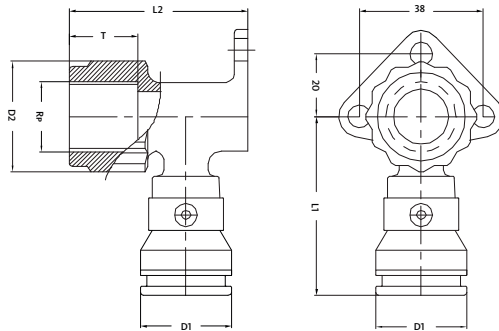

| ART. NR.    | L1<br>mm | L2<br>mm | D1<br>mm | D2<br>mm | Rp   | T<br>mm |
|-------------|----------|----------|----------|----------|------|---------|
| 2SK-1604BP* | 54       | 55       | 28       | 33       | 1/2" | 14      |
| 2SK-2004BP* | 57       | 60       | 33       | 33       | 1/2" | 14      |
| 2SK-2005    | 62       | 61       | 33       | 40       | 3/4" | 16      |
| 2SK-2605    | 63       | 66       | 40       | 40       | 3/4" | 16      |

\* Avec bouchon noir BP04 1/2"

- 1
- 2
- 3
- 4
- 5
- 6
- 7
- 8
- 9
- 10
- 11

## 9 PROGRAMME DE LIVRAISON

1  
2  
3  
4  
5  
6  
7  
8  
9  
10  
11

### TYPE: 3SK

Culasse double pour sanitaire, modèle court

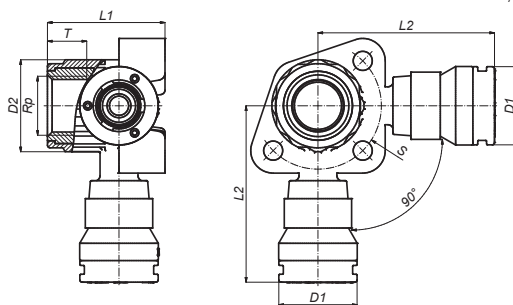

| ART. NR.      | L1<br>mm | L2<br>mm | D1<br>mm | D2<br>mm | Rp<br>mm | T<br>mm |
|---------------|----------|----------|----------|----------|----------|---------|
| 3SK-160416BP* | 62       | 42       | 28       | 33       | 1/2"     | 14      |
| 3SK-200420BP* | 62       | 44       | 33       | 33       | 1/2"     | 14      |

\* Avec bouchon noir BP04 1/2"

### TYPE: 5SK

Coude 90° mâle

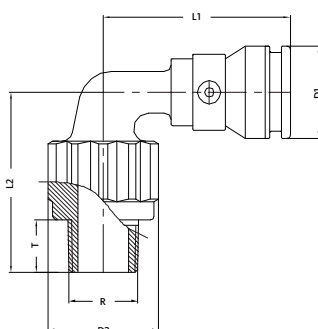

| ART. NR. | L1<br>mm | L2<br>mm | D1<br>mm | D2<br>mm | R<br>mm | T<br>mm |
|----------|----------|----------|----------|----------|---------|---------|
| 5SK-1604 | 57       | 54       | 28       | 33       | 1/2"    | 14      |
| 5SK-2004 | 60       | 57       | 33       | 33       | 1/2"    | 14      |
| 5SK-2005 | 63       | 58       | 33       | 40       | 3/4"    | 16      |
| 5SK-2605 | 64       | 62       | 40       | 40       | 3/4"    | 16      |

### TYPE: 6SK

Coude 90° femelle

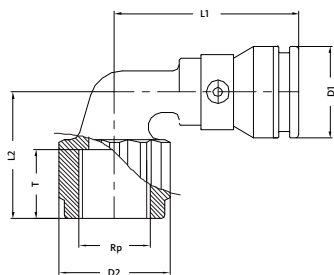

| ART. NR.    | L1<br>mm | L2<br>mm | D1<br>mm | D2<br>mm | Rp<br>mm | T<br>mm |
|-------------|----------|----------|----------|----------|----------|---------|
| 6SK-1604BP* | 56       | 40       | 28       | 33       | 1/2"     | 14      |
| 6SK-2004BP* | 58       | 40       | 33       | 33       | 1/2"     | 14      |
| 6SK-2005    | 63       | 48       | 33       | 40       | 3/4"     | 16      |
| 6SK-2605    | 65       | 48       | 40       | 40       | 3/4"     | 16      |

\* Avec bouchon noir BP04 1/2"



### TYPE: 9SK

Pièce en T

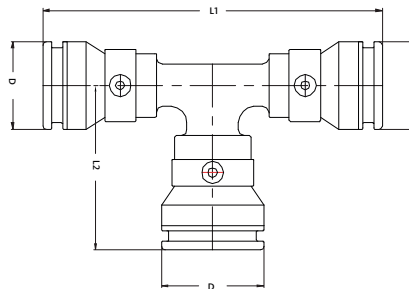

| ART. NR.   | L1<br>mm | L2<br>mm | D<br>mm |
|------------|----------|----------|---------|
| 9SK-161616 | 101      | 50,5     | 28      |
| 9SK-202020 | 106,5    | 53       | 33      |
| 9SK-262626 | 117      | 59       | 40      |

### TYPE: 10SK

T-réduit

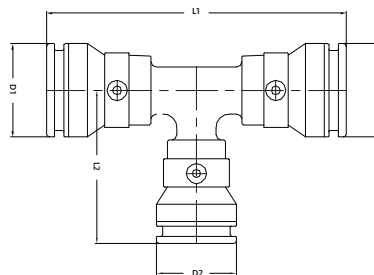

| ART. NR.    | L1<br>mm | L2<br>mm | D1<br>mm | D2<br>mm |
|-------------|----------|----------|----------|----------|
| 10SK-201620 | 103      | 53       | 33       | 28       |
| 10SK-261626 | 109      | 57       | 40       | 28       |
| 10SK-262026 | 113      | 57       | 40       | 33       |

### TYPE: 11SK

T-2X réduit

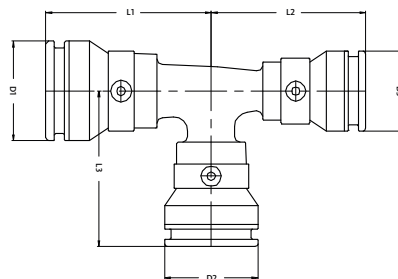

| ART. NR.    | L1<br>mm | L2<br>mm | L3<br>mm | D1<br>mm | D2<br>mm | D3<br>mm |
|-------------|----------|----------|----------|----------|----------|----------|
| 11SK-201616 | 52       | 52       | 52       | 33       | 28       | 28       |
| 11SK-202016 | 55       | 53       | 53       | 33       | 33       | 28       |
| 11SK-261620 | 56       | 54       | 54       | 40       | 28       | 33       |
| 11SK-262016 | 57       | 55       | 57       | 40       | 33       | 28       |
| 11SK-262020 | 57       | 56       | 57       | 40       | 33       | 33       |
| 11SK-262616 | 60       | 58       | 58       | 40       | 40       | 28       |
| 11SK-262620 | 59       | 58       | 58       | 40       | 40       | 33       |

## 9 PROGRAMME DE LIVRAISON

1  
2  
3  
4  
5  
6  
7  
8  
9  
10  
11

### TYPE: 12SK

T-agrandi

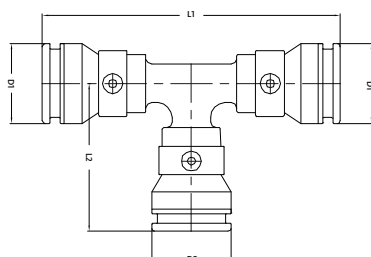

| ART. NR.    | L1<br>mm | L2<br>mm | D1<br>mm | D2<br>mm |
|-------------|----------|----------|----------|----------|
| 12SK-162016 | 108      | 53       | 28       | 33       |
| 12SK-202620 | 116      | 57       | 33       | 40       |

### TYPE: 13SK

T-femelle

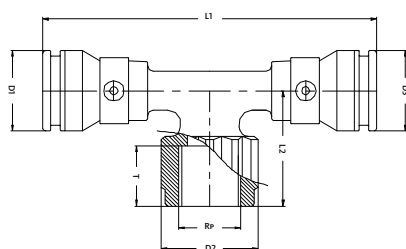

| ART. NR.       | L1<br>mm | L2<br>mm | L3<br>mm | D1<br>mm | D2<br>mm | D3<br>mm | Rp   | T<br>mm |
|----------------|----------|----------|----------|----------|----------|----------|------|---------|
| 13SK-160416BP* | 116      | 39       | 28       | 33       | 28       | 28       | 1/2" | 14      |
| 13SK-200420BP* | 117      | 39       | 33       | 33       | 33       | 33       | 1/2" | 14      |
| 13SK-200520    | 120      | 45       | 33       | 40       | 33       | 33       | 3/4" | 16      |
| 13SK-260420BP* | 118      | 42       | 40       | 33       | 33       | 33       | 1/2" | 14      |
| 13SK-260426BP* | 120      | 42       | 40       | 33       | 40       | 40       | 1/2" | 14      |
| 13SK-260526    | 121      | 44       | 40       | 40       | 40       | 40       | 3/4" | 16      |

\* Avec bouchon noir BP04 1/2"

### TYPE: 14SK

T-mâle

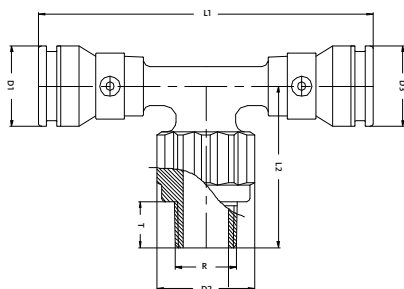

| ART. NR.    | L1<br>mm | L2<br>mm | D1<br>mm | D2<br>mm | D3<br>mm | R    | T<br>mm |
|-------------|----------|----------|----------|----------|----------|------|---------|
| 14SK-160416 | 111      | 54       | 28       | 33       | 28       | 1/2" | 14      |
| 14SK-200420 | 111      | 54       | 33       | 33       | 33       | 1/2" | 14      |
| 14SK-260426 | 116      | 57       | 40       | 33       | 40       | 1/2" | 14      |



- 1
- 2
- 3
- 4
- 5
- 6
- 7
- 8
- 9
- 10
- 11

### TYPE: 15SK

Manchon

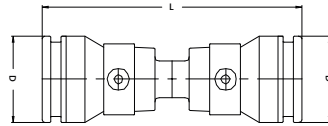

| ART. NR.  | L<br>mm | D<br>mm |
|-----------|---------|---------|
| 15SK-1616 | 83,5    | 28      |
| 15SK-2020 | 85      | 33      |
| 15SK-2626 | 90      | 40      |

### TYPE: 16SK

Réduction

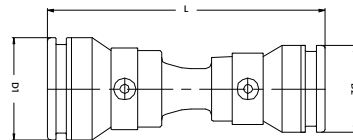

| ART. NR.  | L<br>mm | D1<br>mm | D2<br>mm |
|-----------|---------|----------|----------|
| 16SK-2016 | 89      | 33       | 28       |
| 16SK-2616 | 93      | 40       | 28       |
| 16SK-2620 | 93      | 40       | 33       |

### TYPE: 17SK

Raccord droit mâle

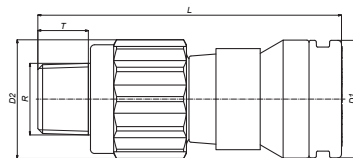

| ART. NR.  | L<br>mm | D1<br>mm | D2<br>mm | R    | T  |
|-----------|---------|----------|----------|------|----|
| 17SK-1603 | 72      | 28       | 28       | 3/8" | 14 |
| 17SK-1604 | 76      | 28       | 33       | 1/2" | 14 |
| 17SK-2004 | 76,5    | 33       | 33       | 1/2" | 14 |
| 17SK-2005 | 78      | 33       | 40       | 3/4" | 16 |
| 17SK-2605 | 80      | 40       | 40       | 3/4" | 16 |
| 17SK-2606 | 82      | 40       | 46       | 1"   | 18 |



## 9 PROGRAMME DE LIVRAISON

1

2

3

4

5

6

7

8

9

10

11

### TYPE: 18SK

Raccord droit femelle

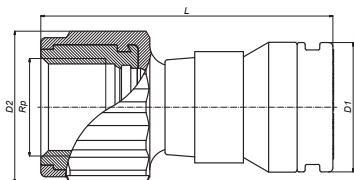

| ART. NR.  | L<br>mm | D1<br>mm | D2<br>mm | R    | T  |
|-----------|---------|----------|----------|------|----|
| 18SK-1604 | 64      | 28       | 33       | 1/2" | 14 |
| 18SK-2004 | 63      | 33       | 33       | 1/2" | 14 |
| 18SK-2005 | 68      | 33       | 40       | 3/4" | 16 |
| 18SK-2605 | 67      | 40       | 40       | 3/4" | 16 |
| 18SK-2606 | 70      | 40       | 46       | 1"   | 18 |

### TYPE: 19SK

Raccord push fit avec eurocone

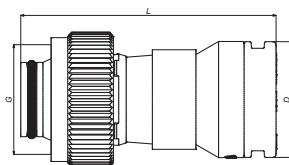

| ART. NR.  | L<br>mm | D<br>mm | G<br>mm |
|-----------|---------|---------|---------|
| 19SK-1605 | 62      | 28      | 3/4"    |
| 19SK-2005 | 62      | 33      | 3/4"    |

### TYPE: 26SK

Raccord push fit avec etanchéité plate

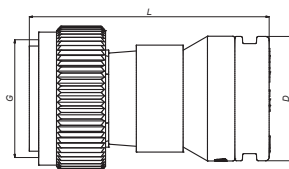

| ART. NR.  | L<br>mm | D<br>mm | G<br>mm |
|-----------|---------|---------|---------|
| 26SK-1605 | 60      | 28      | 3/4"    |
| 26SK-2005 | 62      | 33      | 3/4"    |



- 1
- 2
- 3
- 4
- 5
- 6
- 7
- 8
- 9
- 10
- 11

### TYPE: SK-PIESTOP

Bouchon pour tube

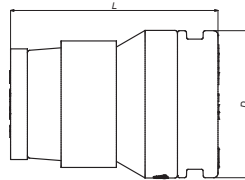

| ART. NR.     | L<br>mm | D<br>mm |
|--------------|---------|---------|
| SK-PIESTOP16 | 40      | 28      |
| SK-PIESTOP20 | 40      | 33      |
| SK-PIESTOP26 | 42      | 40      |

### TYPE: STOPCLIP

Bouchon et clip réutilisables pour connection push fit

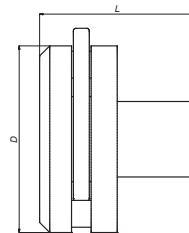

| ART. NR.      | L<br>mm | D<br>mm |
|---------------|---------|---------|
| SK-STOPCLIP16 | 29      | 35      |
| SK-STOPCLIP20 | 30      | 40      |
| SK-STOPCLIP26 | 30      | 49      |

### TYPE: VISIONSET

Set de révision Vision

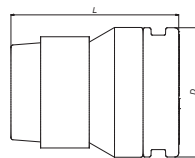

| ART. NR.      | L<br>mm | D<br>mm |
|---------------|---------|---------|
| VISION SET 16 | 36      | 28      |
| VISION SET 20 | 37      | 33      |
| VISION SET 26 | 38      | 40      |

### TYPE: VISION KEY

Clé de démontage Vision



| ART. NR.      | L<br>mm | D<br>mm |
|---------------|---------|---------|
| VISION KEY 16 | 145     | 16      |
| VISION KEY 20 | 145     | 20      |
| VISION KEY 26 | 145     | 26      |

## 9 PROGRAMME DE LIVRAISON

### Henco Vision Collecteurs

#### TYPE: VSK-1616

Complément ou base collecteur, deux sorties SK Ø16

| ART. NR. | L1  | L2 | L3 | D1 | D2 | T              |
|----------|-----|----|----|----|----|----------------|
| VSK-1616 | 100 | 50 | 50 | 30 | 28 | Special thread |

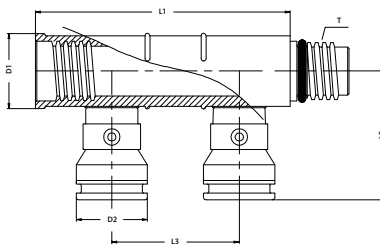

#### TYPE: VSK-161616

Complément ou base collecteur, trois sorties SK Ø16

| ART. NR.   | L1  | L2 | L3 | D1 | D2 | T              |
|------------|-----|----|----|----|----|----------------|
| VSK-161616 | 150 | 50 | 50 | 30 | 28 | Special thread |

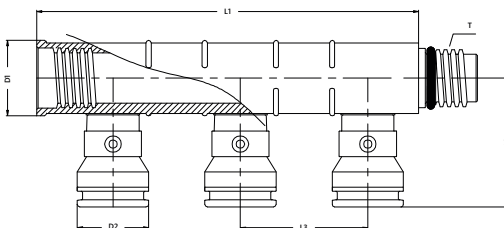

#### TYPE: VSKEK-0502

Complément ou base collecteur, deux sorties eurocone

| ART. NR.   | L1  | L2 | L3 | D1   | D2   | G    | T              |
|------------|-----|----|----|------|------|------|----------------|
| VSKEK-0502 | 100 | 30 | 50 | 29,5 | 29,8 | 3/4" | Special thread |

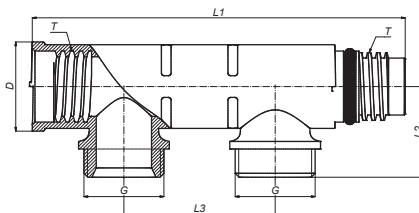



### TYPE: VSKEK-0503

Complément ou base collecteur, trois sorties eurocone

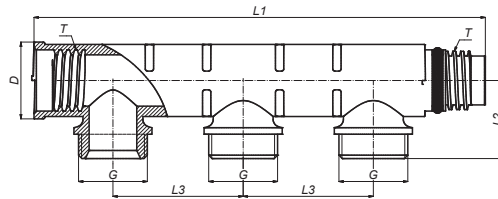

| ART. NR.   | L1    | L2 | L3 | D    | G    | T              |
|------------|-------|----|----|------|------|----------------|
|            | mm    | mm | mm | mm   |      |                |
| VSKEK-0503 | 149,5 | 30 | 50 | 29,5 | 3/4" | Special thread |

### TYPE: 19SK

Raccord push fit avec eurocone

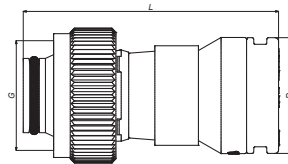

| ART. NR.  | L  | D  | G    |
|-----------|----|----|------|
|           | mm | mm |      |
| 19SK-1605 | 62 | 28 | 3/4" |
| 19SK-2005 | 62 | 33 | 3/4" |

### TYPE: VVSK

Arrivée pour collecteur

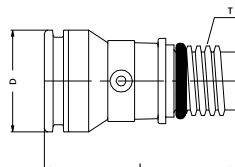

| ART. NR. | L  | D  | T              |
|----------|----|----|----------------|
|          | mm | mm |                |
| VVSK-20  | 63 | 33 | Special thread |
| VVSK-26  | 62 | 40 | Special thread |

## 9 PROGRAMME DE LIVRAISON

1

2

3

4

5

6

7

8

9

10

11

### TYPE: VVSK-TM

Pièce en T pour le départ d'un collecteur Vision

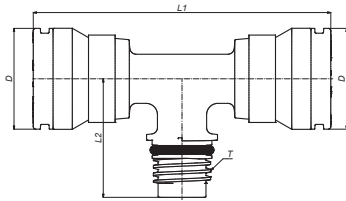

| ART. NR.    | L1    | L2    | D  | T              |
|-------------|-------|-------|----|----------------|
|             | mm    | mm    | mm |                |
| VVSK-T26M26 | 117,5 | 46,65 | 40 | Special thread |

### TYPE: 17SKS

Raccord droit mâle

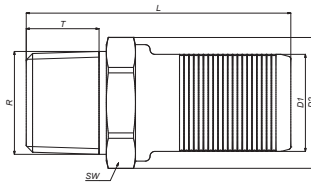

| ART. NR.   | L    | D1 | D2 | R    | SW |
|------------|------|----|----|------|----|
|            | mm   | mm | mm |      | mm |
| 17SKS-2004 | 54,5 | 20 | 27 | 1/2" | 24 |
| 17SKS-2005 | 56   | 20 | 30 | 3/4" | 27 |
| 17SKS-2604 | 54,6 | 26 | 34 | 1/2" | 30 |
| 17SKS-2605 | 56   | 26 | 34 | 3/4" | 30 |

### TYPE: 18SKS

Raccord droit femelle

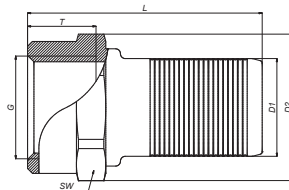

| ART. NR.   | L    | D1 | D2 | R    | SW |
|------------|------|----|----|------|----|
|            | mm   | mm | mm |      | mm |
| 18SKS-2004 | 48   | 20 | 30 | 1/2" | 27 |
| 18SKS-2005 | 53   | 20 | 36 | 3/4" | 32 |
| 18SKS-2604 | 47   | 26 | 34 | 1/2" | 30 |
| 18SKS-2605 | 50,3 | 26 | 36 | 3/4" | 32 |



- 1
- 2
- 3
- 4
- 5
- 6
- 7
- 8
- 9
- 10
- 11

**TYPE: VVSK-90**

Courbe 90° pour collecteur

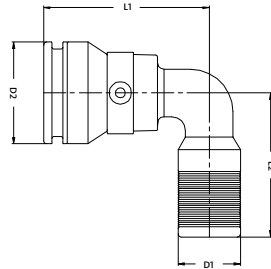

| ART. NR.   | L1 | L2 | D1 | D2 |
|------------|----|----|----|----|
|            | mm | mm | mm | mm |
| VVSK-20-90 | 52 | 47 | 20 | 33 |
| VVSK-26-90 | 60 | 51 | 26 | 40 |

**TYPE: VVSK-T**

T pour collecteur

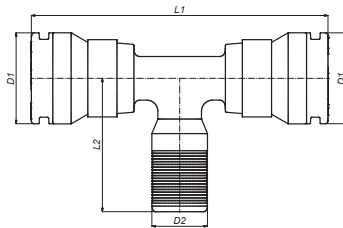

| ART. NR.     | L1    | L2   | D1 | D2 |
|--------------|-------|------|----|----|
|              | mm    | mm   | mm | mm |
| VVSK-T202020 | 106,8 | 46,6 | 33 | 20 |
| VVSK-T262626 | 120   | 50,8 | 40 | 26 |

**TYPE: VS-ENDCAP**

Bouchon femelle pour collecteur

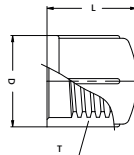

| ART. NR.  | L  | D  | T  |
|-----------|----|----|----|
|           | mm | mm |    |
| VS-ENDCAP | 29 | 30 | 26 |

## 9 PROGRAMME DE LIVRAISON

1

2

3

4

5

6

7

8

9

10

11

### TYPE: VS-ENDCAP-M

Bouchon mâle pour collecteur

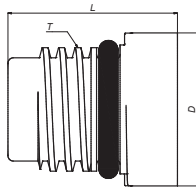

| ART. NR.    | L  | D  | T              |
|-------------|----|----|----------------|
|             | mm | mm |                |
| VS-ENDCAP-M | 31 | 28 | Special thread |

### TYPE: VDSK

Manchon pour bout de collecteur

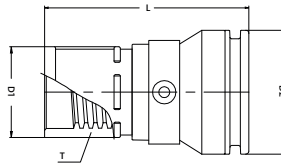

| ART. NR. | L  | D1 | D2 | T              |
|----------|----|----|----|----------------|
|          | mm | mm | mm |                |
| VDSK-20  | 68 | 30 | 33 | Special thread |
| VDSK-26  | 65 | 30 | 40 | Special thread |

### TYPE: STOPCLIP

Bouchon et clip réutilisables pour connection push fit

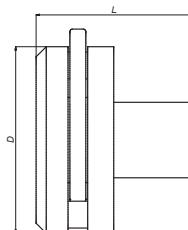

| ART. NR.      | L  | D  |
|---------------|----|----|
|               | mm | mm |
| SK-STOPCLIP16 | 29 | 35 |
| SK-STOPCLIP20 | 30 | 40 |
| SK-STOPCLIP26 | 30 | 49 |



## TYPE: SK-B05

Support double pour collecteurs Vision

| ART. NR. | L1  | L2  | L3 | L4 | H1   | H2   |
|----------|-----|-----|----|----|------|------|
| SK-B05   | 250 | 200 | 75 | 20 | 45,5 | 18,5 |

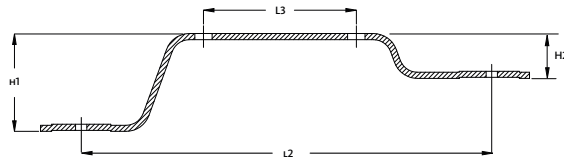
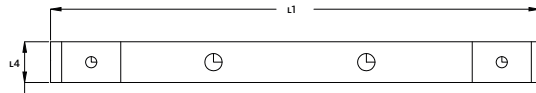

- 1
- 2
- 3
- 4
- 5
- 6
- 7
- 8
- 9
- 10
- 11